



# Caterer's Warehouse 2023 Catalog

**Due to Market Price Fluctuations**

Current Pricing is Available at [www.catererswarehouse.com](http://www.catererswarehouse.com)



**A Showcase of Specialty Products for the  
Hospitality, Catering, and Event Planning Industries!**

**Online Purchasing Program:**

**Buy Big and Save!**

Place any Order in 2023 and  
Use Code "**ONLINE23**" and Get an Extra:

- 3% off any order subtotal of \$450.00 or more
- 5% off any order subtotal of \$950.00 or more
- 8% off any order subtotal of \$1,500.00 or more

**WWW.CATERERSWAREHOUSE.COM**





# Caterer's Warehouse

At Progressive Pro/Caterer's Warehouse Inc., we're proud to be one of America's Leading sources for wholesale catering supplies, foodservice equipment, and hard to find niche products for the hospitality, party rental, bakery, bridal, and other foodservice industries! We carry an endless selection of over 18,000 products, to fill everyday equipment supply needs. Whether you're a busy large commercial establishment or an at-home cook, you can be sure you will find something that will work for your specialty needs. Our vision is to be a fast, easy, and cost-effective one-stop shopping destination for all your catering, party, and equipment needs!

With our new 2020 catalog and online programs, you can access thousands of products across a wide array of product categories allowing you to see the vast offerings of specialty products available! Don't see a product on our website or just have a question relating to an item? You can request information online at [www.catererswarehouse.com](http://www.catererswarehouse.com) or just pick up the phone and call us! Our knowledgeable equipment specialists are here to assist you with a single purchase or a complete new store opening.

If you are in need of an expedited order, we can ship Next Day, Second Day, Third Day and Standard Ground. Also special LTL Carrier "Freight Time Guarantee" is available upon request. Additional Charges Will Apply to any order, per personalized shipping requests.

**Personalization & Customization  
On Selected Products is also  
available, Call For Details!**

## Place an Order:

Online: [www.Catererswarehouse.com](http://www.Catererswarehouse.com) or Mobile  
 Phone: 1-508-892-9618  
 Fax : 1-508-892-9745  
 Mail: Send in your orders to us at:  
 Caterer's Warehouse Attn: Sales, P.O. Box 400, Rochdale, MA 01542

## Terms and Conditions

- \* Terms and Conditions are available on the website at [www.catererswarehouse.com](http://www.catererswarehouse.com)
- \* All items are subject to product availability
- \* Cancellation of previous orders prohibited
- \* Prices are subject to change without notice
- \* Payment term options are prepaid with Cash, Check, Credit Card, Wire Transfer, Money Order, Certified Bank Check, Pay Pal, and approved business credit terms

# Table of Contents

Cake/Display Stands.....	3-5
Display & Serving Trays.....	6-7
Trays & Tray Stands.....	8-12
Charger Plates & Napkin Rings.....	13-15
Baskets.....	16-17
Bowls.....	17-21
Ice Buckets, Party Tubs, & Wine Coolers.....	22-24
Bar Supplies, Chillers, & Cocktail Shakers.....	25-26
Mint Julep Cups & Tankards.....	27
Mule Mugs & Drinkware.....	28
Glassware.....	29-43
Glass Polisher, Glass Washer, & Fill N' Chill Tables.....	43
Cooler Cart, Dish Caddies, & Portable Bars.....	44
Ice Caddies, Service Carts, Bus Boxes, & Work Station.....	45
Food Bars & Insulated Beverage Servers.....	46
Insulated Carriers & Signs.....	47
Coffee Urns & Coffee Makers & Accessories.....	48-49
Beverage Dispensers & Accessories.....	50-51
Beverage Servers, Creamers & Sugar Bowls.....	52-54
Water Pitchers, Decanters & Carafes.....	53-57
Chafers & Chafers Storage Boxes.....	57-62
Soup Chafers.....	63
Food Containers, Food Pans, Food Warmers, & Griddles.....	63-64
Heat Lamps, Hot Dog Steamer, & Hot Dog Roller Grill.....	65
Convection Ovens, Microwaves, & Ranges.....	66
Proofers.....	67
Pan Racks & Sheet Pans.....	68
Confection Machines & Pizza Ovens.....	69
Cookware.....	69-70
Kitchenware & Cutlery Holders.....	71-72
Serving Pieces.....	73-80
Knives.....	81-85
Flatware.....	86-106
Flatware Burnishers & Flatware Polishers.....	107
Condiment Supplies.....	108-110
Vases.....	110
Cleaning Products, Napkin Rings, & Number Card Holders.....	111
Candelabras, Tealight Holders, & Votives.....	112-113
Dinnerware.....	114-131
Plate Covers.....	132
Warewashing Racks & Dollies.....	133-142
Disposable Products.....	143-145
Professional Apparel.....	145
Table Linens, Tablecloths, & Table Skirting.....	146-149
Booster Seats, High Chairs, Garment Racks, & Hangers.....	149
Chairs & Chair Pads.....	150
Tables & Dollies.....	151

## 100+ New Items



# CAKE/DISPLAY STANDS

### CAKE STANDS

HAMMERED TOP, NON-TARNISH.



- AC-9118 6" DIA. ROUND NICKELPLATE
- AC-9120 10" DIA. ROUND NICKELPLATE
- AC-9121 12" DIA. ROUND NICKELPLATE
- AC-9122 14" DIA. ROUND NICKELPLATE
- AC-9129 16" DIA. ROUND NICKELPLATE
- AC-9123 18" DIA. ROUND NICKELPLATE
- AC-9124 22" DIA. ROUND NICKELPLATE
- AC-9119 23.5" DIA. ROUND NICKELPLATE

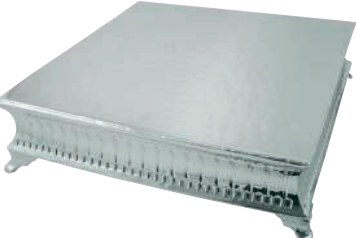

- AC-9125 14"x14" SQUARE NICKELPLATE
- AC-9126 16"x16" SQUARE NICKELPLATE
- AC-9127 18"x16" SQUARE NICKELPLATE
- AC-9128 22"x22" SQUARE NICKELPLATE



- ACG-9122 14" DIA. ROUND GOLDPLATE
- ACG-9129 16" DIA. ROUND GOLDPLATE
- ACG-9123 18" DIA. ROUND GOLDPLATE
- ACG-9124 22" DIA. ROUND GOLDPLATE



- ACG-9127 18" SQUARE GOLDPLATE



- ACW-9129 16" DIA. ROUND
- ACW-9123 18" DIA. ROUND
- ACW-9124 22" DIA. ROUND
- ACW-9127 18" SQUARE



- CAKE STANDS (WHITE POWDER COATED)  
HAMMERED TOP WITH CONTEMPORARY DESIGN ON SIDES. NON-TARNISH.
- ACSP-4750 12.5" DIA. x 3" H.

### CAKE STANDS

SCROLLED FLORAL DESIGN, NON-TARNISH.



- AC-88514 14" DIA. ROUND NICKELPLATE
- AC-88516 16" DIA. ROUND NICKELPLATE
- AC-88518 18" DIA. ROUND NICKELPLATE
- AC-88522 22" DIA. ROUND NICKELPLATE
- AC-88524 23.5" DIA. ROUND NICKELPLATE



- ACG-88514 14" DIA. ROUND GOLDPLATE
- ACG-88516 16" DIA. ROUND GOLDPLATE
- ACG-88518 18" DIA. ROUND GOLDPLATE
- ACG-88522 22" DIA. ROUND GOLDPLATE



- AC-87714 14"x14" SQUARE NICKELPLATE
- AC-87716 16"x16" SQUARE NICKELPLATE
- AC-87718 18"x18" SQUARE NICKELPLATE
- AC-87722 22"x22" SQUARE NICKELPLATE



- ACG-87718 18" SQUARE, GOLDPLATE



- CAKE STAND (NICKELPLATED)
- AC-89950 18" DIA. ROUND, 6" H., NICKELPLATE
- ACG-89951 14" DIA. ROUND, 6" H., NICKELPLATE
- AC-89951 14" DIA. ROUND, 6" H., NICKELPLATE
- AC-89952 16" DIA. ROUND, 6" H., NICKELPLATE



- CAKE STAND
- THESE CAKE STANDS HAVE A THICK BANDED, SUPPORTED BY BALLED FEET AND STAND FEATURES FAUX CRYSTALS ON THE OUTSIDE RIM.

- AC-27766 19 1/2" DIA. X 4.5" H. STAINLESS
- ACG-27766 19 1/2" DIA. X 4.5" H. GOLDPLATE



- SOPRANO CAKE STAND WITH BASE (STAINLESS STEEL)
- ACSS-342 14" W. X 5" H., 5" W. BASE

### SET OF 3 CAKE STANDS (COPPER FINISH WITH WOOD TOP)

THESE CAKE STANDS HAVE A BEAUTIFUL COPPER FINISH AND A RUSTIC WOOD TOP. THEY ARE SOLD AS A SET OF THREE ONLY.



- ACC-4750 12", 15" AND 19" DIA. ROUND
- ACC-4751 13", 15" AND 20" SQUARE



### SET OF 3 CAKE STANDS (SILVER FINISH WITH WOOD TOP)

THESE CAKE STANDS HAVE A BEAUTIFUL COPPER FINISH AND A RUSTIC WOOD TOP. THEY ARE SOLD AS A SET OF THREE ONLY.



- ACS-4750 12", 15" AND 19" DIA. ROUND
- ACS-4751 13", 15" AND 20" SQUARE



### SET OF 3 CAKE STANDS (GOLD FINISH WITH WOOD TOP)

THESE CAKE STANDS HAVE A BEAUTIFUL COPPER FINISH AND A RUSTIC WOOD TOP. THEY ARE SOLD AS A SET OF THREE ONLY.



- ACG-4750 12", 15" AND 19" DIA. ROUND
- ACG-4751 13", 15" AND 20" SQUARE



- CAKE STAND (GOLDPLATE)
- ACG-89950 18" DIA. ROUND, 6" H., GOLDPLATE
- ACG-89951 14" DIA. ROUND, 6" H., GOLDPLATE
- ACG-89961 16" DIA. ROUND, 6" H., GOLDPLATE



### FOOTED GLASS PLATE/STAND WITH BEADED EDGE

- GAC-300 8" DIA. GOLD BEADED EDGE
- GAC-301 13" DIA. GOLD BEADED EDGE
- GAC-310 8" DIA. SILVER BEADED EDGE
- GAC-311 13" DIA. SILVER BEADED EDGE



### CAKE STANDS & COVERS COVER SOLD SEPARATELY.

- AC-4225 13" DIA. CAKE STAND STAINLESS
- AC-4226 COVER FITS AC-4225 ACRYLIC
- ACC-4225 12" DIA. CAKE STAND CHROME
- ACC-4226 COVER FITS ACC-4225 ACRYLIC

### SUPER WHITE CAKE STANDS (SUPER WHITE PORCELAIN)



- ACP-800 8" X 2 3/4" COUPE PLATE CAKE STAND
- ACP-801 10" X 3" CAKE COUPE PLATE CAKE STAND
- ACP-802 12" X 4" FLAT PLATE CAKE STAND



- CASE PACK 8 EACH
- 6 EACH
- 6 EACH



### CAKE STAND WITH GOLD BEAD EDGE (GALVANIZED) SOLD IN CASE PACKS OF TWO ONLY.

- AC-5470 SUNBURST TOP 13.5" DIA. X 6.75" H.
- AC-5471 DOWNWARD LIP 12" DIA. X 7.5" H.



# CAKE/DISPLAY STANDS

**GLASS CAKE STAND**  
SOLD IN THE CASE OF TWO ONLY.  
GAC-25137 12 3/4" DIA. FLUTED TOP  
GAC-25138 12 3/4" DIA. FLUTED BOTTOM

**MIRROR PEDESTAL CAKE STAND (ACRYLIC)**  
ACM-1300 13" DIA. X 4" H.  
MIRRORED SURFACE

**MEDERA CAKE PEDESTAL**  
IT IS CONSTRUCTED OF RECLAIMED WOOD AND A BLACK POWDER COATED BASE.  
HAND WASH ONLY.  
ACW-3450 13" DIA. X 4 1/2" H.

**TRIFLE BOWLS (DISPOSABLE)**  
SOLD IN CASE PACKS ONLY.  
CASE PACK 6 EACH  
DP-4560 6" DIA.  
DP-4561 7.5" DIA.

**MIRROR DISPLAY TRAYS (ACRYLIC)**  
MADE OF LIGHT WEIGHT ACRYLIC. DISPLAYS HAVE A UNIQUE DOUBLE SIDED SURFACE FEATURE WHICH ALLOWS THE USER TO DISPLAY EITHER THE MIRRORED OR SOLID BLACK SIDE.

MTR-1307 24" OCTAGON  
MTR-1317 24"x16" RECTANGLE  
MTR-1318 36"x18" RECTANGLE  
MTR-1319 48"x24" RECTANGLE  
MTR-1320 12" DIA. ROUND  
MTR-1322 24" DIA. ROUND  
MTR-1331 24" YIN/YANG SET/2

**3 PIECE RISER SET (STAINLESS STEEL)**  
AR-CRH3 HAMMERED FINISH  
AR-CRS3 SATIN FINISH

3 PIECE RISER SET  
LARGE: 12.5" L. X 6" W. X 6.5" H.  
MIDDLE: 10.5" L. X 5.25" W. X 4" H.  
SMALL: 8.25" L. X 4" W. X 2" H.

**RISER SETS (ACRYLIC)**  
SETS OF 4: 8" W. x 8" H., 7" W. x 6" H., 6" W. x 4" H., 5" W. x 2" H.

AC-33B BLACK FINISH, SETS OF 4  
AC-33C CLEAR FINISH, SETS OF 4

**DISPLAY RISERS (MIRROR FINISH 18/8 STAINLESS)**  
DURABLE AND STABLE SURFACE FOR DISPLAYING, NOT RECOMMENDED FOR PROLONGED USE WITH ACIDIC, CREAMY OR SALTY INGREDIENTS. HAND WASH RECOMMENDED.

RD-925 5 1/2" SQ., 6 5/8" SQ., 7 7/8" SQ., 9" SQ. 4-PIECE NESTING SET

**DISPLAY RISERS (ACRYLIC)**  
SCRATCH RESISTANT ACRYLIC MIRRORS, LIGHT WEIGHT AND DURABLE. HAND WASHING RECOMMENDED.  
SET OF FOUR, 8" SQ. x 8" HT., 7" SQ. x 6" HT., 6" SQ. x 4" HT., AND 5" SQ. x 2" HT.

AR-1598 BLACK FINISH  
AR-1599 CLEAR FINISH

**MIRACRYL™ DISPLAY CUBES (MIRROR FINISH ACRYLIC)**  
THEY ARE MADE OF A LIGHTWEIGHT, BREAK-RESISTANT ACRYLIC AND THE INNOVATIVE DESIGN ALLOWS THESE CUBE TO NEST INSIDE LARGER MIRACRYL CUBES. DISHWASHER SAFE AND FOR USE IN TEMPERATURES FROM 32° TO 160°F. BPA FREE.

AC-8000 8" L. X 8" W. X 7.75" H.  
AC-10000 9.75" L. x 9.75" W. x 9.62" H.  
AC-12000 11.75" L. x 11.75" W. x 11" H.

**ASHWOOD MARBLE RISERS (STAINLESS STEEL AND MARBLE MELAMINE)**  
CLEANING. DISHWASHER SAFE!

RS-1530 12" DIA. x 6" H.  
RS-1531 15" DIA. x 3.5" H.

**BLACK IRON STAND COLLECTION**  
THIS THREE TIER DISPLAY STAND HAS BEEN CREATIVELY CRAFTED OF DURABLE WROUGHT IRON AND WILL MAKE AN IMPRESSIVE DISPLAY! DESIGNED FOR ELEGANT FOOD PRESENTATIONS, BUFFET AND BANQUET TABLES, OR TO DRESS UP FAMILY-STYLE SERVICE.

WR-1500 3 TIER 9" ROUND BLACK IRON STAND, 27" H., 18" L., 14" W.  
WRB-1500 9" ROUND BLACK WIRE BASKET FOR WR-1500  
WRP-1500 11" DIA ROUND CERAMIC PLATE FOR WR-1500  
WR-1501 2 TIER 14" ROUND BLACK IRON STAND, 25" H., 20 1/2" L., 19" W.  
WRB-1501 14" ROUND BLACK WIRE BASKET FOR WR-1501  
WRP-1501 14" DIA ROUND CERAMIC BOWL FOR WR-1501  
WR-1502 2 TIER 13" SQUARE BLACK IRON STAND, 25" H., 20 1/2" L., 16 1/2" W.  
WRB-1502 13" SQUARE BLACK WIRE BASKET FOR WR-1502  
WRP-1502 14" SQ CERAMIC PLATTER FOR WR-1502

**RISER SETS (WROUGHT IRON OR STAINLESS STEEL)**  
5" X 3" X 6 1/2", 7" X 3" X 8 1/4", 7" X 9" X 9 1/2", 10" X 4" X 11 1/2", 12" X 6" X 14", 7" X 9" X 7"

AC-555 BLACK WROUGHT IRON RISER SETS, SET/6  
AC-556 STAINLESS STEEL RISER SETS, SET/6  
AC-557 SLIP STOP SLEEVES SET FOR AC-555 & AC-556, SET OF 3

# CAKE/DISPLAY STANDS

### 3 TIER DISPLAY STAND (STAINLESS)



TIERS ARE 12", 14" AND 16" DIAMETER, 24" HEIGHT.  
AC-73064



**3 TIER BUFFET STAND (HAMMERED FINISH STAINLESS)**  
MADE OF STAINLESS STEEL AND HAS A HAMMERED FINISH.  
AC-9855 18", 21", 23", 20" H.



**DISPLAY STAND (STAINLESS)**  
THIS STAINLESS STEEL STAND THAT HAS BEEN INDIVIDUALLY CRAFTED WITH A BALL PEEN HAMMER. NO TWO ARE ALIKE!  
ACSS-2319 23" DIA. x 20" H.



**DOUBLE WALL DISPLAY STAND (STAINLESS)**  
IDEAL FOR HOT AND COLD APPETIZERS & DESSERTS!  
CPS-72423 12" H. X 8.5" & 10.5" DIA



**3-TIER DESSERT STAND (SILVERPLATE)**  
PLATES NOT INCLUDED.  
AC-6869 HOLDS PLATES UP TO 9" DIA.

### REMINGTON 3 TIER DISPLAY STAND (18/8 STAINLESS)



TIERS ARE 8", 11" AND 14" DIAMETER, 17" HT. EAVY-DUTY.  
AC-2259

### 3 TIER STAND (STAINLESS) HAMMERED PLATES AND BEADED, CENTER SHAFT.



ACSS-8590  
19" H.,  
12" DIA.,  
10" DIA.,  
& 8" DIA.  
TRAYS

### 3 TIER TRAY STAND (STAINLESS) THE STAND COMES COMPLETE WITH THREE 9" DIA TRAYS.



TS-583  
15.7" H.,  
11.2" W.

### 3 TIER BEADED DISPLAY STAND (STAINLESS) A BEADED EDGE DESIGN AND A BEADED CENTER SHAFT.



AC-9865  
7.5" DIA.,  
10" DIA.,  
13" DIA.,  
18" H.

### BLACK IRON DESSERT STANDS PLATES NOT INCLUDED. STAND ONLY!



AC-1626 8" DIA., 18" HT.  
AC-1627 10" DIA., 20" HT.  
AC-1628 12" DIA., 25" HT.  
AC-1629 14" DIA., 30" HT.

### TIERED DISPLAY TRAY (STAINLESS) SQUARE



AC-72784 5.5", 5.5", & 7.5"  
AC-72784  
5.5" SQUARE,  
5.5" SQUARE,  
& 7.5" SQUARE



**3 TIER GALVANIZED DISPLAY STAND WITH GOLD BEADED EDGE TRAYS**  
THIS THREE TIER SERVING/DISPLAY TRAY IS GALVANIZED STEEL FOR A NATURAL FINISH.  
ACG-5400 16" X 21.5", PKG/4 EACH



**2 TIER BOWL GALVANIZED DISPLAY WITH ANTIQUE WOODEN HANDLE**  
THIS TWO TIER BOWL STAND IS GALVANIZED STEEL WITH AN ANTIQUED WOOD HANDLE FOR A NATURAL DESIGN.  
ACC-226 17" X 23.5", PKG/4 EACH



**SQUARE INTERLOCKING RISERS (ACRYLIC)**  
SHIPS KNOCKED DOWN. QUICK ASSEMBLY! 2 WEEK LEAD TIME.  
BK-9450 11" H. x 8.5" W. x 8.5" D.  
SHELF SIZES: 4", 5 5/8", 8.5"  
BETWEEN SHELVES: 2.5"  
BK-9451 16" H. x 11.5" W. x 11.5" D.  
SHELF SIZES: 5", 7", 9", 11.5"  
BETWEEN SHELVES: 3.75"  
BK-9452 21.75" H. x 15" W. x 15" D.  
SHELF SIZES: 6.25", 9", 12", 15"  
BETWEEN SHELVES: 5.25"  
BK-9453 27.5" H. x 18.5" W. x 18.5" D.  
SHELF SIZES: 7.75", 11.25", 15", 18.5"  
BETWEEN SHELVES: 6.5"  
BK-9454 34.25" H. x 22.75" W. x 22.75" D.  
SHELF SIZES: 10", 14.25", 18.5", 22.75"  
BETWEEN SHELVES: 8"

### STANDS (BLACK WROUGHT IRON) PLATTER NOT INCLUDED.

AC-7312 TWO TIER LARGE RECTANGULAR, 23 3/8" L. x 12 7/8" W. x 23 1/2" H., HOLDS CHI-7321 & CHI-7325  
AC-7313 THREE TIER LARGE RECTANGULAR, 24 1/2" L. x 12 9/16" W. x 32 3/8" H., HOLDS CHI-7321 & CHI-7325  
AC-7314 THREE TIER LARGE RECTANGULAR, 24" L. x 15 1/4" W. x 25 1/2" H., HOLDS CHI-7321 & 2 CHI-7325



### PLATTERS (CERAMIC)

CHI-7321 WHITE RECTANGULAR PLATTER, 21" x 13", FITS IN STAND AC-7312, AC-7313, OR AC-7314  
CHI-7323 WHITE RECTANGULAR PLATTER, 18" L. x 8 3/4" W., FITS AC-7314  
CHI-7325 WHITE WAVY PLATTER, 21" L. x 13.5" W., FITS AC-7312 & AC-7313



### BK-9954 EASILY FITS FOUR 12" CAKES ON THE BOTTOM TIER.



**ROUND INTERLOCKING RISERS (ACRYLIC)**  
SHIPS KNOCKED DOWN. QUICK ASSEMBLY! 2 WEEK LEAD TIME.  
BK-9950 11" H. x 10" DIA.  
SHELF DIAMETERS: 4", 6", 8", 10"  
SPACE BETWEEN SHELVES: 2.5"  
BK-9951 16" H. x 14" DIA.  
SHELF DIAMETERS: 5", 6", 11", 14"  
SPACE BETWEEN SHELVES: 3.75"  
BK-9952 21.75" H. x 19" DIA.  
SHELF DIAMETERS: 7", 11", 15", 19"  
SPACE BETWEEN SHELVES: 5.25"  
BK-9953 27.5" H. x 24" DIA.  
SHELF DIAMETERS: 9", 14", 19", 24"  
SPACE BETWEEN SHELVES: 6.5"  
BK-9954 34.25" H. x 30" DIA.  
SHELF DIAMETERS: 12", 18", 24", 30"  
SPACE BETWEEN SHELVES: 8"

# DISPLAY & SERVING TRAYS



### RUSTIC RISER/CRATE SET WITH CHALKBOARD FRONT (WOOD)

- INTEGRATED HANDLES
- THREE SIZE SET
- S: 15" X 10" X 7 7/8"
- M: 16 7/8" X 11 3/4" X 9 1/4"
- L: 16 1/2" X 11 3/4" X 7 1/2"

RR-101 WHITE DISTRESSED WOOD

RR-100 NATURAL WOOD



### CRATES COLLECTION TOWERS (18/10 STAINLESS STEEL WITH BLACK ACCENTED)

THE TOWERS CAN ALSO BE USED AS A DISPLAY OR RISERS.

- CRT-400 10.5" SQUARE X 4" TALL TOWER WITH GRILL & BURNER STAND
- CRT-401 10.5" SQUARE X 8" TALL TOWER WITH GRILL & BURNER STAND
- CRT-402 10.5" SQUARE X 12" TALL TOWER WITH GRILL & BURNER STAND
- CRT-410 TOWER STAND GRILL PLATE ONLY
- CRT-411 TOWER STAND BURNER STAND ONLY
- CRT-420 CONDIMENT CADDY WITH 6 DIVIDER INSERT 9.13" X 5.13" X 3.38" H
- CRT-421 6 DIVIDER INSERT ONLY FOR CONDIMENT CADDY
- CRT-422 9" X 6.5" SMALL BREAD BASKET
- CRT-423 14" X 8" MEDIUM BREAD BASKET
- CRT-424 20" X 12" LARGE BREAD BASKET
- CRT-425 BREAD & BAGUETTE BASKET SET, 10.63" X 8.13" X 2.63" H
- CRT-426 BAGUETTE BASKET ONLY FOR BREAD & BAGUETTE SET
- CRT-427 FLATWARE HOLDER WITH 4 DIVIDER INSERT, 6.25" SQUARE X 4.75" H
- CRT-428 4 DIVIDER INSERT ONLY FOR FLATWARE HOLDER



### ACACIA SERVING BOARDS/PLATTERS (MELAMINE)

THESE BOARDS LOOK LIKE SOLID WOOD. BUT THEY ARE BREAK RESISTANT MELAMINE. THEY ARE DURABLE, WASHABLE, AND STAIN RESISTANT. SOLD IN CASE PACKS OF 2 ONLY.

- |         |                                     |         |
|---------|-------------------------------------|---------|
| WB-7700 | 17 3/8" L. x 9 7/8" W. x 5/8" H.    | ORGANIC |
| WB-7701 | 13 1/2" DIA. x 1/4" H.              | ROUND   |
| WB-7702 | 25 1/2" L. x 10 1/2" W. x 1 1/4" H. | OVAL    |
| WB-7703 | 21 1/2" DIA. x 1/4" H.              | ROUND   |



### FAUX OLIVE WOOD SERVING BOARDS (MELAMINE)

THESE BOARDS LOOK LIKE SOLID WOOD YET ARE DURABLE, DISHWASHER SAFE AND STAIN RESISTANT. SOLD IN CASE PACKS OF 2.

- |         |                                     |         |
|---------|-------------------------------------|---------|
| WB-7500 | 17 3/8" L. x 9 7/8" W. x 5/8" H.    | ORGANIC |
| WB-7501 | 13 3/4" DIA. x 1/4" H.              | ROUND   |
| WB-7502 | 25 1/2" L. x 10 1/4" W. x 1 1/4" H. | OVAL    |
| WB-7503 | 21 3/4" DIA. x 1/4" H.              | ROUND   |



### WOOD CRATES

THIS CRATE IS A GREAT WAY TO DO THAT. IT COMES IN TWO OPTIONS, NATURAL ACACIA WOOD OR BLACK PAINTED WOOD. CAN BE USED FOR STORAGE, DISPLAY, OR EVEN A RISER. 12 3/4" X 6 7/8" X 6 1/4"

- |         |                    |
|---------|--------------------|
| CRT-500 | ACACIA WOOD        |
| CRT-501 | BLACK PAINTED WOOD |



### FAUX MATTE GRANITE DISPLAY PLATTER (MELAMINE)

100% BPA FREE AND BREAK-RESISTANT. THEY ARE DISHWASHER SAFE. SOLD IN CASE PACKS OF 6 EACH.

- |            |          |                     |
|------------|----------|---------------------|
| CHI-1473BK | 14" x 7" | CASE PACK<br>6 EACH |
|------------|----------|---------------------|



### SERVING BOARDS & RISERS (MELAMINE)

THESE SERVING BOARDS AND RISERS ARE MADE OF DURABLE MELAMINE, BUT HAVE THE LOOK OF RECLAIMED WOOD. THERE ARE MANY SIZES TO CHOOSE FROM TO MAKE YOUR NEXT EVENT A SUCCESS. SOLD BY THE CASE PACKS OF 3 ONLY.

- |         |  |
|---------|--|
| WB-1470 | SERVING BOARD, RECTANGULAR, 14 1/4" L. X 8" W. X 3/8" H.         |
| WB-1471 | SERVING BOARD, RECTANGULAR, 17 3/4" L. X 8 3/4" W. X 3/8" H.     |
| WB-1472 | SERVING BOARD, ORGANIC ROUND, 16 3/8" L. X 14 5/8" W. X 5/8" H.  |
| WB-1473 | SERVING BOARD, RECTANGULAR, 21 3/8" L. X 12 3/4" W. X 3/8" H.    |
| WB-1474 | SERVING BOARD, ORGANIC OBLONG, 21 1/4" L. X 10 5/8" W. X 5/8" H. |
| WB-1475 | RISER, ROUND, 10 1/8" DIA X 2 1/5" H                             |
| WB-1476 | RISER, RECTANGULAR, 12 1/4" L. X 6 3/4" W. X 2" H.               |



### MELAMINE FAUX SLATE PLATTERS AND BOWLS

THESE PLATTERS ARE MADE FROM NEARLY INDESTRUCTIBLE MELAMINE FOR LONG LASTING RELIABILITY ON EVERYDAY USAGE. NOT RECOMMENDED FOR MICROWAVE USE. SOLD IN CASE PACKS ONLY!

- |         |                                  |         |                     |
|---------|----------------------------------|---------|---------------------|
| FSP-101 | 14 3/4" L. X 8 1/4" W. X 1/4" H. | PLATTER | CASE PACK<br>6 EACH |
| FSP-102 | 18" L. X 8 1/2" W. X 1/4" H.     | PLATTER | 6 EACH              |
| FSP-103 | 14 1/2" SQ. X 1/4" H             | PLATTER | 3 EACH              |
| FSP-104 | 21 1/2" L. X 13" W. X 1/4" H.    | PLATTER | 3 EACH              |
| FSB-101 | 5" SQ. X 2 7/8" H., 23 OZ.       | BOWL    | 6 EACH              |
| FSB-102 | 7" SQ. X 3 1/4" H., 58 OZ.       | BOWL    | 6 EACH              |
| FSB-103 | 9 1/2" SQ. X 4" H., 125 OZ.      | BOWL    | 6 EACH              |
| FSB-104 | 12" SQ. X 4 1/2" H., 208 OZ.     | BOWL    | 3 EACH              |



### SLATE BOARD CHALK BOARD COLLECTION

THIS GENUINE SLATE BOARD HAS TEXTURED EDGES AND PADDED FEET. USE CHALK TO WRITE ON THE BOARD TO LABEL THE FOOD OR WRITE A SPECIAL MESSAGE TO YOUR GUESTS. THE CHALK WILL WIPE CLEAN WITH A DAMP CLOTH. GREY COLOR. SOLD IN CASE PACKS OF 6 EACH.

- |         |              |                     |
|---------|--------------|---------------------|
| SL-2400 | 6" X 12"     | CASE PACK<br>6 EACH |
| SL-2401 | 12" X 15.75" | 6 EACH              |



### SLATE DISPLAY TRAYS

THESE DISPLAY TRAYS ARE MADE FROM NATURAL REAL SLATE. SOLD IN CASES OF SIX ONLY.

- |          |  |
|----------|--|
| SLT-1500 | 4.9" X 10" RECTANGULAR SLATE TRAY                      |
| SLT-1501 | 7.8" X 11.5" RECTANGULAR SLATE TRAY                    |
| SLT-1502 | 7.8" X 11.5" RECTANGULAR SLATE TRAY WITH TUBE HANDLES  |
| SLT-1503 | 9.8" X 13.7" RECTANGULAR SLATE TRAY WITH TUBE HANDLES  |
| SLT-1504 | 9.8" X 13.7" RECTANGULAR SLATE TRAY WITH CHILI HANDLES |
| SLT-1505 | 9.8" X 15.6" RECTANGULAR SLATE TRAY                    |
| SLT-1506 | 9.8" X 15.6" RECTANGULAR SLATE TRAY WITH TUBE HANDLES  |
| SLT-1507 | 8.2" X 16.4" RECTANGULAR SLATE TRAY WITH TUBE HANDLES  |
| SLT-1508 | 8.2" X 16.4" RECTANGULAR SLATE TRAY WITH CHILI HANDLES |
| SLT-1509 | 9.8" X 19.5" RECTANGULAR SLATE TRAY WITH TUBE HANDLES  |
| SLT-1510 | 9.8" X 19.5" RECTANGULAR SLATE TRAY WITH CHILI HANDLES |
| SLT-1511 | 4.3" X 7.8" RECTANGULAR SLATE TRAY                     |
| SLT-1512 | 5.5" X 9.1" RECTANGULAR SLATE TRAY                     |
| SLT-1513 | 7.9" X 14.6" RECT CERAMIC TRAY WITH SLATE INSERT       |
| SLT-1514 | 11.7" SQUARE SLATE TRAY                                |
| SLT-1515 | 7.8" SQUARE SLATE TRAY                                 |
| SLT-1516 | 9.6" SQUARE SLATE TRAY                                 |



### WALNUT SERVING BOARDS (MELAMINE)

THE LOOK OF SOLID WOOD IN MELAMINE, THEY ARE DURABLE, WASHABLE, AND STAIN RESISTANT. GREAT ADDITION TO ANY DISPLAY! SOLD IN CASE PACKS ONLY!

- |         |  |                     |
|---------|--|---------------------|
| WB-7600 | 11 1/4" SQ. x 3/8" H., SQUARE                  | CASE PACK<br>6 EACH |
| WB-7601 | 20 7/8" L. x 12 1/2" W. x 3/8" H., RECTANGULAR | 3 EACH              |



### ELM WOOD SERVING BOARDS/PLATTERS (MELAMINE)

MELAMINE ELM WOOD DISPLAY AND SERVING BOARDS. THEY ARE DURABLE, WASHABLE, AND STAIN RESISTANT. GREAT ADDITION TO ANY ELEGANT DISPLAY! SOLD IN CASE PACKS ONLY!

- |         |  |                     |
|---------|--|---------------------|
| WB-7800 | 11 1/4" SQ. x 3/8" H., SQUARE                  | CASE PACK<br>6 EACH |
| WB-7801 | 20 7/8" L. x 12 1/2" W. x 3/8" H., RECTANGULAR | 3 EACH              |



### FAUX WALNUT PLATTERS (MELAMINE)

PLATTERS ARE DURABLE, DISHWASHER SAFE, AND STAIN RESISTANT. BUFFETS, AND PRESENTATIONS! THE LOOK OF WALNUT WITH THE DURABILITY OF MELAMINE.

- |         |                                    |
|---------|------------------------------------|
| WB-7900 | 14 1/4" L. x 7 1/2" W. x 1 1/2" H. |
| WB-7901 | 18" L. x 8 1/4" W. x 2" H.         |
| WB-7902 | 21" L. x 13" W. x 2" H.            |

# DISPLAY & SERVING TRAYS



### FAUX SLATE BLACK MELAMINE DISPLAY PLATTERS

100% BPA FREE AND BREAK-RESISTANT. THEY ARE DISHWASHER SAFE. YOU CAN EVEN LABEL WITH CHALK FOR EASY IDENTIFICATION OR TO ADD A UNIQUE PRESENTATION TO YOUR EVENT. SOLD IN CASE PACKS.

Item	Size	Case Pack
CHI-1111BK	11" x 11"	6 EACH
CHI-1350BK	12.75" x 5"	6 EACH
CHI-1470BK	14" x 7"	6 EACH



### FAUX SLATE BLACK SEMI-GLOSS MELAMINE DISPLAY PLATTERS

100% BPA FREE AND BREAK-RESISTANT. THEY ARE DISHWASHER SAFE. LABEL WITH CHALK FOR EASY IDENTIFICATION OR TO ADD A UNIQUE PRESENTATION TO YOUR EVENT. SOLD IN CASE PACKS.

Item	Size	Case Pack
CHI-1011BK	10" x 10"	6 EACH
CHI-1471BK	14" x 7"	6 EACH



### WHITE SHADOW MELAMINE SERVING BOARDS

THEY ARE LIGHT BUT DURABLE WHICH MAKES THEM GREAT FOR ANY EVENT.

Item	Size	Case Pack
MB-5590	14 3/4" X 8 1/4" W/O HANDLE	6 EACH
MB-5591	20 3/4" X 6 1/4" W/O HANDLE	6 EACH
MB-5592	8 1/2" X 7" W/HANDLE	6 EACH
MB-5593	12 1/2" X 5 1/2" W/HANDLE	6 EACH

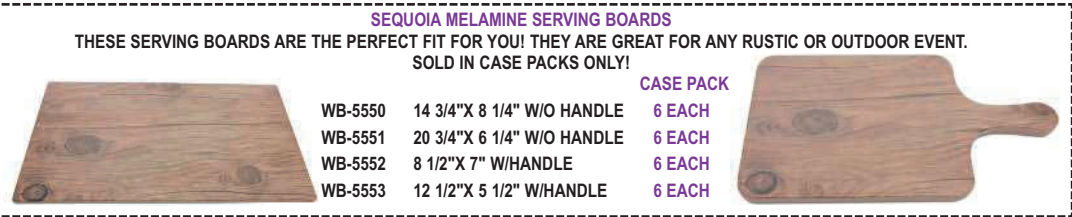

### SEQUIOIA MELAMINE SERVING BOARDS

THESE SERVING BOARDS ARE THE PERFECT FIT FOR YOU! THEY ARE GREAT FOR ANY RUSTIC OR OUTDOOR EVENT. SOLD IN CASE PACKS ONLY!

Item	Size	Case Pack
WB-5550	14 3/4" X 8 1/4" W/O HANDLE	6 EACH
WB-5551	20 3/4" X 6 1/4" W/O HANDLE	6 EACH
WB-5552	8 1/2" X 7" W/HANDLE	6 EACH
WB-5553	12 1/2" X 5 1/2" W/HANDLE	6 EACH



### FAUX OAK WOOD MELAMINE DISPLAY PLATTERS

100% BPA FREE AND BREAK-RESISTANT. THEY ARE DISHWASHER SAFE. SOLD IN CASE PACKS.

Item	Size	Case Pack
CHI-1010OW	10" x 10"	6 EACH
CHI-1210OW	12" x 10"	6 EACH
CHI-2010OW	20" x 10"	3 EACH
CHI-1472OW	14" x 7"	6 EACH



### ONYX MELAMINE SERVING BOARDS

THESE SERVING BOARDS ARE MUCH LIGHTER THAN ACTUAL GRANITE.

Item	Size	Case Pack
SB-5580	14 3/4" X 8 1/4" W/O HANDLE	6 EACH
SB-5581	20 3/4" X 6 1/4" W/O HANDLE	6 EACH
SB-5582	8 1/2" X 7" W/HANDLE	6 EACH
SB-5583	12 1/2" X 5 1/2" W/HANDLE	6 EACH



### WOOD SERVING BOARDS (SOLID WOOD)

Item	Size
WSB-200	18" L. x 4.25" W. x 0.5" H.
WSB-300	18" L. x 6.5" W. x 0.5" H.
WSB-400	18" L. x 8" W. x 0.5" H.



### RECTANGULAR WOOD CHEESEBOARD WITH 3 STAINLESS CHEESE UTENSILS

THE WOOD BOARD IS 10.625" X 7.75" X 2" H. AND HOLDS THE 3 CHEESE TOOLS INSIDE. EACH TOOL IS BETWEEN 7" AND 8.5" LONG AND MADE FROM STAINLESS STEEL.

CS-1582 BOARD: 10.625" X 7.75" X 2" H.



### WOOD BOARD WITH ULU KNIFE

THIS 9.5" ROUND WOOD BOARD COMES WITH A MATCHING ULU KNIFE THAT HAS A WOOD HANDLE. THE BOARD HAS A ROUNDED RECESS THAT MATCHES THE CURVATURE OF THE ULU KNIFE BLADE. THE ULU KNIFE IS EFFECTIVE AT CUTTING, CHOPPING, AND MINCING BECAUSE OF ITS CURVED BLADE THAT PLACES PRESSURE DIRECTLY OVER THE BLADE RATHER THAN THE END OF A TRADITIONAL KNIFE. THE ULU KNIFE IS 5.5" WIDE AND 4.25" TALL.

CB-15803 9.5" L. BOARD



### ROUND WOOD CHEESEBOARD WITH 4 STAINLESS CHEESE UTENSILS

THE WOOD BOARD HOLDS THE 4 CHEESE TOOLS INSIDE. EACH TOOLS IS MADE FROM STAINLESS STEEL.

CS-1583



### NATURAL WOOD SLICE TRAY

THIS TRAY IS A GREAT RUSTIC DISPLAY OPTION FOR PRESENTATIONS. IT IS MADE FROM NATURAL WOOD AND IS FOOD SAFE. IT IS DOUBLE SIDED WITH ONE SIDE FLAT AND THE OTHER INDENTED. HAND WASH WITH MILD DETERGENT AND WIPE WITH A DRY CLOTH.

AT-3556 17" DIA. X 1 1/2" H.



### BOTTLE SHAPED RUBBER WOOD CHEESE BOARD WITH 3 UTENSILS

SLIDE THE TOP AND INSIDE ARE A CHEESE KNIFE, CHEESE FORK, AND A CORK SCREW. THE BOARD MEASURES 13" X 4.75" AND IS MADE FROM SOLID RUBBER WOOD. THE TOOLS ARE STAINLESS STEEL WITH RUBBER WOOD HANDLES.

CB-15800 13" x 4.75" BOARD



### RUBBER WOOD BOARD WITH CHEESE DOME & 3 UTENSILS

THIS SET INCLUDES A 14.25" LENGTH RUBBER WOOD BOARD, A CLEAR GLASS DOME, AND THREE STAINLESS STEEL AND RUBBER WOOD HANDLED UTENSILS FOR THE PERFECT CHEESE DISPLAY. THE BOARD HAS A FLAT SIDE AND THE REVERSE HAS A RECESSED AREA FOR THE GLASS DOME AND UTENSILS.

CB-15802 14" L. BOARD



### RUBBER WOOD PIZZA BOARD WITH 2 UTENSILS

THIS 14" DIAMETER WOOD CHEESE BOARD IS MADE FROM RUBBER WOOD. THE MATCHING TOOLS WILL MAKE YOUR EVENT A HIT! THE BOARD HAS A SMOOTH SIDE AND A SIDE WITH ROUTED GUIDES FOR SLICING. BOTH UTENSILS, ROTARY WHEEL SLICER AND SLICE LIFTER, ARE STAINLESS STEEL WITH RUBBER WOOD HANDLES.

CB-15801 14" L. BOARD



### 5 PC ROUND SERVING SET WITH 4 DISHES AND WOOD BOARD

THIS SERVING SET COMES COMPLETE WITH 4 TRIANGULAR SHAPED BOWLS AND A 9.5" DIA. WOOD BASE. EACH BOWL HOLDS 3 OUNCES. THE BOWLS FIT TOGETHER TO MAKE A CIRCLE THAT FITS SECURELY IN THE WOOD BASE.

SS-0154 9.5" DIA.



### TRAY WITH BUILT IN SAUCE CUPS (PORCELAIN)

WHITE PORCELAIN TRAY WITH BUILT-IN SAUCE CUPS. PERFECT FOR SERVING APPETIZERS AND DESSERTS, THIS PORCELAIN TRAY WAS MADE FOR FOODS THAT NEED DIPPING OR SAUCES.

Item	Size	Color
CHI-136	13" L. x 6" W.	WHITE
CHI-140	13" L. x 9 1/3" W.	WHITE



### PLATTERS (PORCELAIN)

THREE SECTION PORCELAIN PLATTER. A BEAUTIFUL WAY TO DISPLAY ASSORTED DESSERTS AND APPETIZERS AT BUFFETS! THIS IS ALSO A GREAT WAY TO SHOWCASE DESSERT CART ITEMS.

CHI-1783 17" L. x 7.75" W., WHITE

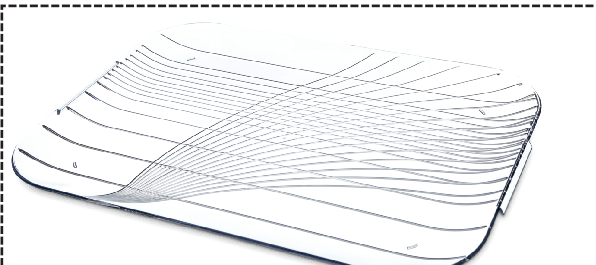

### FESTIVAL TRAY™ (ACRYLIC)

MOLDED-IN PATTERN GIVES THE APPEARANCE OF FINE ETCHED CRYSTAL. ECONOMICAL, BREAK-RESISTANT SAN RESISTS FOOD ACIDS AND OILS. SAFE IN TEMPERATURES FROM 0° TO 180°F; DISHWASHER SAFE. SAN IS RESISTANT TO STAINING, BREAKING AND CHIPPING. MADE IN USA

Item	Size
TR-1602	12.5"x7"
TR-1603	15"x10.75"
TR-1604	22"x16" WITH HANDLES
TR-1605	13"x19.5" WITH HANDLES



### CURVED END RECTANGULAR PLATTERS (PORCELAIN)

THIS RECTANGULAR PLATTER IS MADE OF WHITE PORCELAIN AND FEATURES CURVED ENDS.

Item	Size	Color	Case Pack
CHI-13911	11.5" x 4"	WHITE	4 EACH
CHI-13913	13.5" x 4.5"	WHITE	4 EACH
CHI-13915	15.5" x 5"	WHITE	4 EACH

# TRAYS

## SERVING TRAYS (18/8 STAINLESS)

HEAVY GAUGE, HIGHLY RESISTANT TO CORROSION, PITTING, AND RUSTING. SATIN FINISHED RIM AND MIRROR FINISHED INTERIOR, DISHWASHER SAFE.

- TR-8200 11.75" SQUARE
- TR-8201 15.75" SQUARE
- TR-8202 18.5" SQUARE
- TR-8203 12" x 9" RECTANGULAR
- TR-8204 10" x 18" RECTANGULAR
- TR-8205 12" x 21" RECTANGULAR
- TR-8206 12" DIA. ROUND
- TR-8207 14" DIA. ROUND
- TR-8208 16" DIA. ROUND
- TR-8209 14.75" L., 10 7/8" W., OVAL
- TR-8212 17 5/8" L., 13" W., OVAL
- TR-8213 21 1/8" L., 15.5" W., OVAL



## HAMMERED OVAL TRAYS (18/8 STAINLESS STEEL)

INDIVIDUALLY CRAFTED WITH A BALL-PEEN HAMMER, HEAVY DUTY, DISHWASHER SAFE.

- TR-247 23.75" L. x 7.5" W., RECTANGULAR
- TR-248 16" L. x 11" W., RECTANGULAR
- TR-426 11" W. x 15" L. x 7/8" DEEP, OVAL
- TR-427 13.25" W. x 17.25" L. x 7/8" DEEP, OVAL
- TR-428 15.5" W. x 20" L., OVAL
- TR-430 16" SQUARE x 1 1/2" DEEP
- TR-431 18" SQUARE x 1 1/2" DEEP
- TR-432 20" SQUARE x 1 1/2" DEEP
- TR-433 22" SQUARE x 1 1/2" DEEP
- TR-435 18" DIA. x 1" DEEP, ROUND
- TR-436 20" DIA. x 1" DEEP, ROUND
- TR-437 22" DIA. x 1" DEEP, ROUND
- TR-438 13.5" DIA. x 1" DEEP, ROUND



## TRAYS (CHROMEPLATE)

EMBOSSED CENTER, ROLLED EDGE. SOLD IN CASE PACKS OF 6

- |        |                 |             |        |
|--------|-----------------|-------------|--------|
| TR-766 | 9 1/2" x 6 3/4" | OVAL        | 6 EACH |
| TR-767 | 12" x 8"        | OVAL        | 6 EACH |
| TR-768 | 15" x 10"       | OVAL        | 6 EACH |
| TR-769 | 18" x 13"       | OVAL        | 6 EACH |
| TR-770 | 10" DIA.        | ROUND       | 6 EACH |
| TR-771 | 12" DIA.        | ROUND       | 6 EACH |
| TR-772 | 14" DIA.        | ROUND       | 6 EACH |
| TR-773 | 16" x 12"       | RECTANGULAR | 6 EACH |



## OBLONG SERVING AND DISPLAY TRAYS (STAINLESS STEEL)

SATIN FINISHED STAINLESS STEEL, HEAVY DUTY CONSTRUCTION. SMOOTH ROUNDED CORNERS AND SEAMLESS CONSTRUCTION.

- |          |                          |        |
|----------|--------------------------|--------|
| TR-80130 | 13 5/8" x 9 3/4" x 5/8"  | OBLONG |
| TR-80150 | 15 1/8" x 10 1/2" x 5/8" | OBLONG |
| TR-80170 | 17 1/8" x 11 5/8" x 5/8" | OBLONG |
| TR-80190 | 19" x 12 1/2" x 5/8"     | OBLONG |



## HAMMERED TRAYS (STAINLESS)

- |         |               |             |
|---------|---------------|-------------|
| TR-7460 | 13.75" x 4.5" | RECTANGULAR |
| TR-7461 | 17.75" x 5.5" | RECTANGULAR |
| TR-7462 | 25.5" x 5.5"  | RECTANGULAR |



## DOUBLE WALL CURVED TRAYS (STAINLESS STEEL)

HAMMERED FINISH CURVED TRAYS. TRAYS KEEP COLD FOODS COLD AND HOT FOODS HOT.

- |          |             |             |
|----------|-------------|-------------|
| TR-72609 | 15" x 8.25" | RECTANGULAR |
| TR-72647 | 12"         | TRIANGULAR  |



## TRAYS (CHROMEPLATE)

EMBOSSED CENTER, ROLLED EDGE.

- |         |                   |                     |
|---------|-------------------|---------------------|
| TR-1223 | 18" x 12 1/2"     | OBLONG              |
| TR-1224 | 20" x 14"         | OBLONG              |
| TR-1225 | 17" x 12 1/2"     | OCTAGONAL           |
| TR-1226 | 20" x 14"         | OCTAGONAL           |
| TR-1230 | 19 1/2" x 12 1/2" | OBLONG WITH HANDLES |



## ESQUIRE TRAYS (18/8 STAINLESS)

HEAVY DUTY MIRROR FINISH WITH EMBOSSED CENTER, AND DECORATIVE EDGE.

- |         |                   |             |
|---------|-------------------|-------------|
| TR-1146 | 12.5" x 18.5"     | RECTANGULAR |
| TR-1147 | 14.25" x 21"      | RECTANGULAR |
| TR-1149 | 14" DIA.          | ROUND       |
| TR-1150 | 16" DIA.          | ROUND       |
| TR-1151 | 10 7/8" x 14 3/4" | OVAL        |
| TR-1152 | 13" x 17 5/8"     | OVAL        |
| TR-1153 | 15 1/2" x 21 1/8" | OVAL        |



## TRAY WITH HANDLES (18/10 STAINLESS)

- |          |              |      |
|----------|--------------|------|
| TR-73072 | 16.25" x 14" | OVAL |
|----------|--------------|------|



## SOPRANO TRAYS (18/8 STAINLESS)

- |         |               |                 |
|---------|---------------|-----------------|
| TR-3411 | 12" X 10"     | WITHOUT HANDLES |
| TR-3412 | 15" X 11"     | WITHOUT HANDLES |
| TR-3413 | 20" X 14"     | WITHOUT HANDLES |
| TR-3414 | 20" X 14"     | WITH HANDLES    |
| TR-3415 | 22" X 17"     | WITHOUT HANDLES |
| TR-3416 | 24" X 18 1/2" | WITHOUT HANDLES |
| TR-3417 | 30" X 20"     | WITHOUT HANDLES |

## GOLD ALUMINUM MAPLE LEAF PLATTER

IT IS A SMALLER SIZE FOR CANDY, FRUIT, APPETIZERS, OR EVEN CONDIMENTS.

- |          |         |
|----------|---------|
| LP-72600 | 9" X 7" |
|----------|---------|





# TRAYS



**TRAYS (STAINLESS)**  
GADROON BORDER, EMBOSSED CENTER, BRIGHT FINISH. HEAVY WEIGHT.

TR-11232	12" DIA.	ROUND
TR-11233	14" DIA.	ROUND
TR-11234	16" DIA.	ROUND
TR-11235	18" DIA.	ROUND



**SERVING TRAYS (STAINLESS)**  
ECONOMY. SOLD IN CASE PACKS OF 6.

TRSS-300	12" DIA.	ROUND
TRSS-301	14" DIA.	ROUND
TRSS-302	16" DIA.	ROUND
TRSS-305	9" x 14"	OVAL
TRSS-306	11" x 16"	OVAL
TRSS-307	12" x 19"	OVAL
TRSS-308	14" x 21"	OVAL



**ROLLED EDGE OVAL TRAYS (18/10 STAINLESS)**

TRSS-1200	12 3/16" X 8 11/16"
TRSS-1400	14 1/8" X 10 3/16"
TRSS-1600	16 5/16" X 11 3/16"
TRSS-1800	18 1/8" X 13 3/16"
TRSS-2000	20 1/16" X 14 11/16"



**GADROON TRAYS (SILVERPLATE)**  
HEAVY WEIGHT TRAY. PLAIN CENTER.

TR-3008	8" DIA.	ROUND
TR-3010	10" DIA.	ROUND
TR-3012	12" DIA.	ROUND



**TRAYS (18/8 STAINLESS)**  
MIRROR FINISH. EMBOSSED CENTER.

TR-591	12 3/8"	ROUND
TR-592	15 1/4"	ROUND
TR-593	18 5/8"	ROUND



**GADROON EDGE WITH EMBOSSED CENTER TRAY (SILVERPLATE)**  
EACH TRAY HAS AN EMBOSSED CENTER WITH A PLAIN, ENGRAVABLE CENTER.

TR-310	10" DIA.	ROUND
TR-312	12" DIA.	ROUND
TR-314	14" DIA.	ROUND



**OBLONG TRAY (SILVERPLATE)**

TRAY WITH FEET. EMBOSSED CENTER!  
TR-58 23" x 14"



**OBLONG TRAY (SILVERPLATE)**

TRAY WITH FEET. EMBOSSED CENTER!

TR-733  
23" x 14"



**GADROON TRAYS (SILVERPLATE)**  
EMBOSSED CENTER.

TR-208	8" DIA.	ROUND
TR-210	10" DIA.	ROUND
TR-212	12" DIA.	ROUND
TR-216	16" DIA.	ROUND
TR-220	20" DIA.	ROUND



**CIRCLE CENTER TRAYS WITH WIDE RIM (STAINLESS STEEL)**

TRS-3600	10" DIA.	ROUND
TRS-3601	12" DIA.	ROUND
TRS-3602	14" DIA.	ROUND
TRS-3603	16" DIA.	ROUND
TRS-3600	18" DIA.	ROUND



**APPETIZER TRAY (18/0 STAINLESS)**  
FEATURES A SATIN PEWTER FINISH, DISHWASHER SAFE, SAFE FOR DIRECT FOOD CONTACT.

TR-5896 6" DIA. ROUND

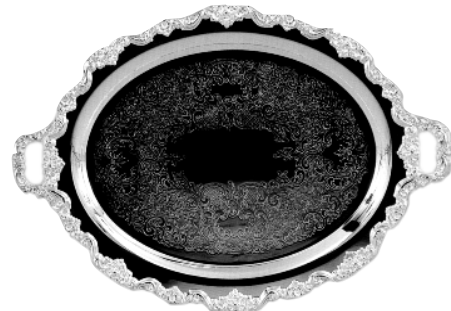

**APPLIED BORDER TRAY WITH HANDLES (SILVERPLATE)**

ROMANTICA EMBOSSED CENTER TRAY. HEAVY DUTY. ORNATE AND ELEGANT.

TR-791  
17" DIA. ROUND

**HAMMERED OVAL TRAYS (STAINLESS)**  
THESE SERVING TRAYS ARE MADE FROM HAMMERED STAINLESS STEEL AND ARE IDEAL FOR SERVING, PRODUCT DISPLAY, BUFFET PROPS, HIGH PROFILE THEMES OR JUST GENERAL USE.



TR-7230	15" X 11.25" X 1" H.
TR-7231	18" X 13.25" X 1" H.



**ONEIDA NOBLESSE TRAYS (18/10 STAINLESS)**  
EXTRA HEAVY. PLAIN CENTER.

TR-3522	24" DIA.	OVAL TRAY
TR-3509	12" DIA.	ROUND TRAY
TR-3510	14" DIA.	ROUND TRAY
TR-3512	16" DIA.	ROUND TRAY
TR-3513	18" DIA.	ROUND TRAY



**VOGUE TRAYS (SILVERPLATE)**

THEY ARE PLAIN, SIMPLE, WITH MINIMALISTIC LINES. HAND WASH ONLY AND THEY COME COMPLETE WITH A GIFT BOX.

TR-22390	8" DIA.	ROUND
TR-22391	10" DIA.	ROUND
TR-22392	12" DIA.	ROUND
TR-22393	14" DIA.	ROUND



**GALLERY TRAY (SILVERPLATE)**

EMBOSSED CENTER DESIGN.  
TR-1302 12.75" DIA. ROUND



**HAMMERED TRAYS (STAINLESS)**

TRH-260	13" DIA.	ROUND
TRH-261	16" DIA.	ROUND



**TRAY (18/10 STAINLESS)**  
PLAIN CENTER. DISHWASHER SAFE!

TR-6193	22" x 13"	OVAL
TR-6194	14" DIA.	ROUND
TR-6195	14" x 11"	RECTANGULAR



**TRAYS (STAINLESS)**  
CIRCULAR CENTER.

TRS-6501	10" DIA.	1" HIGH EDGE
TRS-6502	12" DIA.	1" HIGH EDGE
TRS-6503	14" DIA.	1" HIGH EDGE
TRS-6504	16" DIA.	1" HIGH EDGE
TRS-6505	18" DIA.	1" HIGH EDGE
TRS-6506	20" DIA.	1" HIGH EDGE
TRS-6507	22" DIA.	1" HIGH EDGE

**BRICK TRAY (STAINLESS STEEL)**  
A UNIQUE BRICK PATTERN.  
TR-7301 12" SQUARE

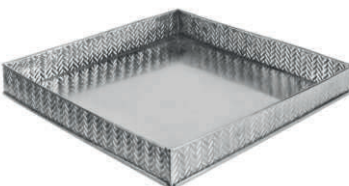

**NIKKO PLATTERS (STAINLESS)**  
THESE NIKKO PLATTERS FEATURE A QUALITY STAINLESS STEEL CONSTRUCTION.



PLT-8520	20" x 6"	RECTANGULAR
PLT-8521	15.5" x 5"	RECTANGULAR
PLT-8522	11.5" x 4"	RECTANGULAR



**CHIPPENDALE TRAYS (STAINLESS STEEL)**  
TRADITIONAL CHIPPENDALE RIBBON DESIGN.

TR-8950	5" DIA.	ROUND
TR-8951	7" DIA.	ROUND
TR-8952	8.5" DIA.	ROUND
TR-8953	10" DIA.	ROUND
TR-8954	12" DIA.	ROUND
TR-8955	14" DIA.	ROUND

# TRAYS



**HAMMERED SUSHI TRAYS (STAINLESS STEEL)**

THEY FEATURE A HAMMERED DESIGN. FOR YOUR NEXT SUSHI PRESENTATION, TRY THESE SLEEK SUSHI TRAYS.

TR-HMST10	10" L. x 4.5" W. x 1/2" H.
TR-HMST20	20" L. x 4.5" W. x 1/2" H.



**OBLONG GADROON TRAYS (18/8 STAINLESS)**  
MIRROR FINISH, EMBOSSED CENTER. DISHWASHER SAFE.

TR-587	17 7/8" x 13 7/8"
TR-588	23 1/2" x 18 1/2"



**TRAYS (SILVERPLATE)**  
HEAVY DUTY, OG EDGE, PLAIN CENTER.

TR-2770	20" DIA.	ROUND
TR-2771	17" DIA.	ROUND
TR-2772	14.5" DIA.	ROUND
TR-2773	12" DIA.	ROUND
TR-2775	8" DIA.	ROUND



**TRAY (18/8 STAINLESS)**

THIS TRAY IS MADE OF 18/8 STAINLESS STEEL. BEAUTIFULLY CRAFTED WITH A LATTICE DESIGN AROUND THE EDGE.

TR-9800	15" DIA. ROUND
---------	----------------



**SIMON TRAYS (NICKELPLATE)**

THEY ARE PLAIN WITH A SIMPLE THREAD BORDER. GREAT FOR ENGRAVING AS WELL.

TR-22380	8" DIA.	ROUND
TR-22381	10" DIA.	ROUND
TR-22382	12" DIA.	ROUND



**SERVING TRAYS (STAINLESS)**

THESE STAINLESS STEEL TRAYS HAVE A RAISED LIP.

TRSS-4800	14" DIA. ROUND HAMMERED EDGE
TRSS-4801	14" DIA. ROUND MIRROR EDGE



**SQUARE TRAYS (STAINLESS)**

TR-6142	11" x 11" x 7/8" H.	SQUARE
TR-6143	13" x 13" x 7/8" H.	SQUARE
TR-6144	15" x 15" x 7/8" H.	SQUARE



**TRAYS (SILVERPLATE)**

TR-279	16" x 16" SQUARE
--------	------------------



**PLAIN OVAL TRAY (NICKELPLATE)**

HAND WASH ONLY. COMES COMPLETE WITH A GIFT BOX.

TR-22147	6" x 4"
----------	---------



**SERPENTINE GALLERY TRAY (SILVERPLATE)**

SERPENTINE STYLE SILVERPLATE GALLERY TRAY. EMBOSSED CENTER.

TR-8926	11" x 15"
---------	-----------

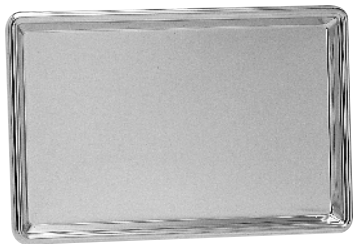

**TRAYS (NICKELPLATE)**

PLAIN CENTER, OG EDGE DESIGN.

TR-1129	6" x 9" RECTANGULAR
TR-1130	8" x 12" RECTANGULAR



**TRAY (18/10 STAINLESS)**

PLAIN CENTER, OG EDGE.

TR-1124	14" DIA. ROUND
---------	----------------



**ASIAN FUSION LINE SERVICE PLATES (STAINLESS)**

TR-99311	13" DIA.	ROUND
TR-99312	15" DIA.	ROUND



**OVAL TRAYS (CHROMEPLATE)**

EMBOSSED CENTER. MEDIUM WEIGHT!

TRC-5121	17 3/4" x 12 7/8" x 0.75" H. OVAL
----------	-----------------------------------



**NEW!**

**GOLD TREE BARK TRAY (TITANIUM PLATED PORCELAIN)**

THIS TRAY IS MADE FROM TITANIUM PLATED PORCELAIN AND THE TREE BARK DESIGN.

FOOD SAFE, STAIN RESISTANT, AND DISHWASHER SAFE.

TR-69013	13.25" L. X 8.75" W. X 1.25" H.
----------	---------------------------------

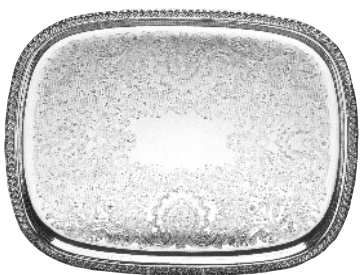

**OBLONG TRAY (STAINLESS)**

GADROON BORDER, EMBOSSED CENTER

TR-4270	23.5" x 18"
---------	-------------



**TRAY (NICKELPLATE)**

TR-275	16.5" x 12" RECTANGULAR
--------	-------------------------



**HAMMERED TRAYS (STAINLESS)**

TR-72631	18.75" x 9.5"	RECTANGULAR
TR-72632	14.25" x 7.25"	RECTANGULAR
TR-72633	16" DIA.	ROUND
TR-72637	14" DIA.	ROUND



**SQUARE TRAY (18/8 STAINLESS)**  
HEAVY DUTY.

TR-72531	11" SQUARE
----------	------------



**SOPRANO TRAYS (18/10 STAINLESS)**

A PLAIN FLAT RIM EDGING, FEATURES A RAISED RIM. MIRROR FINISH.

TR-337	12" DIA.	ROUND
TR-338	13" DIA.	ROUND
TR-340	16" DIA.	ROUND

TRSS-440	20.8" L. X 14.5" W. RECTANGULAR
----------	---------------------------------



**OBLONG TRAY (SILVERPLATE)**

PLAIN CENTER.

TR-282	11" x 6" OBLONG
--------	-----------------



**OVAL TRAY WITH HAMMERED RIM (STAINLESS STEEL)**

TR-72689	22" OVAL
----------	----------



**TRAYS (SILVERPLATE)**

TR-8242	12" x 12" SQUARE
---------	------------------

**CHIPPENDALE TRAY (NICKELPLATE)**

TR-8957	23.5" X 11.5" OVAL
---------	--------------------



**GALLERY TRAY (HIGH-POLISHED STAINLESS STEEL)**

THIS GALLERY TRAY IS DOUBLE WALLED AND MADE FROM HIGH-POLISH STAINLESS STEEL. IT WILL ADD A TOUCH OF CLASS TO YOUR NEXT EVENT.

TR-448	12 1/2" DIA. x 2 1/5" H.
--------	--------------------------

**NEW!**



**SQUARE HAMMERED TRAYS (STAINLESS)**

TRH-250	10" X 8.5"	SQUARE
TRH-251	11" X 10"	SQUARE

# BOWLS & TRAYS



### GOLDEN VINE HAMMERED TRAYS (STAINLESS)

THESE TRAYS FEATURE AN ELEGANT GOLDEN VINE PATTERN ALONG THEM AND A HAMMERED STYLE DESIGN.

TR-7389	10.75" DIA.	ROUND
TR-7390	15.25" x 5.75"	NARROW OVAL
TR-7391	16.5" x 10"	OVAL



### TRAY WITH BEAD BORDER (STAINLESS STEEL)

TR-6130	13" DIA. ROUND TRAY WITH BEAD BORDER
TR-6131	15" DIA. ROUND TRAY WITH BEAD BORDER
TR-6132	20" DIA. ROUND TRAY WITH BEAD BORDER
TR-6133	11.5" DIA. ROUND WITH BEAD RIM
TR-6134	15" DIA. ROUND WITH BEAD RIM
TR-6140	13 3/4" x 17 13/16" OBLONG WITH BEAD BORDER
TR-6141	15 3/4" x 21 1/2" OBLONG WITH BEAD BORDER



### SERVING/DISPLAY TRAYS (18/8 STAINLESS)

WAVY SURFACE TRAYS OFFER A UNIQUE PRESENTATION FOR ANY TABLE TOP.

TR-9250	12 5/8" x 7 1/4" x 1"	RECTANGULAR
TR-9251	13 3/4" x 7 3/4" x 1"	RECTANGULAR
TR-9252	15" x 8 1/2" x 1"	RECTANGULAR
TR-9253	10 1/4" x 10 1/4" x 5/8"	SQUARE
TR-9254	11 3/4" x 11 3/4" x 5/8"	SQUARE
TR-9255	13 1/4" x 11 1/4" x 5/8"	SQUARE
TR-9256	8 7/8" DIA. x 1 5/8"	ROUND
TR-9257	9 5/8" DIA. x 1 5/8"	ROUND
TR-9258	10 1/4" DIA. x 1 5/8"	ROUND



### IRONSTONE HOLLOWWARE (STAINLESS)

THE IRONSTONE HOLLOWWARE COLLECTION IS PERFECT FOR DISPLAY ON A BUFFET OR BEING USED BY THE SERVER. YOU HAVE MANY OPTIONS WITH TRAYS, BOWLS, AND EVEN A TRIANGLE PLATTER. THEY ARE MADE FROM DURABLE STAINLESS STEEL AND SOME ARE EVEN DOUBLE WALL.

TR-26450	26" SERVING TRAY
TR-26451	22" SERVING TRAY
TR-26452	15" X 13.5" DOUBLE WALL TRIANGLE PLATTER
TR-26456	11" DIA. BAR TRAY WITH SILICONE MAT
TRM-26456	11" SILICONE MAT ONLY FOR TR-26456
TR-26457	14" DIA. BAR TRAY WITH SILICONE MAT
TRM-26456	14" SILICONE MAT ONLY FOR TR-26457
BWL-26453	4.75" X 3.25" DOUBLE WALL ANGLED BOWL/WINE BOTTLE COASTER
BWL-26454	6" X 4" DOUBLE WALL ANGLED BOWL
BWL-26455	9.75" X 5.25" DOUBLE WALL ANGLED BOWL



### OVAL GALVANIZED PLATTER WITH GOLD BEAD EDGE

THIS PLATTER IS GALVANIZED STEEL WITH A GOLD BEADED EDGE. SOLD IN THE CASE PACKS OF 4 EACH ONLY.

PLT-5400  
19" X 13" X 1.25" H.



### MIRROR VANITY TRAYS FAUX DIAMOND EDGE.

MTR-7501	9" x 11"	RECTANGULAR
MTR-7502	9" x 14"	RECTANGULAR



### CRACKLE TEXTURED TRAY (STAINLESS STEEL)

THIS TRAY IS MADE FROM DURABLE STAINLESS STEEL AND HAS A CRACKLE TEXTURED DESIGN.

RTR-72412 15" DIA.

### FEATHER TRAY (GOLD ALUMINUM)

THIS FEATHER TRAY IS MADE FROM ALUMINUM GOLD AND IS A GREAT ACCENT PIECE FOR YOUR NEXT EVENT.

TR-70333 15.5" L. X 3.5" W. X 1.75" H.



### SILVER TREE BARK TRAYS (TITANIUM PLATED PORCELAIN)

THESE TRAYS ARE MADE FROM TITANIUM PLATED PORCELAIN AND THE TREE BARK DESIGN WILL ADD A UNIQUE RUSTIC DESIGN TO YOUR EVENT OR TABLETOP. THE COLLECTION OFFERS THREE SIZES TO CHOOSE FROM. THE SILVER COLOR WILL ALSO ADD A TOUCH OF ELEGANCE. THEY ARE FOOD SAFE, STAIN RESISTANT, AND DISHWASHER SAFE.

TR-69023	8.75" L. X 8" W. X 1" H.
TR-69024	13" L. X 12" W. X 1" H.
TR-69025	16" L. X 10" W. X 1" H.



**NEW!**



### DOUBLE-WALL HAMMERED STAINLESS SEAFOOD TRAYS

THESE DOUBLE-WALLED STAINLESS STEEL TRAYS ARE A GREAT WAY TO DISPLAY YOUR SEAFOOD. EACH TRAY IS SOLD SEPARATE, SO YOU CAN MIX AND MATCH FOR YOUR DISPLAY. EVEN ADD THE STAINLESS STEEL RACKS TO ADD HEIGHT TO MINIMIZE SPACE. SOLD IN CASE PACKS AS LISTED.

TR-12900	68 OZ. TRAY, 12" DIA. x 2 1/4" H.	CASE PACK 4 EACH
TR-12901	98 OZ. TRAY, 13 3/4" DIA. x 2 1/4" H.	2 EACH
TR-12902	135 OZ. TRAY, 15 1/2" DIA. x 2 1/4" H.	2 EACH
TR-12903	169 OZ. TRAY, 17 1/2" DIA. x 2 1/4" H.	2 EACH
TRR-12905	7 1/2" TOP DIA. x 9 5/8" BOTTOM DIA. x 7 3/8" H. RACK	12 EACH



### LUNAR BOWLS & TRAYS (STAINLESS STEEL WITH GOLD HANDLE)

BWL-70330	6" L. X 4.75" W. X 15" H. (6.5" L. WITH HANDLE)	DISH
BWL-70331	24 OZ., 6" DIA. X 3" H. (6.5" DIA. WITH HANDLE)	BOWL
BWL-70332	132 OZ., 10" DIA. X 4.75" H. (10.75" DIA. WITH HANDLE)	BOWL
TR-70332	11" DIA. X 1" H. (12.25" DIA. WITH HANDLE)	TRAY



### GEOMETRIC TRAY/OVAL DISH AND BOWLS (STAINLESS STEEL WITH GOLD HANDLES)

BWL-70220	24 OZ., 6" DIA. X 2.75" H. (7.5" DIA. WITH HANDLES)	BOWL
BWL-70221	132 OZ., 10" DIA. X 4.75" H. (10.75" DIA. WITH HANDLES)	BOWL
TR-70226	17.25" L. X 6.5" W. X 2" H. (18.75" L. WITH HANDLES)	TRAY

# BOWLS, TRAYS, & TRAY STANDS



## PLATTERS & BOWLS, BLUE SPECKLED WITH BLUE TRIM (WHITE MELAMINE)

THESE PLATTERS AND BOWLS ARE THE PERFECT FIT FOR ANY EVENT TO DISPLAY YOUR BEAUTIFUL CREATIONS. THEY WHITE WITH BLUE SPECKLES WITH BLUE TRIM, MADE OF NEARLY INDESTRUCTIBLE MELAMINE FOR LONG-LASTING USAGE. NOT RECOMMENDED FOR MICROWAVE USE. SOLD IN CASE PACKS ONLY.

		CASE PACK
PLT-3250	PLATTER, 6 7/8" L. X 4 1/4" W. X 1 1/8" H.	12 EACH
PLT-3251	PLATTER, 12 3/4" L. X 7" W. X 1 1/8" H.	6 EACH
PLT-3252	PLATTER, 9 7/8" SQ X 1 1/8" H.	6 EACH
PLT-3253	PLATTER, 12 3/8" L. X 10 1/4" W. X 1 1/8" H.	6 EACH
BWL-3254	BOWL, 26 OZ, 6 7/8" L. X 4 1/8" W. X 3 1/4" H.	6 EACH
BWL-3255	BOWL, 44 OZ, 6 3/8" L. X 6 7/8" W. X 3 1/4" H.	6 EACH
BWL-3256	BOWL, 64 OZ, 10 3/8" L. X 6 3/8" W. X 3 1/4" H.	6 EACH
BWL-3257	BOWL, 82 OZ, 12 5/8" L. X 6 3/4" W. X 3 1/4" H.	6 EACH
BWL-3258	BOWL, 98 OZ, 9 3/4" QQ. X 3 1/4" H.	6 EACH
BWL-3259	BOWL, 106 OZ, 15" L. X 6" W. X 3 1/4" H.	6 EACH
BWL-3260	BOWL, 131 OZ, 11 3/4" L. X 10 3/8" W. X 3 1/4" H.	6 EACH
BWL-3261	BOWL, 144 OZ, 15" L. X 8" W. X 3 1/4" H.	6 EACH
BWL-3262	BOWL, 212 OZ, 15" L. X 12" W. X 3 1/4" H.	6 EACH



## ENAMELWARE, WHITE WITH BLUE RIM

THIS ENAMELWARE COLLECTION IS VINTAGE INSPIRED AND IS THAT PERFECT WAY TO GET IN ON THE AMERICAN CLASSIC CRAZE. EACH PIECE HAS BLUE TRIM ON WHITE, WHICH IS A TIMELESS LOOK TO WORK FOR ANY OCCASION. SOLD IN THE CASE PACKS ONLY.

		CASE PACK
CHI-5540	SMALL MUG, 6 OZ., 2 7/8" DIA. X 2 3/4" H. X 3 1/2" L.	4 EACH
CHI-5541	LARGE MUG, 16 OZ., 3 5/8" DIA. X 4" H., 4 1/2" L.	4 EACH
CHI-5542	SMALL OBLONG BOWL, 6 1/4" L. X 4 7/8" W. X 1 1/2" H.	4 EACH
CHI-5543	MEDIUM OBLONG BOWL, 7 7/8" L. X 5 7/8" W. X 1 1/2" H.	4 EACH
CHI-5544	LARGE OBLONG BOWL, 10" L. X 7 5/8" W. X 1 7/8" H.	4 EACH



## TRIUMPH PATTERN BOWLS

SUPER WHITE PORCELAIN. SOLD IN CASE PACKS ONLY!

			CASE PACK
CHI-5282	15 OZ., 6" x 2 1/2"	TRIANGULAR BOWL	3 DOZ.
CHI-5283	30 OZ., 7 1/2" x 3"	TRIANGULAR BOWL	2 DOZ.
CHI-5284	54 OZ., 9" x 3 3/4"	TRIANGULAR BOWL	1 DOZ.
CHI-5285	76 OZ., 10 1/4" x 4"	TRIANGULAR BOWL	1 DOZ.
CHI-5359	6 OZ., 6"	WAVY BOWL	3 DOZ.
CHI-5404	12" DIA.	ROUND TRAY FOR WAVY BOWL	1 DOZ.
CHI-5405	8" x 7/8"	PLATE, TRIANGULAR	2 DOZ.
CHI-5406	10" x 1"	PLATE, TRIANGULAR	1 DOZ.
CHI-5407	12" x 1 1/4"	PLATE, TRIANGULAR	1 DOZ.
CHI-5408	14" x 1 3/8"	PLATE, TRIANGULAR	8 EACH



## GLASS MINI BOWL SETS

THESE MINI GLASS SETS ARE A GREAT IDEA FOR A TASTE TESTING EVENT, MINI DESSERTS, MINI APPETIZERS, OR MAYBE EVEN A CREATIVE SHOT. EACH SET COMES WITH A UTENSIL LISTED. SOLD IN THE SETS ONLY.



ACG-1540	8 PC SET	4 BOWLS AND 4 BENT FORKS, 6 OZ, 2.75" H BOWLS
ACG-1541	12 PC SET	6 BOWLS AND 6 BENT SPOONS, 2 OZ, 2.5" H BOWLS
ACG-1542	12 PC SET	6 CUPS AND 6 TALL SPOONS, 2 OZ, 4.75" H CUPS



## NON-SLIP TRAYS

TEXTURED, NON-SLIP RUBBER LINED SURFACE.

DISHWASHER SAFE AT TEMPERATURES LESS THAN 150°F.

GR-1100BK	11" DIA. ROUND	BLACK
GR-1100BR	11" DIA. ROUND	BROWN
GR-1400BK	14" DIA. ROUND	BLACK
GR-1400BR	14" DIA. ROUND	BROWN
GR-1600BK	16" DIA. ROUND	BLACK
GR-1600BR	16" DIA. ROUND	BROWN
GR-1800BK	14" x 18" RECTANGULAR	BLACK
GR-1800BR	14" x 18" RECTANGULAR	BROWN
GR-2700BK	27" OVAL	BLACK
GR-2700BR	27" OVAL	BROWN



## SLIP RESISTANT TRAYS WITH CORK

THESE NON-SLIP TRAYS HAVE A TEXTURED CORK-LINER THAT HELPS KEEP GLASSES AND DISHES IN PLACE DURING TRANSPORT. THE CORK LINER STAYS SLIP RESISTANT EVEN WHEN WE SOLD IN CASE PACKS OF 12.

TRL-912	12 5/8" DIA. x 7/8" H.	ROUND
TRL-914	14 1/4" DIA. x 3/4" H.	ROUND
TRL-916	16 1/4" DIA. x 1" H.	ROUND
TRL-91612	16 1/4" L x 11 3/4" W. x 1" H.	RECTANGULAR



## NON-SLIP TRAYS (FIBERGLASS)

NON-SLIP FIBERGLASS TRAYS ARE PERFECT FOR ANY MEAL OR DRINK SERVICE. SINCE THE FIBERGLASS TRAYS ARE DISHWASHER SAFE. SOLD IN CASE PACK OF 6 EACH.

TRF-700	11" DIA. ROUND	BROWN
TRF-701	11" DIA. ROUND	BLACK
TRF-702	14" DIA. ROUND	BROWN
TRF-703	14" DIA. ROUND	BLACK
TRF-704	16" DIA. ROUND	BROWN
TRF-705	16" DIA. ROUND	BLACK
TRF-708	22" x 26" OVAL	BROWN
TRF-709	22" x 26" OVAL	BLACK



## GRIP TITE TRAYS

PERMANENT RUBBER LINING PREVENTS SLIPPING. DISHWASHER SAFE!

GR-3100BK	31" OVAL	BLACK
GR-3100TN	31" OVAL	TAN

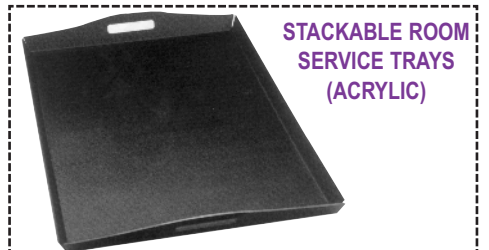

## STACKABLE ROOM SERVICE TRAYS (ACRYLIC)

TR-9301	22 1/2" x 17" x 1" H.	BLACK
TR-9302	16" x 13" x 1" H.	BLACK
TR-9303	18" x 26" x 1" H.	BLACK



## FOLDING TRAY STANDS (CHROME PLATED)

AC-3997	31" H.
AC-3998	37" H.



## FOLDING TRAY STANDS (WOOD)

AVAILABLE IN A VARIETY OF WOOD FINISHES AND WITH A LADDER DESIGN ON THE BOTTOM.

AC-480400C	CHERRY
AC-480400W	WALNUT
AC-480400M	MAHOGANY



## CHECK HOLDER TIP TRAY (STYRENE)

NSF LISTED, DISHWASHER SAFE.

TR-1757	12 5/8" DIA. x 7/8" H., WITH CLIP	COLOR ONLY BLACK
TR-1850	4 1/2" x 6 1/2", WITHOUT CLIP	BLACK (01), OR BROWN (03)

# CHARGER PLATES & NAPKIN RINGS



**ROUND CHARGER PLATES (ACRYLIC)**  
SOLD IN CASE PACKS OF 24.

- TR-6620 13" DIA. ROUND, RED, PLAIN EDGE
- TRBL-6651 13" DIA. ROUND, BLUE, PLAIN EDGE
- TRBR-6651 13" DIA. ROUND, BROWN, PLAIN EDGE
- TRS-6651 13" DIA. ROUND, SILVER, PLAIN EDGE
- TRG-6651 13" DIA. ROUND, GOLD, PLAIN EDGE
- TRPK-6651 13" DIA. ROUND, PINK, PLAIN EDGE
- TRPL-6651 13" DIA. ROUND, PURPLE, PLAIN EDGE
- TRRB-6651 13" DIA. ROUND, RASPBERRY, PLAIN EDGE
- TRC-6651 13" DIA. ROUND, COPPER PLAIN EDGE
- TRW-6651 13" DIA. ROUND, WHITE, PLAIN EDGE
- TR-6658 13" DIA. ROUND, BLACK, PLAIN EDGE
- TR-6663 13" DIA. ROUND, GREEN, PLAIN EDGE
- TRB-6655 13" DIA. ROUND, BLACK, BEADED EDGE
- TRC-6655 13" DIA. ROUND, COPPER, BEADED EDGE
- TRG-6655 13" DIA. ROUND, GOLD, BEADED EDGE
- TRR-6655 13" DIA. ROUND, RED, BEADED EDGE
- TRS-6629 13" DIA. ROUND, SILVER, BEADED EDGE

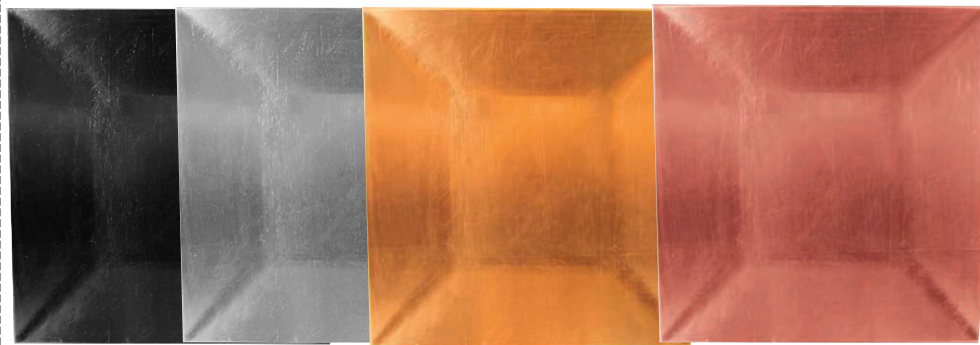

**CHARGER PLATES (ACRYLIC)**  
FIT SQUARE PLATES. SOLD IN CASE PACKS OF 24.

- |          |               |        |
|----------|---------------|--------|
| TRS-6670 | 12.75" SQUARE | SILVER |
| TRG-6670 | 12.75" SQUARE | GOLD   |
| TRB-6670 | 12.75" SQUARE | BLACK  |
| TRC-6670 | 12.75" SQUARE | COPPER |

**MATCHES ALL NAPKIN RINGS!**



**NAPKIN RINGS (ACRYLIC)**  
1.75" DIA. x 1" W. SOLD IN CASE PACK 2 DOZEN ONLY.

- |          |        |           |       |
|----------|--------|-----------|-------|
| AC-6512S | SILVER | AC-6512BL | BLUE  |
| AC-6512G | GOLD   | AC-6512BR | BROWN |
| AC-6512B | BLACK  | AC-6512FG | GREEN |
| AC-6512C | COPPER | AC-6512PK | PINK  |

**MATCHES ALL CHARGERS!**

- |           |           |
|-----------|-----------|
| AC-6512PL | PURPLE    |
| AC-6512R  | RED       |
| AC-6512RB | RASPBERRY |
| AC-6512W  | WHITE     |

## CHARGER CRATES

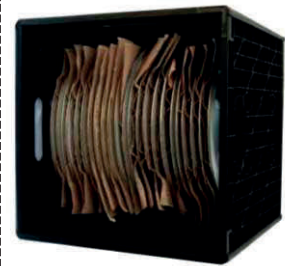

**FITS CHARGER PLATES**

**CHARGER PLATE CRATES**

FITS CHARGERS THAT ARE UP TO 13" DIAMETER. GREAT FOR STORAGE AND TRANSPORT.

- |          |   |   |
|----------|---|---|
| *AC-8021 | SQUARE, PLASTIC, BLACK COLOR, 27 SLOTS  | OUTSIDE: 14.5" L. x 14.5" L. x 14.5" HT., INSIDE: 13.5" L. x 13.5" W. x 13.5" HT. |
| AC-8022  | RECTANGULAR, PLASTIC, BLACK COLOR, 37 SLOTS   | OUTSIDE: 19" L. x 13" W. x 12" HT., INSIDE: 18 1/8" L. x 12" W. x 11" HT.         |
| AC-8024  | DIVIDER FOR AC-8021 CRATE ONLY, SET OF 6  | *NOTE AC-8021 MAY NEED DIVIDERS   |
| AC-8023  | SQUARE, 24 SLOTS, POLY RESIN, BLACK COLOR   | OUTSIDE: 12" L. X 12" W. X 12" H., INSIDE: 11" L. X 11" W. X 11" H.               |
| DB-91312 | 15.5" x 14.5" x 14", GREEN PLASTIC COATED WIRE CHARGER PLATE RACK                                   |   |
| DB-91214 | 12 COMPARTMENT WIRE EPOXY DISH BASKET, FITS PLATTERS UP TO 14" DIA., EXTRA LARGE CHARGER PLATE RACK |   |



**CHARGER PLATES (CHROMEPLATE)**  
HEAVYWEIGHT. DISHWASHER SAFE.  
SOLD AS SET OF 4 ONLY  
TRN-430 13" DIA. ROUND



**GALVANIZED STEEL CHARGER PLATE WITH GOLD BEAD EDGE**  
SOLD IN CASE PACKS OF 24 EACH ONLY.  
TR-54700 13" DIA. ROUND



**CHARGER PLATES (HIGH POLISHED SILVERPLATE)**  
SOLD AS SET OF 4 ONLY  
TR-498 11.75" DIA. ROUND.



**HAMMERED CHARGER PLATE (STAINLESS STEEL)**  
SSC-72608 13.5" DIA. ROUND

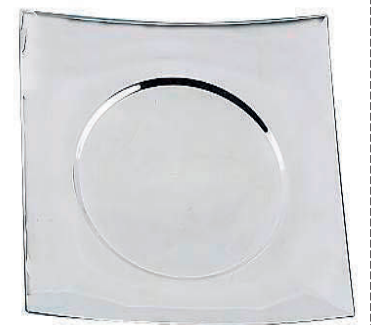

**NON-TARNISH CHARGER (NICKELPLATE)**  
TR-82551 13" SQUARE



**NICKELPLATED CHARGERS GOLDPLATED BEADED EDGE**  
THESE NICKELPLATED CHARGER PLATES HAVE A GOLDPLATED BEADED EDGE.  
SOLD AS A SET OF 4.  
TR-1070 12" DIA.



**BEAD CHARGER (NICKELPLATE)**  
TARNISH FREE  
NICKELPLATED FOR CONVENIENT USAGE.  
SILVER FINISH GIVES AN ENHANCED APPEAL.  
SOLD AS SET OF 4 ONLY!  
TRNB-8250 12" DIA.



**METALLIC GREY WITH GLITTER EDGE (GLASS)**  
GLC-31181 13" DIA. SET/4



**METALLIC GOLD WITH GLITTER EDGE (GLASS)**  
GLC-31182 13" DIA. SET/4

# CHARGER PLATES (GLASS)

ADD CONTEMPORARY FOOD SAFE ACCENTS TO ANY TABLETOP WITH THESE DECORATIVE AND ELEGANT UNIQUE GLASS CHARGER PLATES. ADD A TOUCH OF WARMTH WITH AN ENCHANTING DESIGN THAT HAS ARTISTIC APPEAL. A PERFECT TABLETOP COMPLEMENT TO ENHANCE FOOD PRESENTATION! HAND WASH ONLY.

**GOLD FOIL**

GLC-20000 13" DIA. SET/8



**NEW!**

**GOLD DIAMOND RIM**

GLC-20001 13" DIA., SET/8



**NEW!**

**GOLDEN SUNBURST**

GLC-20002 13" DIA., SET/8

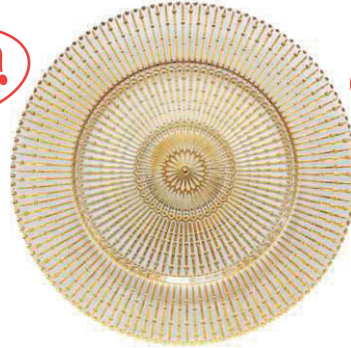

**NEW!**

**TEXTURED CHAMPAGNE**

GLC-20003 13" DIA., SET/8

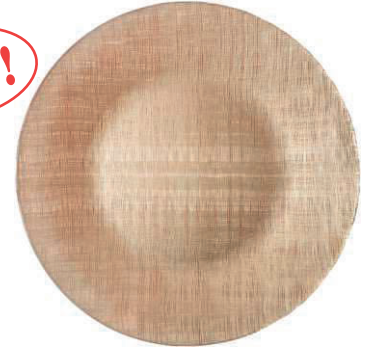

**SILVER LUXURY**

GLC-20004 13" DIA., SET/8

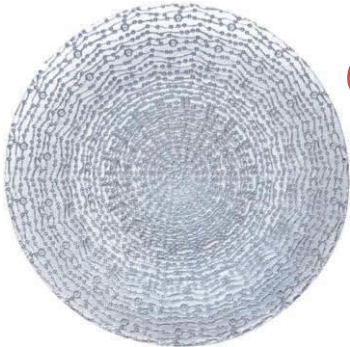

**NEW!**

**ROSE GOLD LINES**

GLC-20005 13" DIA., SET/8



**NEW!**

**ROSE GOLD FOIL**

GLC-20006 13" DIA., SET/8



**NEW!**

**ROSE GOLD DIAMOND RIM**

GLC-20007 13" DIA., SET/8



**ROSE GOLD SPARKLE**

GLC-20008 13" DIA., SET/8

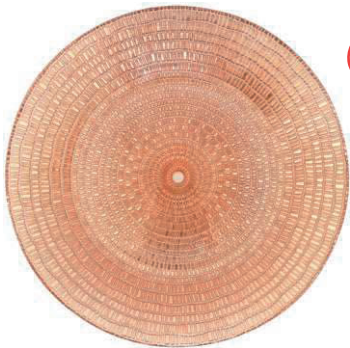

**NEW!**

**ROSE GOLD GEM**

GLC-20009 13" DIA., SET/8

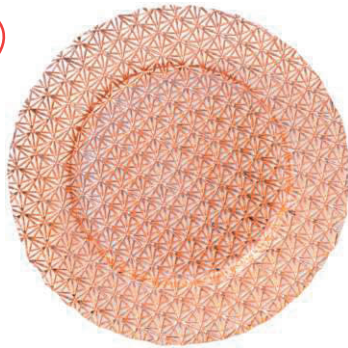

**NEW!**

**ROSE GOLD SUNRAY**

GLC-20010 13" DIA., SET/8



**NEW!**

**ROSE GOLD RIM**

GLC-20011 13" DIA., SET/8



CLEAR CHARGE WITH ROSE GOLD RIM

**ETCHED RIM W/GOLD EDGING**

GLC-31111 13" DIA., SET/4



**ETCHED RIM W/SILVER EDGING**

GLC-31112 13" DIA., SET/4



**PLAIN RIM W/GOLD EDGING**

GLC-31121 13" DIA., SET/4



**PLAIN RIM W/SILVER EDGING**

GLC-31122 13" DIA., SET/4



**LUSTER GOLD**

GLC-31131 13" DIA., SET/4



**LUSTER SILVER**

GLC-31132 13" DIA., SET/4



**ROPE GOLD**

GLC-31141 13" DIA., SET/4



**ROPE SILVER**

GLC-31142 13" DIA., SET/4

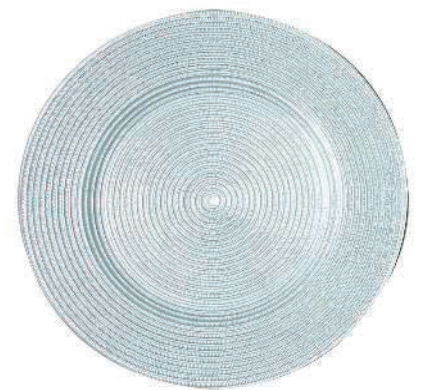

# CHARGER PLATES (GLASS)

ADD CONTEMPORARY FOOD SAFE ACCENTS TO ANY TABLETOP WITH THESE DECORATIVE AND ELEGANT UNIQUE GLASS CHARGER PLATES. ADD A TOUCH OF WARMTH WITH AN ENCHANTING DESIGN THAT HAS ARTISTIC APPEAL. A PERFECT TABLETOP COMPLEMENT TO ENHANCE FOOD PRESENTATION! HAND WASH ONLY.

**KENTON GOLD**

GLC-31155 13" DIA. SET/4



**KENTON SILVER**

GLC-31156 13" DIA. SET/4

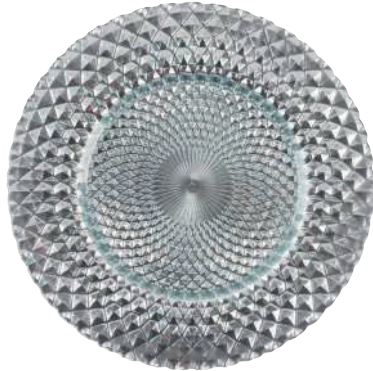

**ROSE GOLD**

GLC-31157 13" DIA. SET/4



**FRANKFORD GOLD**

GLC-31165 13" DIA. SET/4



**FRANKFORD SILVER**

GLC-31166 13" DIA. SET/4

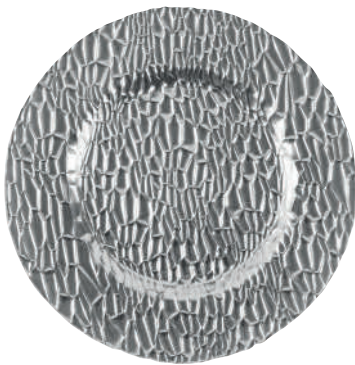

**ROSE GOLD WITH GLITTER**

GLC-31183 13" DIA., SET/4



**ATLAS GOLD**

GLC-31230 13" DIA., SET/4



**ROSE GOLD WITH WHITE LACE**

GLC-31193 13" DIA., SET/4



**ROYAL BROWN**

GLC-45000 13" DIA. SET/4



**GOLD SPONGE**

GLC-45001 13" DIA., SET/4

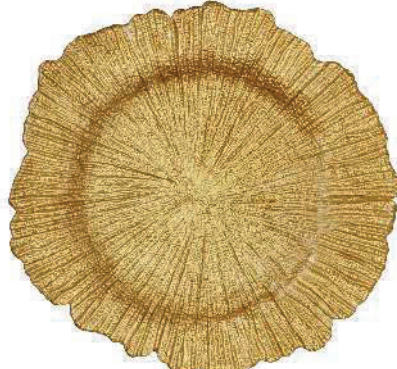

**SILVER SPONGE**

GLC-45002 13" DIA., SET/4



**SUNBURST SILVER**

GLC-45003 13" DIA., SET/4



**SUNBURST GOLD**

GLC-45004 13" DIA., SET/4



**WHITE W/TWINKLE GLITTER**

GLC-45005 13" DIA., SET/4



**GOLD BEADED**

GLC-46000 13" DIA., SET/4



**SILVER BEADED**

GLC-46001 13" DIA., SET/4



**CLEAR BEADED**

GLC-46002 13" DIA., SET/4



## MIRROR FINISHED GLASS CHARGER PLATES - HAND WASH ONLY!

**DIAMOND RIM**

MCH-7500 13" DIA.



**BEVEL BLOCK**

ACM-1301 13" DIA.



**SQUARE DECO**

ACM-1302 13" SQ.



**SQUARE TWISTED**

ACM-1303 13" SQ.



**SCALLOPED**

ACM-1304 13" DIA.



# BASKETS

**WIRE BASKETS (18/8 STAINLESS STEEL)**  
CONSTRUCTED FROM 18/8 STAINLESS STEEL WITH A WEIGHTED BASE. HAND WASH ONLY.

BA-250	BREAD STICK	3.5" L. x 3.75" W. x 5" H.	POLISHED
BA-251	OVAL	9" L. x 7" W. x 3.5" H.	POLISHED
BA-252	ROUND WAVY	7" L. x 7" W. x 3.3" H.	BRUSHED
BA-253	ROUND WAVY	9" L. x 9" W. x 3.75" H.	BRUSHED
BA-254	ROUND	7" L. x 7" W. x 3.25" H.	POLISHED
BA-255	ROUND	8.5" L. x 8.5" W. x 3.75" H.	POLISHED

**BASKETS (CHROMEPLATED)**  
HAND WASH ONLY!

BA-4170	7.25" x 5.5" x 2.5" H.	OVAL
BA-4171	8.75" x 6.25" x 2.75" H.	OVAL
BA-4172	11.25" x 8" x 3.25" H.	OVAL
BA-4173	8.25" x 2.75" H.	ROUND
BA-4174	9.75" x 3" H.	ROUND

**OVAL BASKET (NICKELPLATE)**  
MADE OF A TARNISH RESISTANT NICKELPLATED MATERIAL. THIS BASKET IS EXTREMELY EASY TO MAINTAIN AND IS DISHWASHER SAFE!

BA-85191 9" x 7" OVAL

**BASKETS (STAINLESS STEEL)**  
COMMERCIAL DISHWASHER SAFE.

BA-4300	7" DIA. x 7" HT., ROUND
BA-4301	7" DIA. x 3" HT. ROUND
BA-4302	8.5" L. x 6" W. x 3" HT., OVAL
BA-4305	9" DIA. x 8.5" HT., ROUND
BA-493	7" DIA. x 5" H., ROUND
BA-422780	5.375" DIA. x 3" H., ROUND
BA-422782	6.25" DIA. x 4.25" H., ROUND

**BASKETS (18/8 STAINLESS)**

**DISHWASHER SAFE!**

BASS-501	6 5/8" x 2 3/4" H.
BASS-502	8" x 2 7/8" H.
BASS-503	11" x 4 1/4" H.
BASS-504	8 1/4" x 5 1/8" x 2 1/2" H.
BASS-505	9" x 5 7/8" x 2 5/8" H.
BASS-506	13 3/8" x 9 1/4" x 4 1/4" H.

**BASKETS**  
GREAT FOR BREADS AND ROLLS.

BA-233	9.25" DIA. ROUND	SILVERPLATE
BA-235	11" X 7.25" OVAL	SILVERPLATE
BA-530	7.5" x 11.75" OVAL	NICKELPLATE

**LEAVES COLLECTION BASKETS AND PLATTER**  
THESE ARE NICKELPLATED OVER STAINLESS STEEL SO THEY ARE EASY TO CLEAN.

LV-700	ROUND BASKET 11.25" X 5"
LV-701	OVAL BASKET 15.5" x 7.5" x 5"
LV-702	OVAL PLATTER, 12" x 8.5" x 1"

**GOLDEN FACETS COLLECTION**

ACG-72400	LONG BOAT, 16" L.
ACG-72401	LONG BOAT, 18" L.
ACG-72402	ROUND BASKET, 11" DIA.
ACG-72403	PLATTER, 22" L.

**GO-GO BASKETS (METAL)**  
SOLD IN CASE PACKS OF 24 EACH ONLY!

BA-800	8" DIA. x 2 7/8" H.	ROUND	SILVER	CASE PACK 12 EACH
BA-801	9" L. x 6" W. x 3" H.	OVAL	SILVER	CASE PACK 12 EACH
BA-802	8" DIA. x 2 7/8" H.	ROUND	BLACK	CASE PACK 12 EACH
BA-803	9" L. x 6" W. x 3" H.	OVAL	BLACK	CASE PACK 12 EACH

**BASKETS AND PLATTER (BLACK STEEL)**

BS-7000	ROUND BASKET, 9.5" DIA.
BS-7001	ROUND BASKET, 11" DIA.
BS-7002	OVAL PLATTER, 17" x 10.5" x 3"

**ROUND BUCKET BASKETS (BLACK IRON COATED)**  
RECOMMENDED HANDWASH ONLY

BA-433780	5.375" DIA. x 3" H.
BA-433782	6.25" DIA. x 4.25" H.
BA-433787	7" DIA. x 7" H.

**NEW!**  
**OVAL BASKETS (BRONZE FINISH WIRE)**

BA-9850	9" L. X 6" W. X 2 1/4" H.
BA-9851	11" L. X 8" W. X 2 1/2" H.

**TUSCAN STYLE BREAD BASKET (BLACK IRON POWDER COATED)**  
RECOMMENDED HANDWASH ONLY!

BA-431892 8.5" x 5.5" x 3" H. SHORT OVAL

**ROUND BRONZE WIRE BASKETS**

BA-9800C	5" DIA. X 3 1/8" H.
BA-9801C	7" DIA. X 4 1/4" H.

**RADIANCE BASKET COLLECTION (STAINLESS STEEL)**  
THESE RADIANCE BASKETS ARE CONSTRUCTED FROM STAINLESS STEEL AND ARE GREAT FOR ANY EVENT. THEY CAN BE USED AS A BASKET OR EVEN A CENTERPIECE!

RD-7250	9.75" DIA. X 2.5"	ROUND
RD-7251	14" DIA x 2.5"	ROUND

**BASKET (BLACK IRON POWDER COATED)**  
RECOMMENDED HANDWASH ONLY

BA-431872 9.5" DIA. x 2.75" H.

**BREAD BASKET (BLACK POWDER COATED WIRE)**

BA-2200 6.5" DIA X 3.5" H.

**BREAD OVAL BOWL (18/8 STAINLESS)**  
THIS 18/8 MIRROR FINISH STAINLESS STEEL. IDEAL FOR BREADS, ROLLS AND FRUIT. GREAT FOR TABLETOP OR BUFFET.

AC-3471 11 11/16" x 7" x 2 5/16", 55 OZ.

**BLACK WIRE BASKETS**

BA-9800	OVAL	9" L. X 6" W. X 2 3/4" H.
BA-9801	ROUND	8" DIA. X 2 3/4" H.



# BASKETS



BA-887

BA-888

BA-890



BA-891

BA-893

**CONICAL BASKETS (BLACK WROUGHT IRON)**

- BA-887 7" W. x 6" H.
- BA-888 9" W. x 4" H.
- BA-890 5" DIA. x 9" H., 1 - CONE
- BA-891 10 1/2" DIA. x 9 1/2" H., 2 - CONE
- BA-893 5" DIA. x 9 3/8" H., 1 - CONE WITH 2 RAMEKINS
- BA-894 REPLACEMENT RAMEKIN, 3 OZ. CAPACITY FOR ITEM BA-893

BA-894

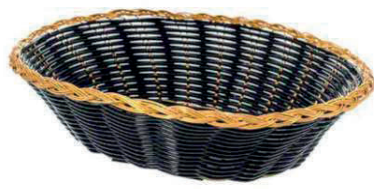

**OVAL BASKET (BLACK POLY WOVEN WITH GOLD RIM)**  
WIRE REINFORCED. TRADITIONAL!  
SOLD SET OF 12.  
BA-1592 8 3/4" L. x 3 7/8" W. x 2" H.



**BREAD STICK HOLDER (18/8 STAINLESS)**

BA-750  
3.25" x 5.25"

**TUSCAN STYLE STACKABLE BREAD BASKET (STAINLESS)**



BA-488840  
8.25" x 5" x 5"



**WEAVEAR™ BASKETS (POLYPROPYLENE)**

A SAFE ALTERNATIVE TO WICKER AND PLASTIC COATED WIRE. COLORS: BLACK(03), BROWN (01), GREEN(09), RED(05), STRAW(67). PLEASE SPECIFY COLOR WHEN ORDERING.

- BA-1541 9" x 6 1/4" OVAL
  - BA-1542 9" DIA. ROUND
  - BA-1543 12" DIA. ROUND
  - PL-1544 10 3/8" DIA. ROUND
- \*WIDE DIAMETER AND RAISED BOTTOM



**BREAD BASKETS(PLASTIC)**

- SOLD IN SETS OF 12 ONLY.
- AC-36601 BROWN, 9.5" L. x 5" W. x 2" DEEP
  - AC-36604 YELLOW, 9.5" L. x 5" W. x 2" DEEP
  - AC-36605 RED, 9.5" L. x 5" W. x 2" DEEP
  - AC-36609 GREEN, 9.5" L. x 5" W. x 2" DEEP



**TEXTURED BASKETS (POLYPROPYLENE)**

DISHWASHER & MICROWAVE SAFE. SOLD IN CASE PACKS OF ONE DOZEN. PLEASE SPECIFY COLOR WHEN ORDERING: BLACK(BK) OR TERRA COTTA (TERRA).

- WB-1520 7.27" DIA. , 6" SERVING AREA, 1.25" INSIDE DEPTH
- WB-1521 9" DIA. ROUND, 7" SERVING AREA, 1.25" INSIDE DEPTH
- WB-1522 10.5" DIA. ROUND, 8.5" SERVING AREA, 1.25" INSIDE DEPTH
- WB-1523 10.5" DIA. ROUND, 1.25" DEEP
- WB-1524 12" DIA., ROUND 1.5" DEEP
- WB-1525 8" x 4.5" RECTANGULAR, 2" DEPTH, BLACK ONLY



**BASKETS (WROUGHT IRON)**  
BLACK LEAF OR BLACK SCROLL DESIGN. THIS WROUGHT IRON ROUND BASKET IS EXTREMELY ATTRACTIVE AND WILL CHANGE THE WAY YOU SERVE BREAD, ROLLS, AND BISCUITS! SERVE YOUR FOODS WITH A SENSE OF STYLE AT BANQUETS, RESTAURANTS, PARTIES, BUFFETS AND MORE!

- BA-865 ROUND BLACK SCROLL 8" DIA. x 3" H.
- BA-866 ROUND BLACK SCROLL 9" DIA. x 3 5/8" H.
- BA-895 ROUND BLACK LEAF 8" DIA. x 3" H.
- BA-896 ROUND BLACK LEAF 9" DIA. x 3 5/8" H.
- BA-868 OVAL BLACK SCROLL 9" W. x 6 3/4" L.
- BA-898 OVAL BLACK LEAF 9" W. x 6 3/4" L.



**MEDITERRANEAN COLLECTION BASKETS (BLACK POWDER COATED METAL)**

BA-715

- BA-713 2 TIERED WITH LEGS, 10" & 12", 25" H.
- BA-714 2 TIERED, 9" & 10 1/2" BASKETS, 12" H.
- BA-715 3 TIERED WITH LEGS, 10", 12" & 14", 34" H.

BA-713

BA-714



**ECONOMY**

**BASKETS (TAN POLY WOVEN)**

WICKER APPEARANCE. MUST BUY IN CASE PACKS OF 12.

- CD-RB94 9" x 4 1/2" x 2" LONG OVAL CASE PACK 12 EACH
- CD-RB96 9 1/2" x 6 1/2" x 2 3/4" OVAL CASE PACK 12 EACH



**OBLONG BASKETS WITH HANDLES (POLY WOVEN)**

- BA-1585 12" x 8" x 3" OBLONG
- BA-1586 16" x 11" x 3" OBLONG

# BOWLS



**BAMBOO ANGLED BOWLS (BAMBOO)**

EACH BOWL IS ANGLED TO GIVE IT A UNIQUE AND GEOMETRICAL PATTERN. SOLD IN CASE PACKS ONLY!

- BWL-1120 8 OZ. 5" DIA. X 3 1/2" H. CASE PACK 8 EACH
- BWL-1121 22 OZ. 8 1/4" DIA. X 5 3/8" H. CASE PACK 6 EACH
- BWL-1122 48 OZ. 9 3/4" DIA. X 6 1/8" H. CASE PACK 6 EACH
- BWL-1123 80 OZ. 11 1/2" DIA. X 7 1/4" H. CASE PACK 4 EACH

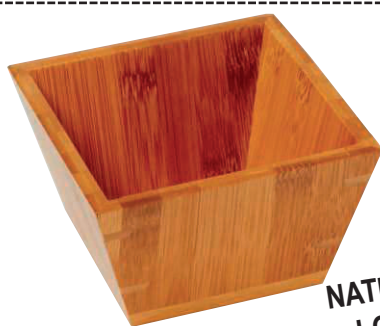

**BAMBOO BOWLS**

**NATURAL LOOK**

- BWL-7600 23 OZ. 5" SQ. x 2 7/8" H.
- BWL-7601 58 OZ. 7" SQ x 3 3/8" H.
- BWL-7602 125 OZ. 9 1/2" SQ. x 4" H.
- BWL-7603 228 OZ. 12" SQ. x 4 1/2" H.



**SALAD BOWLS (MELAMINE)**

DISHWASHER SAFE IMPACT-RESISTANT MELAMINE BOWLS ARE IN COMPLIANCE WITH FDA STANDARD. MUST BUY IN CASE PACKS OF 12.

- SB-1156 12 OZ. 5.75" DIA. NATURAL
- SB-1157 12 OZ. 5.75" DIA. BLACK
- SB-1159 14 OZ. 6" DIA. NATURAL
- SB-1160 14 OZ. 6" DIA. BLACK
- SB-1162 34 OZ. 8" DIA. NATURAL
- SB-1163 34 OZ. 8" DIA. BLACK



**10 PC. MIXING BOWL (GLASS)**

- 10 BOWLS: 1 EACH OF: 1 OZ., 2 OZ., 4 OZ., 6 OZ., 10 OZ., 16 OZ., 1 1/2 QT., 2 1/2 QT., 3 1/2 QT., AND 4 1/2 QT.  
BWL-1130

# BOWLS



**WAVY SQUARE BOWLS (WHITE PORCELAIN)**

CHI-13924	5.5" SQUARE x 3" H.	25 OZ.
CHI-13925	8.5" SQUARE x 3.75" H.	87 OZ.
CHI-13926	10.5" SQUARE x 4 3/8" H.	162 OZ.
CHI-13927	12" SQUARE x 4 7/8" H.	228 OZ.



**SQUARE BOWLS & SQUARE SAUCE CUPS (WHITE PORCELAIN)**  
SOLD IN CASE PACKS ONLY!

CHI-13903	3" SQ., 3 OZ. BOWL	CASE PACK 36 EACH
CHI-13904	6" SQ., 25 OZ. BOWL	12 EACH
CHI-13905	9" SQ., 85 OZ. BOWL	6 EACH
CHI-13906	12" SQ., 194 OZ. BOWL	4 EACH
CHI-13907	1" SQ., 1.5 OZ. SAUCE CUP	48 EACH
CHI-13908	2 1/2" SQ., 2 OZ. SAUCE CUP	36 EACH



**HAMMERED FINISH SERVING BOWL, DOUBLE WALL (STAINLESS STEEL)**  
BWL-7610 15" DIA.



**HAMMERED OVAL BOWL (STAINLESS STEEL)**  
BWL-72670 8" OVAL



**HAMMERED FINISH SERVING BOWL, DOUBLE WALL (STAINLESS STEEL)**  
BWL-72604 13" DIA.



**SOLID BOWLS (STAINLESS STEEL)**  
BWL-5220 40 OZ. 7" W. x 2 1/8" H.  
BWL-5240 67 OZ. 9" W. x 2 3/4" H.  
BWL-5260 126 OZ. 11" W. x 3" H.



**SQUOUND BOWLS (CERAMIC)**

CHI-13916	20 OZ.	7" DIA.
CHI-13917	44 OZ.	9" DIA.
CHI-13918	76 OZ.	10.75" DIA.
CHI-13919	122 OZ.	13" DIA.
CHI-13920	208 OZ.	15" DIA.

**BALTI DISHES (18/2 HIGH POLISH STAINLESS STEEL)**  
DISHWASHER SAFE.

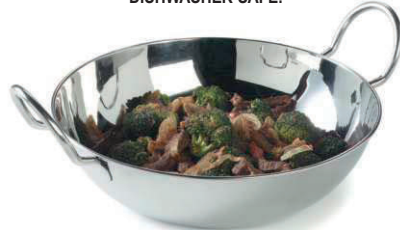

DW-609092	20 OZ.	6" DIA.
DW-609093	30 OZ.	6.75" DIA.
DW-609094	44 OZ.	7.5" DIA.
DW-609096	72 OZ.	9.5" DIA.
DW-609097	96 OZ.	10.25" DIA.



**SERVING BOWL, DOUBLE WALL (HAMMERED FINISH STAINLESS STEEL)**  
BWL-72601 11" DIA.

**AU GRATIN DISHES (STAINLESS STEEL)**

THE AU GRATIN DISHES ARE OVEN SAFE TO TEMPERATURES OF 450°F.

DS-AR060	6 OZ.	6 3/4" DIA. x 5 1/2" TOP OD	ROUND
DS-AR080	8 OZ.	7 1/4" DIA. x 5 5/8" TOP OD	ROUND
DS-AR100	10 OZ.	6 7/8" DIA. x 6" TOP OD	ROUND
DS-AO080	8 OZ.	8" L. x 4 1/2" W. x 1" H.	OVAL
DS-AO120	12 OZ.	9" L. x 5" W. x 1" H.	OVAL
DS-AO150	15 OZ.	10" L. x 5" W. x 1" H.	OVAL



**GOLDEN VINE HAMMERED SERVING BOWLS (STAINLESS)**

BWL-7382	TRIPLE NUT BOWLS, 8.25" W.
BWL-7390	SIX NUT BOWLS, 8.75" W.
BWL-7386	12" ROUND SALAD BOWL
BWL-7387	6.5" ROUND SALAD BOWL
BWL-7391	6.25" x 4.25" OVAL NUT BOWL
BWL-7384	5.125" x 1.25" H. ROUND
BWL-7383	5" DIA. POT



**HAMMERED WAVE BOWLS (STAINLESS STEEL)**  
DISHWASHER SAFE AND WILL NOT RUST OR TARNISH.

BWL-72603	10"
BWL-72655	8" x 8" x 4"
BWL-72656	5.5"



**DISPOSABLE SNACK BOWL (PLASTIC)**  
DP-510 8 OZ.



**SILVER OR GOLD TREE BARK BOWLS (TITANIUM PLATED PORCELAIN)**

FOOD SAFE, STAIN RESISTANT, AND DISHWASHER SAFE.

**NEW!**



BWL-69020	SILVER 16 OZ., 5" DIA. X 3" H.
BWL-69021	SILVER 48 OZ., 8" DIA. X 4" H.
BWL-69022	SILVER 96 OZ., 10.5" DIA. X 4.5" H.
BWL-69010	GOLD 16 OZ., 5" DIA. X 3" H.
BWL-69011	GOLD 48 OZ., 8" DIA. X 4" H.
BWL-69012	GOLD 96 OZ., 10.5" DIA. X 4.5" H.



**MELAMINE WHITE**

**SERVING BOWLS (MELAMINE WHITE)**  
THEY ARE MADE OF BREAK RESISTANT MELAMINE WHICH IS ALSO NSF CERTIFIED AND BPA FREE. THEY ARE SAFE FOR A COMMERCIAL DISHWASHER.

BWL-6500	2 QT.	15" x 8" x 2" DEEP	OVAL BOWL
BWL-6501	4 QT.	15.75" x 9" x 2.8" DEEP	OVAL BOWL
BWL-6502	6 QT.	16.75" x 10" x 3.5" DEEP	OVAL BOWL
BWL-6503	4 QT.	11" DIA. x 3.9" DEEP	ROUND BOWL
BWL-6504	11 QT.	18" DIA. x 3.9" DEEP	ROUND BOWL

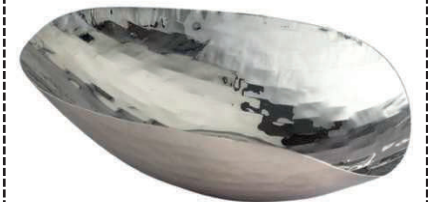

**KASA BOWLS (STAINLESS)**

BWL-7280	14" x 9" x 3.25"
BWL-7281	7" x 10.75" x 4.5"



**HAMMERED FINISH SERVING BOWLS (STAINLESS STEEL)**

BWL-880	34 OZ.	8 1/2" DIA. x 1 5/8" H.
BWL-885	85 OZ.	12 1/8" DIA. x 2 1/4" H.
BWL-890	168 OZ.	16 1/4" DIA. x 2 3/4" H.



**MIXING BOWL WITH NON-SKID SILICONE BOTTOMS (STAINLESS STEEL)**

BLACK MOLDED-ON SILICONE BOTTOMS PROVIDE A NON-SKID GRIP TO KEEP BOWLS IN PLACE DURING USE. SOLD IN CASE PACKS ONLY!

BW-873SBK	8 QT., 12" x 5 1/2" H.,	CASE PACK 6 EACH
BW-875SBK	3 PIECE SET, INCLUDES: 2 QT. 4 QT., & 6 QT.	4 SETS



**MIXING BOWLS (STAINLESS)**

AC-1	1.5 QT.	7 3/4" DIA. X 2 1/2" DEPTH
AC-3	3 QT.	9 1/2" DIA. X 3 1/2" DEPTH
AC-4	4 QT.	10 5/8" DIA. X 3 1/2" DEPTH
AC-5	5 QT.	11 1/2" DIA. X 3 1/2" DEPTH
AC-8	8 QT.	13 1/4" x 4 1/8" DEPTH
AC-13	13 QT.	14 3/4" DIA. X 3 1/2" DEPTH
AC-15	16 QT.	17 3/4" DIA. X 5" DEPTH
AC-20	20 QT.	18 5/8" DIA. X 5 1/2" DEPTH



**SQUARE BOWL (STAINLESS)**

RBSQ-72111	3.5"
RBSQ-72112	4.5"
RBSQ-72115	9"
RBSQ-72116	11"



**SUGAR BOWL, ROLL TOP (STAINLESS STEEL)**

ACSS-30	20 OZ.
---------	--------



**HAMMERED TRAY WITH 3 BOWL SET (STAINLESS STEEL)**

TRAY: 10.5" X 4.25"
BOWLS: 3.5" DIA. X 1.75" H.
BWL-72505

# BOWLS



### PEBBLED BOWLS (ACRYLIC)

HEAT POLISHED WITH HIGH GLOSS RIM ON BOWLS. DISHWASHER SAFE ACRYLIC WITH A PEBBLED FINISH TO RESIST SCRATCHES. DISHWASHER SAFE AND OR USE IN TEMPERATURES FROM 32° TO 160°F. COLOR: CLEAR. \*BWL-7176, BWL-7178 ALSO IN BLACK. PLEASE SPECIFY COLORS WHEN ORDERING.

BWL-7066	0.5 QT.	6" DIA. x 1.52" H.	ROUND
BWL-7068	1.4 QT.	8" DIA. x 2.50" H.	ROUND
BWL-7070	2 QT.	10" DIA. x 2.60" H.	ROUND
BWL-7072	4 QT.	12" DIA. x 3.95" H.	ROUND
BWL-7074	7 QT.	14" DIA. x 4.32" H.	ROUND
BWL-7076	10 QT.	16" DIA. x 5.25" H.	ROUND
BWL-7078	15 QT.	18" DIA. x 6.80" H.	ROUND
BWL-7079	24 QT.	22" DIA. x 6.22" H.	ROUND
*BWL-7172	5.5 QT.	10 1/2" x 14" x 4.80" H.	OVAL
*BWL-7176	11 QT.	13" x 18" x 4.62" H.	OVAL
BWL-7178	15 QT.	15 1/4" x 21 7/8" x 5" H.	OVAL

### PETAL MIST BOWLS & PLATES

DELICATE DESIGN GIVES AN ELEGANT APPEARANCE, PERFECT FOR BUFFETS, FOOD BARS, DELIS, POOLSIDE, AND CATERING. MADE OF TOUGH, BREAK-RESISTANT POLYCARBONATE WITH A TEXTURED EXTERIOR AND SMOOTH INTERIOR. SAFE FOR USE IN FREEZERS AND IN TEMPERATURES FROM 40° TO 212° F, DISHWASHER SAFE. NSF LISTED. SPECIFY COLOR WHEN ORDERING: BLACK(03) OR CLEAR (07).



DW-6904	18 OZ., 6" DIA. x 2" H. BOWL
DW-6907	24 OZ., 8" DIA. x 1.25" H. SOUP/SALAD BOWL, CLEAR ONLY
DW-6908	1.3 QT., 7 7/16" DIA. x 2.68" BOWL
DW-6909	2.4 QT., 9" DIA. x 3.5" H. BOWL
DW-6931	3.4 QT., 9 3/4" DIA. x 5.62" H. BELL BOWL
DW-6914	5.7 QT., 11 15/16" DIA. x 4.18" H. BOWL
DW-6917	9.8 QT., 15" DIA. x 5.18" H. BOWL
DW-6919	17.2 QT., 18" DIA. x 6.25" H. BOWL
DW-6942	12 13/16" DIA. x 0.75" H. PLATE, CLEAR ONLY
DW-6947	21 15/16" L. x 15 15/16" W. x 0.62" H. RECTANGULAR, CLEAR ONLY
DW-6954	7 11/16" DIA. x 0.81" H. PLATE, CLEAR ONLY
DW-6956	9" DIA. x 0.81" H. PLATE, CLEAR ONLY

### TRIO HEX BOWLS

THIS TRIO HEX BOWL IS PERFECT FOR LIGHT SNACKS, CONDIMENTS, OR WHATEVER SUITS YOUR TABLETOP NEEDS. IT IS MADE FROM ALUMINUM AND CAN BE PURCHASED IN GOLD OR SILVER.



BWL-7020G GOLD  
BWL-7020S SILVER



### PEBBLE BOWLS (POLYCARBONATE)

SCRATCH RESISTANT, HEAT AND HIGH IMPACT RESISTANT. DISHWASHER SAFE. NSF LISTED. TEMPERATURE RANGE: -40.00°F - 212.00°F.

SB-721507	16" DIA. x 4.75" H.	2.75 GAL. (11 QT.)
SB-721807	19" DIA. x 5.62" H.	4.5 GAL. (18 QT.)
SB-722307	24" DIA. x 7.37" H.	8.25 GAL. (33 QT.)



### SERVING BOWL, COLDMASTER® (ABS PLASTIC)

WHITE COLD BOWL IS PERFECT FOR BUFFETS AND FOOD BARS AS KEEPS FOOD AT OR BELOW 40 DEGREE F FOR UP TO 5 HRS. NSF CERTIFIED.

AC-174 12 QT.



### LARGE BOWL (WHITE MELAMINE)

THE BOWL IS MADE OF NEARLY INDESTRUCTIBLE MELAMINE FOR LONG-LASTING USAGE. NOT RECOMMENDED FOR MICROWAVE USE. SOLD IN CASE PACKS OF 3.

BWL-225 25 QT. 24" DIA. X 6" H.



### SERVING BOWLS (PLASTIC)

DD-700	5 OZ. CLEAR	PKG/12
DD-701	5 OZ. BLUE	PKG/12
DD-702	5 OZ. BLACK	PKG/12
DD-703	5 OZ. PURPLES	PKG/12



### PEBBLE BOWLS (POLYCARBONATE)

THEY ARE HIGH IMPACT AND HIGH TEMPERATURE RESISTANT, DISHWASHER SAFE! NSF LISTED.

BWL-1500	6 3/4" DIA. ROUND
BWL-1501	8 3/4" DIA. ROUND
BWL-1502	10 3/4" DIA. ROUND
BWL-1503	12 3/4" DIA. ROUND
BWL-1504	15 3/4" DIA. ROUND
BWL-1505	18 3/4" DIA. ROUND



### ARCADE BOWL SERVING BOWLS (GLASS)

ARCADE BOWLS HAVE SCALLOPED EDGES THAT WILL GIVE A GREAT LOOK TO ANY TABLETOP! EACH ONE IS MADE OF FULLY TEMPERED GLASS WHICH EXTENDS THE LIFE OF THE BOWL SOLD IN CASE PACKS ONLY.

GL-43827	5" DIA.	11OZ.	CASE PACK 12 DOZ.
GL-43828	6" DIA.	22 OZ.	3 DOZ.
GL-43829	7" DIA.	38 OZ.	2 DOZ.
GL-43831	9" DIA.	72 OZ.	1 DOZ.



### STACK BOWLS (GLASS)

SOLD IN CASE PACKS ONLY.

GL-14222	2 1/3" DIA.	1 1/4 OZ.	CASE PACK 3 DOZ.
GL-14223	3" DIA.	2 3/4 OZ.	3 DOZ.
GL-14224	3 1/2" DIA.	5 OZ.	3 DOZ.
GL-14225	4 1/8" DIA.	7 1/2 OZ.	3 DOZ.
GL-14226	4 3/4" DIA.	12 OZ.	3 DOZ.
GL-14228	5 1/2" DIA.	21 OZ.	2 DOZ.
GL-14229	8" DIA.	64 OZ.	6 EACH
GL-14231	10 1/4" DIA.	144 OZ.	6 EACH

### GLASS BOWLS

SOLD IN CASE PACKS ONLY!



CHI-6100	6 3/4" D. X 2" H.	23 OZ.	CASE PACK 2 DOZ.
CHI-6101	8 1/4" D. X 3 3/4" H.	62 OZ.	1 DOZ.



### GLACIER BLUE BOWLS (GLASS)

DISHWASHER SAFE.

GLA-514	15" DIA. x 3" DEEP, 98 OZ.
GLA-515	18.5" DIA. x 3.5" DEEP, 128 OZ.



### ALL PURPOSE BOWLS (STAINLESS)

MIRROR FINISHED, GADROON TOP.

BWL-6495	24 OZ.	5" DIA., 3.25" H.
BWL-6496	40 OZ.	7" DIA., 3.25" H.



### GALVANIZED STEEL BOWLS WITH GOLD BEAD EDGE

SOLD IN CASE PACKS ONLY.

BWL-5470	11.5" X 3.25" H	CASE PACK 16 EACH
BWL-5471	16" X 4.5" H	16 EACH



### BOWLS (STAINLESS)

HAMMERED STYLE.

BWL-8500	OVAL FRUIT BOWL	13.5" x 7" x 3"
BWL-8510	BARTON BOWL	14.5" x 11"
BWL-8511	BARTON BOWL	11.5" x 8"
BWL-8520	MIDDLETON BOWL	6"
BWL-8531	SQUARE BOWL DOUBLE WALL	10"
BWL-8540	OVAL SERVE & DIP TRAY	15" x 11"
BWL-8541	ROUND SERVE & DIP TRAY	13"

# BOWLS



**DOUBLE WALL CONSTRUCTION INSULATED BEEHIVE STYLE BOWLS (STAINLESS)**  
MIRROR FINISH EXTERIOR, SATIN FINISH INTERIOR.  
DISHWASHER SAFE.

BWL-161	0.75 QT.	5 11/16" DIA. TOP x 3" HT.
BWL-162	1.7 QT.	7" DIA. TOP x 4" HT.
BWL-163	3.4 QT.	9" DIA. TOP x 5" HT.
BWL-164	6.9 QT.	11 13/16" DIA. TOP x 6 1/2" HT.



**DOUBLE WALL CONSTRUCTION INSULATED BEEHIVE BOWLS (STAINLESS)**

BWL-4719	3/4 QT.	5 1/2" SQ. x 2 3/4" H.
BWL-4732	1.8 QT.	7 5/16" SQ. x 3 1/2" H.
BWL-4734	3.2 QT.	8 5/8" SQ. x 4 1/4" H.
BWL-4735	5.2 QT.	9 5/8" SQ. x 5 3/16" H.
BWL-4737	8.2 QT.	11 13/16" SQ. x 5 15/16" H.



**DOUBLE WALL CONSTRUCTION INSULATED TRUMPET BOWL (STAINLESS)**

BWL-4664	3.4 QT., 9 5/8" DIA. x 5.5" HT.
----------	---------------------------------

**DOUBLE WALL BALI HAMMERED FINISH BOWL (HIGH POLISH STAINLESS STEEL)**

BWL-1384  
19" x 5.75" ROUND



**DOUBLE WALL CONSTRUCTION INSULATED SQUARE PLAIN STYLE BOWLS (STAINLESS)**

BWL-4771	0.75 QT.	5 1/2" SQ. x 2 3/4" H.
BWL-4772	1.8 QT.	7 1/4" SQ. x 3 7/16" H.
BWL-4774	3.2 QT.	8 1/2" SQ. x 4 1/4" H.
BWL-4775	5.2 QT.	10 3/16" SQ. x 5 1/8" H.
BWL-4777	8.3 QT.	11 13/16" SQ. x 5 15/16" H.



**DOUBLE WALL CONSTRUCTION INSULATED ANGLED BEEHIVE BOWLS (STAINLESS)**

BWL-182	1 QT.	7 3/8" DIA. x 5 1/2" H.
BWL-183	1.9 QT.	9 7/16" DIA. x 6 13/16" H.
BWL-184	3.7 QT.	11 13/16" DIA. x 8 1/4" H.
BWL-185	5 QT.	13 3/4" DIA. x 9 3/8" H.



**DOUBLE WALL CONSTRUCTION INSULATED ROUND BOWLS (SATIN FINISH STAINLESS STEEL)**

BWL-7500	4.75" DIA. x 2.5" H.	17 OZ.
BWL-7501	6" DIA. x 3" H.	34 OZ.
BWL-7502	10" DIA. x 4" H.	156 OZ.
BWL-7503	14" DIA. x 5" H.	338 OZ.



**DOUBLE WALL HAMMERED BOWLS (STAINLESS STEEL) DOUBLE WALL INSULATED, HAMMERED FINISH.**

BWL-14	250 OZ.	14 3/8" DIA. x 3 3/4" H.
BWL-19	657 OZ.	19" DIA. x 5 1/2" H.



**DOUBLE WALL CONSTRUCTION INSULATED ANGLE INSULATED BOWLS (18/8 STAINLESS)**

BWL-5406	23 OZ.	3 1/2" H. x 6" DIA.
BWL-5408	54 OZ.	3 7/8" H. x 8" DIA.
BWL-5410	108 OZ.	5" H. x 10" DIA.
BWL-5412	216 OZ.	6" H. x 12" DIA.
BWL-5414	360 OZ.	6 7/16" H. x 13 7/8" DIA.

**SQUARE BOWL (HAMMERED FINISH STAINLESS)**

BWL-67856	6" SQ.
BWL-67858	8" SQ.
BWL-67851	10" SQ.



**DOUBLE WALL CONSTRUCTION INSULATED BOWL (STAINLESS)**

BWL-4768	5 QT., 13.75" DIA. x 9 3/8" H.
----------	--------------------------------



**DOUBLE WALL ANGLED BOWLS (STAINLESS)**

BWL-5570	1.5 QT.	8.3" DIA. x 4.5" H.
BWL-5571	2.5 QT.	9" DIA. x 5.3" H.

**DOUBLE WALL CONSTRUCTION INSULATED REMINGTON SALAD BOWL (STAINLESS)**



BWL-72585  
12" DIA. x 4.5" H.



**BOWL (STAINLESS STEEL)**

BWL-6780  
5 QUARTS/4.7 LITERS  
4 7/8" HEIGHT



**COLORED DOUBLE WALL INSULATED SERVING BOWLS**

- COLORS: DAZZLE RED, COBALT BLUE, GREEN APPLE, NUGGET YELLOW, PEARL WHITE, FIRE ENGINE RED, BLACK, PASSION PURPLE. - STAINLESS STEEL WITH BEEHIVE LINED TEXTURE  
- DURABLE COLORED FINISH  
- SATIN INTERIOR FINISH  
- SOLD IN CASE PACKS ONLY!

BWL-4761910	0.75 QT.	5 1/2" SQUARE x 2 3/4" H.	<b>CASE PACK</b>
BWL-4763210	1.8 QT.	7 1/4" SQUARE x 3 7/16" H.	<b>6 EACH</b>
BWL-4763410	3.2 QT.	8 1/2" SQUARE x 4 1/4" H.	<b>12 EACH</b>
BWL-4763510	5.2 QT.	10 3/16" SQUARE x 5 1/8" H.	<b>6 EACH</b>
BWL-4763710	8.2 QT.	11 13/16" SQUARE x 5 15/16" H.	<b>4 EACH</b>
BWL-4658710	0.75 QT.	5 11/16" DIA. ROUND x 3" H.	<b>3 EACH</b>
BWL-4659010	1.7 QT.	7 1/4" DIA. ROUND x 4" H.	<b>6 EACH</b>
BWL-4659110	3.4 QT.	9 1/2" DIA. ROUND x 5" H.	<b>6 EACH</b>
BWL-4659210	6.9 QT.	11 13/16" DIA. ROUND x 6.5" H.	<b>3 EACH</b>
BWL-4656910	10.1 QT.	13 3/4" DIA. ROUND x 6 7/8" H.	<b>2 EACH</b>

**DOUBLE WALL CONSTRUCTION INSULATED CONICAL BOWLS (STAINLESS)**

BWL-4755	0.62 QT.	6 5/16" DIA. x 2.75" H.
BWL-4756	1.4 QT.	7.75" DIA. x 3.5" H.
BWL-4757	2.5 QT.	9 13/32" DIA. x 4.25" H.
BWL-4758	2.8 QT.	11" DIA. x 3 7/8" H.
BWL-4759	6.4 QT.	11" DIA. x 7.75" H.
BWL-4760	1.7 QT.	13" DIA. x 2" H.



**BOLT HAMMERED BOWL (STAINLESS STEEL)**

BWL-72590	4.25" H. x 11.5" DIA. BOWL, DOUBLE WALL
BWL-72591	10" TRIANGULAR BOWL



**SERVING BOWLS, ANGLED BOTTOM, DOUBLE WALL (HAMMERED FINISH STAINLESS STEEL)**



BWL-8110	6" DIA.
BWL-8111	8" DIA.
BWL-8112	10" DIA.
BWL-8113	12" DIA.



**NEW!**

**GOLD & WHITE BETHANY BOWLS**

HAMMERED GOLD ON THE OUTSIDE AND WHITE ON THE INSIDE.

BWL-7010	SMALL: 6.75" X 4" X 2.75" H.
BWL-7011	MEDIUM: 8.5" X 5.5" X 3.75" H.
BWL-7012	LARGE: 10" X 6.5" X 4.25" H.

# BOWLS



**PAUL REVERE BOWLS (STAINLESS)**  
HIGH POLISHED! DISHWASHER SAFE!  
AVAILABLE IN SILVERPLATE AND GOLDPLATE.

RB-1440	4" DIA.	8 OZ.
RB-1442	6" DIA.	20 OZ.
RB-1443	8" DIA.	48 OZ. (1.5 QT.)
RB-1444	10" DIA.	96 OZ. (3 QT.)
RB-1445	12" DIA.	160 OZ. (5 QT.)



**PAUL REVERE BOWLS (NON TARNISH SILVERTONE)**  
THEY ARE NON TARNISH AND DO NOT COME WITH A LINER. ENGRAVABLE.

RB-800	4" DIA.
RB-801	6" DIA.
RB-802	8" DIA.
RB-803	10" DIA.



**HAMMERED PUNCH BOWLS (18/8 STAINLESS)**  
INDIVIDUALLY CRAFTED WITH A BALL-PEEN HAMMER, BEADED EDGE.

PB-508	2 GAL.
PB-509	3.25 GAL.



**PUNCH BOWLS (POLYCARBONATE)**  
STRONG EXTERIOR, SCRATCH RESISTANT.

PB-45600	11.2 QT.	15" DIA.
PB-45601	20.2 QT.	18" DIA.
PB-45602	40 QT.	23" DIA.



**PUNCH BOWL (STAINLESS)**  
THE OUTSIDE AND TOP RIM ARE MIRROR FINISHED WHILE THE INTERIOR IS SATIN FINISHED FOR LONGER LIFE.

PB-82146	4.5 GAL., 18" DIA. x 9 13/16" H.
----------	----------------------------------



**PUNCH BOWLS (STAINLESS STEEL)**  
PB-72621 3 GAL., 15" DIA.



**PUNCH BOWL (STAINLESS)**  
PB-72620 15" DIA., 3 GAL.



**PUNCH BOWLS (18/8 STAINLESS)**  
ACSS-6658 2.5 GAL., 15.5" DIA.



**SOPRANO PUNCH BOWL (18/10 STAINLESS)**  
PB-481 4 GAL., 16.7" W. x 8.2" BASE x 9.6" H.



**PUNCH BOWL (STAINLESS)**  
PB-35 3.5 GA., 14.37" L. X 14.37" W. X 9.65" H.



**DISPLAY BOWLS (18/10 STAINLESS)**  
MIRROR POLISHED FINISH. BALL FEET.

BWL-1617	20 OZ.	5 1/4" DIA.
BWL-1618	26 OZ.	5 7/8" DIA.
BWL-1619	48 OZ.	7" DIA.
BWL-1620	3 QT.	9 1/2" DIA.



**PUNCH BOWL (18/10 STAINLESS)**  
GOLD ACCENTED SIDE HANDLES. SOLD WITHOUT LADLE. BOWL ONLY!

PB-185	3.5 GALLON
--------	------------



**GLASS PUNCH BOWL (CRYSTAL)**  
LEAD FREE HANDMADE CRYSTAL. SOLD AS SET OF 4 EACH.

PB-1680	1.25 GALLON
---------	-------------



**HAMMERED PAUL REVERE BOWLS (STAINLESS STEEL)**

RB-750	6.75" DIA.
RB-751	8" DIA.
RB-752	10" DIA.
RB-753	11.75" DIA.



**PAUL REVERE BOWLS (SILVERPLATED)**  
MEDIUM WEIGHT, SILVERPLATED OVER STEEL.

RB-204	4" DIA.
RB-206	6" DIA.
RB-208	8" DIA.
RB-201	10" DIA.



**HAMMERED PUNCH BOWL (STAINLESS STEEL)**  
THIS STAINLESS STEEL DOUBLE WALL PUNCH BOWL HAS A UNIQUE HAMMERED DESIGN.

BWL-72600	3 GAL.
-----------	--------



**BOLT HAMMERED PUNCH BOWL (STAINLESS STEEL)**

PB-72596	3 GALLON, DOUBLE WALL
----------	-----------------------



**PUNCH BOWL (STAINLESS STEEL)**  
MIRROR FINISH.

PB-46072	5 GAL., 17" DIA. X 11 1/2" H.
----------	-------------------------------



**PUNCH BOWLS (STAINLESS STEEL)**  
PB-45 3 GAL., 15.75" DIA.



**ODESSA GOLD GLASS BOWLS**

GL-31200	6" DIA.
GL-31201	7.5" DIA.
GL-31202	12.5" DIA.



**PAUL REVERE BOWLS(SILVERPLATE)**

RB-54	4" DIA., 6 OZ.	BOWL
RB-541	4" DIA.	BOWL/LINER
RB-5411	4" DIA.	LINER
RB-55	6" DIA., 18 OZ.	BOWL
RB-551	6" DIA.	BOWL/LINER
RB-5511	6" DIA.	LINER
RB-56	8" DIA., 48 OZ.	BOWL
RB-561	8" DIA.	BOWL/LINER
RB-5611	8" DIA.	LINER
RB-58	10" DIA., 3 QT.	BOWL
RB-581	10" DIA.	BOWL/LINER
RB-5811	10" DIA.	LINER
RB-59	12" DIA., 1 GAL.	BOWL

**13 PIECE ROMANTICA COLLECTION PUNCH BOWL SET (SILVERPLATE)**

THIS SILVERPLATED 13 ROMANTICA PUNCH BOWL SET OFFERS A 3.5 QT. PUNCH BOWL (7" HIGH, OUTER DIAMETER OF THE RIM IS 13", INNER DIAMETER OF THE RIM IS 10"), TRAY, LADLE AND 10 PUNCH CUPS. THIS SET IS PERFECT FOR ADDING ELEGANCE TO YOUR ENTERTAINING.

RPB-8980	13 PC SET
----------	-----------



**10 PIC SET PUNCH BOWL WITH CUPS DUBLIN CUT CRYSTAL**

THIS CUT CRYSTAL PUNCH BOWL SET OFFERS A TWO GALLON PUNCH BOWL, LADLE, AND 8 PUNCH CUPS. THIS SET IS PERFECT FOR ADDING ELEGANCE TO YOUR ENTERTAINING AT ANY EVENT.

PB-25582	2 GAL., 12.5" DIA. X 10.5" H.
----------	-------------------------------



# ICE BUCKETS & WINE COOLERS

**ICE BUCKET (STAINLESS)**



ICE BUCKET HAS FLAT HANDLE, HINGED LID AND COMES COMPLETE WITH PERFORATED DRAIN TRAY AND TONG.  
WC-609190  
1.5 QT. x 3.5" H.  
4.87" DIA. BASE  
5.87" DIA. TOP

**ICE BUCKET (18/8 STAINLESS)**



ICE BUCKET HAS TUBULAR HANDLE AND SATIN FINISH, COMPLETE WITH LID. HAND WASH ONLY!  
WC-609193  
3.5 QT.

**DOUBLE WALL ICE BUCKET (STAINLESS STEEL)**



WC-76  
7" x 6" x 6.5"

**ICE BUCKET WITH TONGS (CHROMEPLATE)**



BUILT-IN TONG HOLDER. SOLD WITH TONG.  
WC-295  
44 OZ.  
6 11/16" DIA. x 8-7/8" H.

**ICE BUCKET WITH TONG (STAINLESS)**



IB-72587 1.5 QT.

**ICE BUCKET (18/8 STAINLESS)**  
MIRROR FINISH EXTERIOR, SATIN-FINISH INTERIOR, WELDED HANDLES.



ACSS-169 1.6 QT., 5 7/8" DIA. x 5 1/2" HT.

**DELUXE WINE COOLER (STAINLESS)**



WC-72586 8.25" x 8.75"

**CHAMPAGNE BUCKET (STAINLESS)**



WC-1571 11" DIA. X 7.5" TAL

**DOUBLE WALL ICE BUCKET (STAINLESS)**



WC-606 60 OZ., 6" L. x 6" W. x 6" H.

**HAMMERED DOUBLE WALL WINE COOLER (STAINLESS STEEL)**



WC-72609 9" DIA. x 9" H.

**FLUTED WINE BUCKET (18/8 STAINLESS)**



WC-7617 9.43" W. x 8.75" W. x 6 1/2" TOP DIA.

**WINE COOLER (STAINLESS)**



BEEHIVE STYLE, HEAVY GAUGE, MIRROR FINISH 18/8 STAINLESS STEEL, DISHWASHER SAFE.  
WC-167 7 7/8 HT. X 7.5" DIA."

**ICE BUCKETS WITH LID AND TONG (STAINLESS)**



MADE FROM STAINLESS STEEL WITH A SATIN FINISH. DOUBLE WALL DESIGN.  
IB-751 34 OZ. 4 7/8" DIA. X 6 3/8" H.  
IB-752 49 OZ. 4 3/8" DIA. X 8 1/4" H.

**ICE BUCKETS W/LID AND TONG (STAINLESS)**



MADE FROM STAINLESS STEEL WITH A SATIN FINISH. DOUBLE WALL DESIGN.  
4 3/8" DIA. X 6 1/4" H.

**VICTORIAN DOUBLE WALL WINE COOLER/ ICE BUCKET WITH TONGS (STAINLESS)**



WC-7501 8" H.



**ICE BUCKET WITH LID, DOUBLE WALL (18/8 STAINLESS STEEL)**  
WCS-750 3 LITER, 8.5" x 7.25" x 9"



**ICE BUCKET WITH TONGS (STAINLESS)**  
IB-72587 1.5 QT., 6" DIA. x 6.5" H.  
IB-72588 3 QT., 7.5" DIA. x 7.25" H.



**APPLE ICE BUCKET WITH TONG (STAINLESS)**  
MIRROR FINISH STAINLESS STEEL. TONGS ARE INCLUDED.  
ACSS-72410 1.25 QT. 6.5" H X 6.25" DIA.  
ACSS-72411 2 QT. 8" H. X 7.5" DIA.



**BRANDYWINE (STAINLESS)**  
ITEMS ARE MIRROR FINISH STAINLESS STEEL.  
ACSS-72500 2 QT, 6" DIA. x 6.25" H., ICE BUCKET W/ TONGS  
ACSS-72501 5.25 QT, 6" DIA. x 9.25" H., WINE COOLER



**DOUBLE WALL ICE BUCKET WITH HANDLE & COVER & TONGS (STAINLESS)**  
HAMMERED FINISHED.  
WC-72607 6" H. x 6" DIA.

**BOLT HAMMERED FINISH DOUBLE WALL ICE BUCKETS (STAINLESS)**

WC-72595 8" DIA., ICE BUCKET WITH LID & TONG  
WC-72599 6" H., ICE BUCKET WITH LID TONG



WC-72595

WC-72599

**GOLDEN VINE HAMMERED COLLECTION (STAINLESS STEEL)**

WC-7388 11" H. WINE BUCKET  
WC-7392 16" DIA. x 6.25" H. ICE BUCKET



BWL-7392



WC-7388



**STAINLESS STEEL COVERED ICE BUCKET WITH TONG**  
THE BUCKET HAS AN INSULATED LINER TO KEEP THE ICE FROM MELTING TOO FAST. THE REMOVEABLE COVER HAS A KNOB STYLE THAT MATCHES THE SIDE HANDLES. IT INCLUDES A TONG THAT IS 4.75" LONG.

WCSS-2090 5.75" DIA X 6.5" H.

# ICE BUCKETS, PARTY TUBS, & WINE COOLERS



**WINE COOLER (SILVERPLATE)**  
WC-292 9" DIA. x 9.75" HT.



**GADROON WINE COOLER (SILVERPLATE)**  
WC-293 9" DIA. x 9.75" HT.



**GADROON BORDER WINE COOLER (SILVERPLATE)**  
WC-296 5.5" DIA BASE RIM X 10.25" H.



**WINE COOLERS (BRUSHED STAINLESS STEEL)**  
DOUBLE WALL INSULATION KEEPS WINE CHILLED FOR UP TO 4 HOURS.

- WC-555 UPRIGHT 4-3/4" DIA. X 7-5/8" H.
- WC-911 UPRIGHT 8" H. x 5.25" W.
- WC-912 SLANTED 9.25" H. x 5.25" W.



**DOUBLE WALL WINE COOLER (STAINLESS STEEL)**  
WC-570 5" DIA. X 8" H.



**MARBLE WINE COOLERS**  
WC-857 WHITE, 5" DIA. x 7" H.  
WC-859 BLACK, 5" DIA. x 7" H.



**DOUBLE WALL HOURGLASS WINE COOLER (18/8 STAINLESS)**  
MIRROR FINISHED EXTERIOR, SATIN FINISHED INTERIOR.  
WC-4766 5.75" DIA. x 8.5" H.



**DOUBLE WALL BEEHIVE WINE COOLERS (18/8 STAINLESS)**  
MIRROR FINISHED EXTERIOR, SATIN FINISHED INTERIOR.  
WC-47615 4.5" DIA. x 7 7/8" H.



**HAMMERED FINISH WINE COOLER & WINE BUCKET**  
WC-564 STAINLESS STEEL WINE COOLER 4.75" D. x 7.25" H.  
WC-600 COPPERPLATED WINE 4 3/4" DIA. x 7 1/4" H.  
WC-601 COPPERPLATED ICE BUCKET 9 3/8" L. x 8" W. x 8 3/8" H.



**REMINGTON COLLECTION™ (18/8 STAINLESS)**  
RICE PATTERN. HIGH POLISH STAINLESS STEEL.

- WC-110 6 GAL., 16.5" x 9.5" ROUND BEVERAGE TUB WITH BASE
- WC-115 8.75 GAL., 20.5" x 11" ROUND BEVERAGE TUB WITH BASE
- WC-120 6.75 GAL., 19" x 9" ROUND BEVERAGE TUB, SATIN FINISH.
- WC-125 6 GALLON, 23.5" x 13.75" x 9" OVAL BEVERAGE TUB

WC-110, WC-115



WC-120



**BALI COLLECTION**  
HIGH POLISH STAINLESS STEEL WITH A HAMMERED FINISH.

BT-2013 BEVERAGE TUB, 4 GAL., 20.5" x 13.5" x 8.75" OVAL

BT-1815 DOUBLE WALL BEVERAGE TUB 5.7 GAL., 18" x 15.25" x 8.75" OVAL



**LINES DESIGN ICE BUCKET, COCKTAIL SHAKER, PITCHER, WINE COOLER (STAINLESS)**

- WC-72701 ICE BUCKET WITH LID AND TONG, 6" DIA., DOUBLE WALL
- WC-72704 COCKTAIL SHAKER, 22 OZ.
- WC-72706 WINE COOLER, 8" H. x 4.5" DIA., DOUBLE WALL
- WC-72708 ICE BUCKET, 9" DIA., DOUBLE WALL
- WC-72709 WATER PITCHER, 52 OZ.



**HAMMERED DESIGN ICE BUCKET & PARTY TUB (STAINLESS STEEL)**

- BT-4800 19" DIA. x 11" H.
- BT-72623 20.5" L. X 14" W. X 9" H.
- WC-8010 3 QT., 7.25" DIA. x 7" H.
- ROUND DOUBLE WALL PARTY TUB
- OVAL BEVERAGE TUB
- ICE BUCKET W/TONG

WC-8010

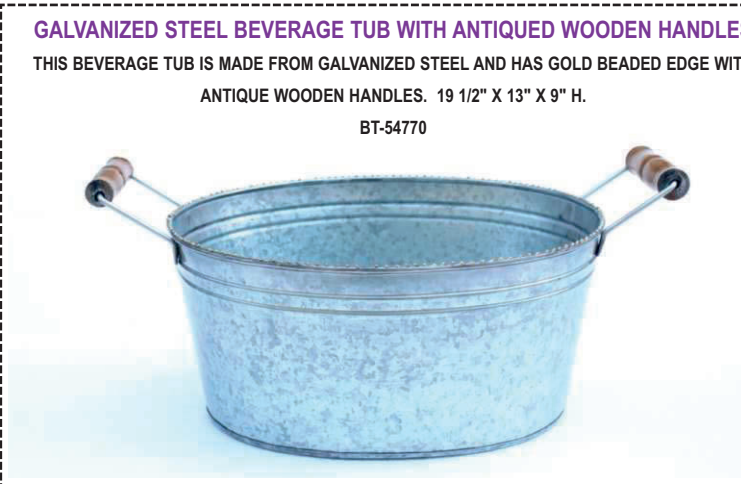

**GALVANIZED STEEL BEVERAGE TUB WITH ANTIQUED WOODEN HANDLES**  
THIS BEVERAGE TUB IS MADE FROM GALVANIZED STEEL AND HAS GOLD BEADED EDGE WITH ANTIQUE WOODEN HANDLES. 19 1/2" X 13" X 9" H.

BT-54770



**PARTY TUB (18/8 STAINLESS HAMMERED)**  
THIS BIG PARTY TUB IS INDIVIDUALLY CRAFTED WITH A BALL-PEEN HAMMER. NO TWO PIECES ARE EXACTLY THE SAME.  
WC-676  
13.5" HT. x 9" D. x 19.5" L.

# ICE BUCKETS, PARTY TUBS, & WINE COOLERS



**SOPRANO WINE COOLER & STAND (18/10 STAINLESS)**  
EACH ITEM SOLD SEPARATELY.  
WC-471  
9 7/8" DIA. x 8 1/2" H. WINE COOLER  
WCS-471  
12.4" L. x 19.5" W. x 13" H. WINE COOLER STAND



**WINE BUCKET AND STAND (STAINLESS)**  
SOLD IN CASE PACKS OF 4.  
WC-4205  
8 QT., 8 3/4" DIA., 9 7/8" H. WINE BUCKET  
WCS-4206  
29.4" H. WINE BUCKET STAND  
EACH ITEM SOLD SEPARATELY.



**WINE BUCKET AND STAND (STAINLESS STEEL)**  
MIRROR FINISH WINE BUCKET, PIPE STYLE STAND.  
EACH ITEM SOLD SEPARATELY.  
WC-8520 4 QT., 8" DIA. x 10" H. WINE BUCKET FITS WCS-8521  
WCS-8521  
28.5" WINE STAND HOLDS WC-852



**HAMMERED WINE BUCKET (STAINLESS STEEL)**  
HAMMERED STAINLESS STEEL WINE BUCKET. FITS WCS-562 AND WCS-507. ITEMS SOLD SEPARATELY.  
WC-563 9-3/8" L. X 8" W. X 8-3/8" H. WINE BUCKET  
**CHAMPAGNE STAND (WROUGHT IRON)**  
HAMMERED WINE BUCKET. FITS WC-563. ITEMS SOLD SEPARATELY.  
WCS-562 CHAMPAGNE STAND  
**WINE BUCKET STAND (STAINLESS STEEL)**  
FITS WC-563. NON-TARNISH. ITEMS SOLD SEPARATELY.  
WCS-507 24" WINE BUCKET STAND



**DOUBLE WINE BUCKETS AND STANDS (18/10 STAINLESS)**  
A HEAVY DUTY 18/10 MIRROR FINISH STAINLESS STEEL. OUTSIDE AND A SATIN FINISH INSIDE FOR LONGEVITY. WINE BUCKET STAND SHIPPED KNOCKED DOWN  
WC-1435 8 1/4" DIA. x 8" HT. SINGLE BOTTLE  
WCS-1436 7 3/4" DIA. x 23 5/8" HT. SINGLE BOTTLE STAND FITS WC-1435  
WC-1437 9 7/8" DIA. x 9 1/8" HT. DOUBLE BOTTLE  
WCS-1438 8 5/8" DIA. x 23 5/8" HT. WINE COOLER STAND FITS WC-1437



**NATURAL GALVANIZED TUBS**  
NATURAL GALVANIZED TUBS ARE PERFECT FOR ANY CATERED EVENT! SMALLER SIZES CAN BE USED FOR SANDWICHES AND SNACKS, WHILE THE LARGER SIZES ARE PERFECT FOR CANS AND BOTTLE OF SOFT DRINKS, WINE OR ALCOHOL. IT SHOULD NOT BE USED TO SERVE ACIDIC FOOD OR CLEANED WITH ACIDIC SUBSTANCES. IT SHOULD BE HAND WASHED ONLY.

WC-170	27 OZ., 6" DIA. x 3" H.	ROUND TUB
WC-171	37 OZ., 8" DIA. x 3" H.	ROUND TUB
WC-172	54 OZ., 10" DIA. x 3" H.	ROUND TUB
WC-173	95 OZ., 12" DIA. x 3" H.	ROUND TUB
WC-174	24 OZ., 9" L. x 6" W. x 2 1/4" H.	OVAL TUB
WC-175	25 QT., 20" L. x 15" W. x 11" H.	OVAL TUB
WC-176	148 OZ., 1.16 GAL., 8" DIA. x 7" H.	ROUND PAIL

**ROUND BEVERAGE TUB**  
**OVAL BEVERAGE TUB**

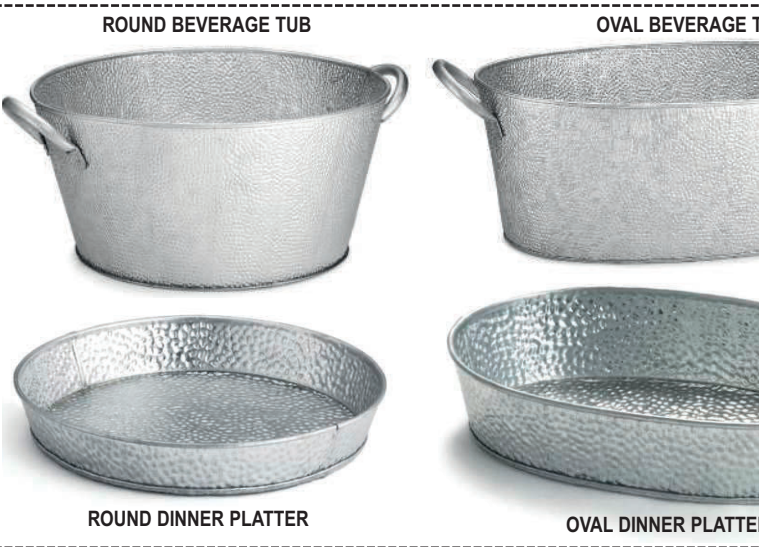

**ROUND DINNER PLATTER**  
**OVAL DINNER PLATTER**

**GALVANIZED COLLECTION**

- PEBBLED TEXTURE
- HAND WAS RECOMMENDED
- SOLD IN CASE PACKS ONLY

ITEM	SIZE	DESCRIPTION	CASE PACK
BT-98500	18.5" x 15" x 7"	ROUND BEVERAGE TUB	1 EACH
BT-98501	15" x 19" x 7.5"	OVAL BEVERAGE TUB	1 EACH
BT-98502	23" x 13" x 7.5"	OVAL BEVERAGE TUB	1 EACH
PLT-98503	8.5" DIA.	ROUND DINNER PLATTER	12 EACH
PLT-98504	10.5" DIA.	ROUND DINNER PLATTER	12 EACH
PLT-98505	12" DIA.	ROUND DINNER PLATTER	12 EACH
PLT-98506	9.5" x 6"	OVAL DINNER PLATTER	12 EACH
PLT-98507	12" x 9"	OVAL DINNER PLATTER	12 EACH
PL-98508	3" x 3"	ROUND PAIL WITH HANDLE	12 EACH
PL-98509	4" x 4"	ROUND PAIL WITH HANDLE	12 EACH
PL-98510	8" x 7"	ROUND PAIL WITH HANDLE	4 EACH



**HAMMERED FINISH DOUBLE WALL PARTY TUB (STAINLESS STEEL)**  
PT-72622  
16" D. x 10" H.



**SQUARE TUBS (HAMMERED STAINLESS STEEL)**  
DISHWASHER SAFE.  
**NEW!**  
SPT-600 1 3/8 QT. 6" SQ. X 3 1/4" H.  
SPT-601 6 1/4 QT. 8" SQ. X 7 1/4" H.  
SPT-602 22 1/4 QT. 14" SQ. X 8 1/2" H.  
SPT-603 32 1/2 QT. 16 1/2" SQ. X 9 1/2" H.



**DOUBLE-WALL BEVERAGE TUB WITH 6 BOTTLE LID (STAINLESS STEEL)**  
THIS TUB CAN BE USED WITH OR WITHOUT THE LID. MIRROR FINISH.  
BT-72445 15.75" DIA. x 9.5" H.



**WINE BUCKET (COPPERPLATED)**  
THIS COPPERPLATE OVER STAINLESS STEEL WINE BUCKET WILL STANDOUT AT ANY BAR, CATERING EVENT, HOTEL, OR RESTAURANT. EACH PIECE OFFERS YOUR EVENT TO HAVE SERVICE IN STYLE.  
**NEW!**  
ACC-2505  
4 QT., 8.5" DIA. X 8" H.

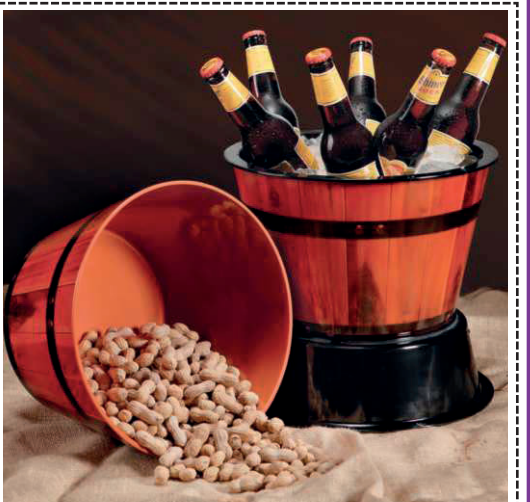

**MELAMINE BARRELS (MELAMINE)**  
INCLUDING SOLID AND SLOTTED INSERTS AND A LID. PERFECT FOR BAKERIES, RESTAURANTS AND CAFES!  
MUST BUY IN SET OF 3.  
BA-27100 2.6 GAL., 12" DIA. X 7.88" H. BUCKET  
IN-27101 1.7 GAL., 12.75" DIA X 3.75" DEEP SOLID INSERT  
IN-27102 12.75" DIA X 3.75" DEEP SLOTTED INSERT  
LID-27103 CLEAR LID



# BAR SUPPLIES & CHILLERS



**ICE HOUSINGS WITH INSERT PAN (STAINLESS STEEL)**  
DECORATIVE STAINLESS STEEL COLD BOWL. HOUSING SOLD WITH CLEAR POLYCARBONATE PAN INSERT.

- AC-6180 ICE HOUSING WITH INSERT PAN, 6" W. x 7" D. X 6 1/2" H.
- AC-6181 ICE HOUSING WITH INSERT PAN 110" W. x 12" D. X 6 1/2" H.
- AC-6182 ICE HOUSING WITH INSERT PAN, 12" W. x 20" D. X 6 1/2" H.
- AC-6184 STAINLESS STEEL 2 TIER HOUSING RISER, 1/6 SIZE FRAME FOR AC-6180 15" L. x 7" W. x 13" H.



**DOUBLE WALL CHILLERS (STAINLESS STEEL)**

THESE SENSATIONAL CHILLERS SPARK A DRAMATIC LOOK WHEREVER THEY'RE PLACED. KEEP BOTTLES CHILLED FOR UP TO 4 HOURS.

- WC-8750 5 1/4" L x 5 1/4" W, x 8" H. 90 OZ. HOLD 1 BOTTLE
- WC-8751 10" L. x 6 3/4" W. x 8" H. 285 OZ. HOLD 2 BOTTLE
- WC-8752 18 1/2" L. x 6 3/4" x 8" H. 400 OZ. HOLD 4 BOTTLE



**DESIGNER TOTE BOX FRAME (STAINLESS)**

TOTE BOX FRAME FITS OVER BUS BOXES. FOLDS FLAT, NO BOTTOM.

TB-1535 22" x 16" x 8"



**INSULATED BIN**

DUAL BIN INSULATED ICER. LARGE CAPACITY MADE OF DURABLE ABS RESIN. EACH BIN IS 21.5" x 21.5" x 3.5" D. CAN ONLY BE SHIPPED BY TRUCK.

BN-1285 48" W. x 25 1/2" D. x 6" H.



**24" LIGHTED BOTTLE STAIR (ACRYLIC)**

HIGHLIGHT YOUR SPIRITS AND FINE WINES WITH THIS THREE-STEP, LIGHTED BOTTLE DISPLAY. AT 24" WIDE, THIS DISPLAY EASILY ACCOMMODATES 21 - 3" TO 4" DIAMETER BOTTLES. MADE OF BLACK ACRYLIC WITH TRANSLUCENT STAIRS. INLINE SWITCH FOR EASY ON AND OFF.

STR-450 13" H. x 24" W. x 12.5" D.



**CONDIMENT HOLDERS (STAINLESS STEEL BASE, DURABLE PLASTIC CONSTRUCTION INSERT)**

- AC-1420 4 COMPARTMENT 12" L. x 6.5" W. x 4" H.
- AC-1421 5 COMPARTMENT 15.4" L. x 6.6" W. x 4" H.
- AC-1422 6 COMPARTMENT 18" L. x 6" W. x 4" H.
- AC-1423 1 PINT INSERT ONLY 5.6" L. x 2.9" W. x 2.9" H. PKG/ 1 DOZ.
- AC-1424 1 QUART INSERT ONLY 5.6" L. x 2.9" W. x 2.9" H. PKG 1 DOZ.



**BAR MAT**

THIS BAR MATS MEASURE 27" BY 3.25". GREAT FOR REDUCING SLIPPING OF GLASSES AND BOTTLES. A BAR MUST!

AC-1418 BROWN, 27" x 3.25"



**BAR LINER (SOFT PLASTIC)**  
2' WIDE BY 40' LONG ROLL. BPA FREE.

- BL-100 CLEAR 2' WIDE x 40' LONG
- BL-101 GREEN 2' WIDE x 40' LONG
- BL-102 BLACK 2' WIDE x 40' LONG
- BL-103 RED 2' WIDE x 40' LONG
- BL-104 WHITE 2' WIDE x 40' LONG



**GLASS RIMMERS (ACRYLIC)**

UNIT ALLOWS FOR APPLICATION OF EITHER SALT OR SUGAR ON RIMS OF GLASSES.

- AC-1799 2-TIER, 7.87" L. x 6.25" DIA. x 1.95" H.
- AC-1828 3-TIER, 7.87" L. x 6.25" DIA. x 2.95" H.



**STOR 'N POUR® (POLYETHYLENE)**

STORE 'N POUR COMPLETE UNITS AND BACKUPS. COMPLETE UNIT INCLUDES NECK AND CONTAINER PLUS COLOR-COORDINATED POURING SPOUT AND CAP. BACKUP UNIT INCLUDES CAP AND CONTAINER IN ASSORTED COLORS. AVAILABLE IN BROWN, GREEN, ORANGE, RED, YELLOW, AND WHITE (WITH CLEAR SPOUT). PINT AND QUART ASSORTED PACKS INCLUDE TWO EACH OF THE ABOVE COLORS. HALF GALLON AND GALLON ASSORTED PACKS INCLUDE ONE OF EACH OF THE ABOVE COLORS. ASSORTED PACK SENT IF NO COLOR SPECIFIED.

- AC-1784 PINT COMPLETE W/ NECK, CONTAINER, AND COLOR-COORDINATED CAP
- AC-1785 PINT BACKUP W/ CONTAINER AND CAP
- AC-1788 HALF-GALLON COMPLETE W/ NECK, AND COLOR-COORDINATED CONTAINER
- AC-1789 HALF-GALLON BACKUP W/ CONTAINER AND CAP
- AC-1790 GALLON COMPLETE W/ NECK, AND COLOR-COORDINATED CONTAINER
- AC-1791 GALLON BACKUP W/ CONTAINER AND CAP
- AC-1793 SPOUT ONLY, COLORS: BROWN (01), CLEAR (07), GREEN (09), ORANGE (24), RED (05), YELLOW (04)
- AC-1794 NECK ONLY, WHITE COLOR ONLY
- AC-1795 CAP ONLY, GREEN (09), ORANGE (24), RED (05), WHITE (02), YELLOW (04)
- AC-1796 QUART CONTAINER ONLY, WHITE COLOR ONLY

- SPEED RAILS (STAINLESS)**  
MOUNTING STRAPS SOLD SEPARATELY
- AC-1483 22" SINGLE 22" L. x 4.1" W. x 6.2" H.
  - AC-1484 22" DOUBLE 22" L. x 4.1" W. x 9.5" H.
  - AC-1485 32" SINGLE 32" L. x 4.1" W. x 6.2" H.
  - AC-1486 32" DOUBLE 32" L. x 4.1" W. x 9.5" H.
  - AC-1487 42" SINGLE 42" L. x 4.1" W. x 6.2" H.
  - AC-1489 42" DOUBLE 42" L. x 4.1" W. x 9.5" H.
  - AC-1490 MOUNTING STRAPS FOR SPEED RAILS 7.5" L. x 1.5" W. x 1.8" H.

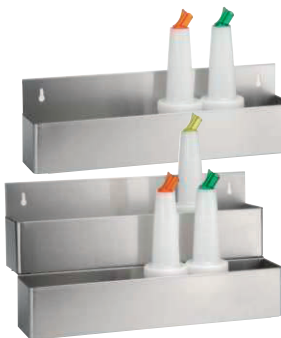

**ICE PORTER**

FEATURES DURABLE BREAK RESISTANT PLASTIC FOR LONG-LASTING USE, POUR SPOUT, BUILT IN, EASY GRIP HANDLE, BUILT IN HOOK FOR HANGING/DRAINING. 30 LB CAPACITY, LIGHT BLUE.

AC-1577 18" H. x 8 1/2" DIA.



**PORTION POURERS**

CLASSIC DESIGN PORTION POURERS DISPENSE EXACT SHOTS OF LIQUOR FROM 1/2 OZ TO 2 OZ. CLEAR SPOUT WITH BLACK COLLAR.

- PP-1831 1/2 OZ. ORANGE TAIL
- PP-1832 5/8 OZ. BLACK TAIL
- PP-1833 3/4 OZ. GREEN TAIL
- PP-1834 7/8 OZ. BLUE TAIL
- PP-1836 1 1/8 OZ. PURPLE TAIL
- PP-1837 1 1/4 OZ. CLEAR TAIL
- PP-1848 1 1/2 OZ. YELLOW TAIL
- PP-1849 2 OZ. WHITE TAIL



**BLACK BAR CADDY (PLASTIC)**

BREAK RESISTANT BLACK PLASTIC BAR CADDY.

AC-1798 9.5" L. x 6.06" W. x 4.15" H.



**BLACK ASHTRAY (PLASTIC)**

SOLD IN CASE PACKS OF 1 DOZEN. HEAT RESISTANT UP TO 380°F (193°C).

AC-4205 4" DIA.



**FREE FLOW POURERS**

POUR FREE FEATURES A SMALL, SLEEK NECK, AND ALLOWS FOR FREE-FLOW POURING. MUST BUYING CASE PACK ONE DOZEN.

- CASE PACK**
- PF-1841 RED 1 DOZ.
  - PF-1844 BLACK 1 DOZ.
  - PF-1845 CLEAR 1 DOZ.
  - PF-1847 GREEN 1 DOZ.
  - PF-1848 WHITE 1 DOZ.
  - PF-1849 YELLOW 1 DOZ.



**8 PC COCKTAIL KIT (STAINLESS)**

THIS KIT INCLUDES (1) OF THE FOLLOWING: 28 OZ SHAKER, 16 OZ SHAKER, 4-PRONG STRAINER, FLAT BOTTLE OPENER, WAITER'S CORKSCREW, 11" RED KNOB BAR SPOON, 9" ICE SCOOP, AND A JULEP STRAINER.

CK-1150 8 PC. COCKTAIL SET

# BAR SUPPLIES & COCKTAIL SHAKERS



**COASTERS (SILVERPLATE)**  
SOLD IN CASE PACKS OF SETS.  
AC-1049 6" DIA. ROUND SET/4  
AC-1043 4" DIA. ROUND SET/6



**HAMMERED COASTERS (STAINLESS STEEL)**  
SOLD IN CASE PACKS OF 4.  
AC-72688 4" DIA. ROUND



**COASTER (18/8 STAINLESS)**  
MIRROR FINISH.  
AC-168 6 1/8" DIA. ROUND



**WINE COASTER (SILVERPLATE)**  
SILVERPLATE WINE COASTER. WINE COASTER IS 5 INCH IN DIAMETER. PREVENTS BOTTLE DRIPPING.  
AC-4376 5" DIA.



**BLACK BEVERAGE DRIP TRAY /COASTER (PLASTIC)**  
FEATURES MOLDED PLASTIC ON NON-SKID SURFACE W/ RUBBER FEET MOUNTED TO BASE FOR FIRM HOLD.  
AC-1567 6" DIA.



**OCTAGON DRIP TRAY (PLASTIC)**  
MUST BUY IN CASE PACKS OF 12 EACH.  
RK-3546 6" x 6"



**CORKSCREW AND BOTTLE OPENER (STAINLESS)**  
AC-1588



**CAN & BOTTLE OPENERS (STAINLESS)**  
MUST BUY IN CASE PACKS OF DOZEN.  
AC-1294 CAN/BOTTLE OPENER  
AC-1295 CAN/BOTTLE OPENER  
AC-1296 CAN OPENER  
AC-1297 CAN OPENER  
WOOD HANDLE



**BAR SPOON (STAINLESS)**  
RED KNOB AND TWISTED HANDLE.  
AC-1298 11" LENGTH



**BAR STRAINER (STAINLESS)**  
AC-12933 4 PRONG



**LEMON/LIME SQUEEZER (STAINLESS)**  
MUST BUY IN CASE PACKS OF 6 EACH.  
JC-401 6.5" x 3" x 1.5"



**CORKSCREW OPENER (CHROMEPLATE)**  
HEAVY DUTY  
AC-1589  
10" x 4" x 3"



**JIGGERS (STAINLESS)**  
SOLD IN CASE PACKS OF 12.  
AC-1299 1/2 OZ. - 1 OZ.  
AC-1300 3/4 OZ. - 1 1/4 OZ.  
AC-1301 3/4 OZ. - 1 1/2 OZ.  
AC-1416 1 OZ. - 1 1/2 OZ.  
AC-1417 1 OZ. - 2 OZ.

**KNIVES (STAINLESS BLADE WITH WOOD HANDLE)**  
THE BLADE IS MADE FROM STAINLESS STEEL SO IT WILL NOT RUST. THE HANDLE IS MADE FROM DURABLE WOOD TO LAST.



**NEW!**

KNV-250 7.2" L. FORKED KNIFE  
KNV-251 6" L. TWISTER PEELER WITH ZESTER  
KNV-252 7" L. PARING KNIFE



**DRINKING STRAWS (18/8 STAINLESS STEEL)**  
THESE DRINKING STRAWS ARE MADE FROM 18/8 STAINLESS STEEL WHICH MAKES THEM REUSABLE AND ENVIRONMENTALLY FRIENDLY. EACH SET INCLUDES FOUR STRAWS AND ONE CLEANING BRUSH. THE STRAWS ARE RUST-RESISTANT, SCRATCH PROOF, AND DISHWASHER SAFE.

STR-1400 CURVED DRINKING STRAW  
STR-1401 STRAIGHT DRINKING STRAW

**NEW!**



**COPPER BARWARE (COPPERPLATED)**  
THIS COLLECTION OF COPPERPLATE OVER STAINLESS STEEL BARWARE WILL STANDOUT AT ANY BAR, CATERING EVENT, HOTEL, OR RESTAURANT.

ACC-2500 6" L. X 4.75" W. 4 PRONG STRAINER  
ACC-2501 7" L. SPEED OPENER  
ACC-2502 28 OZ. SHAKER.  
ACC-2503 8 OZ. 3 PIECE SHAKER  
ACC-2504 16 OZ. 3 PIECE SHAKER  
ACC-2506 1 OZ. AND 2 OZ. JIGGER  
ACC-2507 11.25" L. TWISTED HANDLE SPOON

**NEW!**



**HAMMERED TUMBLER (STAINLESS STEEL)**  
THIS HAMMERED TUMBLER IS DESIGNED LIKE A MEDIEVAL DRINKING CUP. IT IS A MULTI-PURPOSE CUP FOR DRINKING OR PRESENTATION OF AN APPETIZER OR DESSERT!

BRSS-1160  
12 OZ.  
3 1/4" DIA. X 4 1/4" H.



**DOUBLE WALL LINES COCKTAIL SHAKER (STAINLESS)**  
THE SHAKER HAS A DOUBLE WALL DESIGN. THE SHAKER ALSO FEATURE A COOL, RIBBED DESIGN AROUND THE BODY.  
WC-72704 3 PCS.  
22 OZ.  
**DOUBLE WALL**



**COCKTAIL SHAKER (STAINLESS)**  
MIRROR FINISH.  
WC-7500 3 PCS.  
24 OZ.



**ANTIQUE COPPER COCKTAIL SHAKER**  
THESE ANTIQUE COPPER MOSCOW COCKTAIL SHAKERS ARE A GREAT ADDITION TO THE EVENT. THEY CAN BE PURCHASED IN HAMMERED OR SATIN FINISH.  
24 OZ., 4" DIA X 9 1/4" H.

ACC-540 SATIN  
ACC-541 HAMMERED



**DRINK CAN (STAINLESS STEEL)**  
BRSS-1150 15 OZ. 3" DIA. X 5" H.



**JEFFERSON STYLE CUP (PEWTER)**  
COMES COMPLETE WITH A GIFT BOX.  
BRPB-300  
8 OZ., 3.5" DIA., 2.5" H.



**BAR SHAKERS, 3 PIECES SET (STAINLESS STEEL)**  
SHAKE UP SOME FUN AT YOUR RESTAURANT OR BAR WITH BAR SHAKER.  
AC-1287 10 OZ.  
AC-1291 28 OZ.  
AC-1292 16 OZ.



**COCKTAIL SHAKER (STAINLESS)**  
THIS COCKTAIL SHAKER IS MADE OF STAINLESS STEEL AND FEATURES A UNIQUE HAMMERED DESIGN.  
AC-72644 3 PCS.  
24 OZ.



**COCKTAIL SHAKERS, 3 PC SET (STAINLESS STEEL)**  
AC-1330 8 OZ.  
AC-1331 16 OZ.  
AC-1332 28 OZ.

**NEW!**



**BAR SHAKERS (STAINLESS)**  
MUST BUY IN CASE PACKS OF 12 EACH.  
AC-1288  
30 OZ., 11" x 5" x 5"  
AC-1289  
15 OZ., 10" x 5" x 5"



**SIMON SQUARE CRYSTAL DECANTER**  
THIS SIMON OPTIC CRYSTAL DECANTER IS LEAD FREE. IT HOLD UP TO 32 OUNCES AND STANDS 10.25" TALL. IT ALSO COMES GIFT BOXED.  
DCT-4120  
32 OZ., 10.25" TALL

# MINT JULEP CUPS & TANKARDS



**MINT JULEP CUPS (STAINLESS)**  
SPUN BASE BOTTOM, BEADED EDGE AROUND TOP AND BOTTOM.

BRS-2341	4.5" H.	14 OZ.
BRS-2342	3.5" H.	6 OZ.
BRS-2343	2.75" H.	4 OZ.



**MINT JULEP CUPS (SILVERPLATE)**  
BEADED EDGE DESIGN. ENGRAVABLE!

BRS-6940	2.75" HT.	3.5 OZ.
BRS-6941	3.25" HT.	6 OZ.
BRS-6942	4.5" HT.	12 OZ.



**MINT JULEP (NICKELPLATED)**  
BEADED BORDER ON THE TOP AND BOTTOM OF THE CUP WITH A SPUN BASE BOTTOM.

BRS-2344  
20 OZ., 6" H.



**MINT JULEP CUPS (SILVERPLATE)**  
BEADED EDGE AROUND THE TOP AND BOTTOM OF THE CUP.  
SOLD IN CASE PACKS ONLY!

BRS-54600	4 OZ.	3.25" H.	<b>CASE PACK</b> 48 EACH
BRS-54601	9 OZ.	4.25" H.	48 EACH
BRS-54602	26 OZ.	6.25" H.	24 EACH



**MINT JULEP CUP (COPPERPLATED)**  
SPUN BASE BOTTOM WITH BEADED EDGE AROUND THE TOP AND BOTTOM. HAND WASH ONLY.

BRC-500	2.75" H., 3.75 OZ.
BRC-502	4.5" H., 12 OZ.



**MINT JULEP CUP (SILVERPLATE)**  
BRS-1960 7 OZ., 3.5" H. x 3.125" DIA.



**MINT JULEP CUPS (SILVERPLATE)**  
BEADED EDGE DESIGN.

BRS-1062 16 OZ., 5.5" H.



**MINT JULEP CUP (PEWTER)**  
ENGRAVABLE!

BRPB-1032 9 OZ. 4" H.



**MINT JULEP CUP (STAINLESS)**  
A BEADED DESIGN ALONG THE TOP AND BASE.

BRSS-8200 8 OZ., 4.5" H.



**MINT JULEP CUP (GOLDPLATED)**  
A BEADED DESIGN ALONG THE TOP AND BASE.

BRSG-900 12 OZ., 4.375" H.



**MINT JULEP CUP (BRUSHED STAINLESS STEEL)**  
THEY ARE MADE FROM BRUSHED STAINLESS STEEL. THREE SIZES ARE GREAT FOR ANY DRINK EVENT, OR EVEN FOR ENGRAVING. SOLD IN CASE PACKS OF ONE DOZEN ONLY!

BRSS-1100	11 OZ.	3" DIA., 4 1/4" H.
BRSS-1101	8 OZ.	2 7/8" DIA., 3 7/8" H.
BRSS-1102	14 OZ.	3 1/4" DIA., 4 5/8" H.



**HAMMERED MINT JULEP CUPS (STAINLESS)**  
THESE ELEGANT HAMMERED MINT JULEP CUP WILL ADD FLAIR TO YOUR DRINK. THE BEADED TOP AND BOTTOM ADD A TOUCH OF CLASS AS WELL. THE STAINLESS STEEL CONSTRUCTION MAKE FOR EASY MAINTENANCE

BRSS-7240	4 OZ.	3" H.
BRSS-7241	10 OZ.	4" H.
BRSS-7242	12 OZ.,	4.75" H.



**MINT JULEP CUP (PEWTER)**  
BRIGHT FINISH MINT JULEP CUP.

BRPB-2395 10 OZ., 3" x 3.75" H.



**MINT JULEP CUP (SILVERPLATE)**  
THIS MINT JULEP CUP HAS SPUN BASE BOTTOM. ENGRAVABLE!

BRS-1962 11 OZ., 4" H. x 3.125" DIA.



**MINT JULEP CUPS (STAINLESS STEEL)**  
THIS CLASSIC MINT JULEP CUP FEATURES A PLAIN BORDER ON THE TOP AND BOTTOM OF THE CUP.

**NEW!**

BRSS-1500	11 OZ., 3" DIA. X 4 3/8" H.
BRSS-1501	41 OZ., 3 3/8" DIA. X 4 3/4" H.



BRSS-6000 12 OZ. 3 1/2" TOP DIA. X 4 1/2" H.

BRC-6000 12 OZ. 3 1/2" TOP DIA. X 4 1/2" H.



**MINT JULEP CUP WITH BEADED EDGES**  
THESE JULEP CUPS ARE DESIGNED FOR THE PERFECT SIZED MINT JULEP. THE BEADED EDGES ADD BEAUTY AND CLASS TO THE CUP. SOLD IN THE CASE PACKS ONLY.

STAINLESS STEEL	14 EACH
COPPERPLATED	12 EACH



**MINT JULEP CUPS WITH BEADED EDGE (MIRROR FINISH STAINLESS STEEL)**  
THIS CLASSIC MINT JULEP CUP HAS A BEADED EDGE AT THE TOP. SOLD IN THE CASE PACKS OF 6.

BRSS-1200	12 OZ, 3 3/8" DIA. X 4 1/2" H.
BRSS-1201	16 OZ, 3 5/8" DIA. X 5 3/4" H.
BRSS-1202	48 OZ, 5 1/4" DIA. X 7 5/8" H.



**TANKARDS WITH GLASS BOTTOM (PEWTER)**  
COME WITH A GIFT BOX.

BRPB-5520 BRUSHED SATIN FINISH, 16 OZ., 4.5" TALL  
BRPB-5521 BRIGHT POLISH FINISH, 16 OZ., 4.5" TALL



**TANKARDS (STAINLESS)**  
COME WITH A GIFT BOX.

BRSS-5510 SATIN FINISH, 20 OZ., 4.5" TALL  
BRSS-5511 POLISH FINISH, 20 OZ., 4.5" TALL



**TANKARDS (PEWTER)**  
THIS TANKARD IS MADE OF GENUINE PEWTER WITH A GLASS BOTTOM. MIRROR FINISH

BRPB-2344 18 OZ.



**TANKARD (SATIN FINISH STAINLESS)**  
FEATURES AS SOLID BOTTOM.

BRPB-7300 16 OZ., 4.5" TALL

# MULE MUGS & DRINKWARE



MG-600	20 OZ.	4" H. x 3.25" DIA. (5" DIA. W/HANDLE)
MG-601	20 OZ.	4" H. x 3.25" DIA. (5" DIA. W/HANDLE)
MG-602	20 OZ.	4" H. x 3.25" DIA. (5" DIA. W/HANDLE)
MG-603	20 OZ.	4" H. x 3.25" DIA. (5" DIA. W/HANDLE)
MG-604	20 OZ.	4" H. x 3.25" DIA. (5" DIA. W/HANDLE)
MG-605	20 OZ.	4" H. x 3.25" DIA. (5" DIA. W/HANDLE)
MG-606	20 OZ.	4" H. x 3.25" DIA. (5" DIA. W/HANDLE)
MG-607	20 OZ.	4" H. x 3.25" DIA. (5" DIA. W/HANDLE)
MG-608	20 OZ.	4" H. x 3.25" DIA. (5" DIA. W/HANDLE)
MG-609	20 OZ.	4" H. x 3.25" DIA. (5" DIA. W/HANDLE)

**MULE MUGS**  
 THESE PURE COPPER AND COLORED FINISHED STAINLESS MOSCOW MULE MUGS HAVE A DECORATIVE ANGULAR BRASS HANDLE AND OFFER A UNIQUE BEVERAGE SERVICE EXPERIENCE. GREAT FOR WEDDINGS AND EVENTS! FOOD SAFE. HAND WASHING RECOMMENDED. SOLD CASE PACKS OF 24 ONLY!

PURE COPPER, NICKEL LINED	24 EACH
COPPER FINISH OVER STAINLESS	24 EACH
HAMMERED COPPER FINISH OVER STAINLESS	24 EACH
AQUA FINISH STAINLESS	24 EACH
AMBER FINISH STAINLESS	24 EACH
BLACK NICKEL FINISH STAINLESS	24 EACH
GOLD FINISH STAINLESS	24 EACH
RED FINISH STAINLESS	24 EACH
FINISH STAINLESS	24 EACH
BLUE FINISH STAINLESS	24 EACH
LIGHT BLUE FINISH STAINLESS	24 EACH



**BLACK MOSCOW MULE MUGS**  
 THE MUG IS FOOD SAFE BUT MUST BE HAND WASHED. SOLD CASE PACKS OF 24 ONLY! 16 OZ., 4.75" TALL

MG-100 HAMMERED  
 MG-101 PLAIN



**MULE MUGS (STAINLESS STEEL)**  
 IT HAS A DECORATIVE CRIMPED HANDLE AND A SLEEK, BARREL-SHAPED CUP. THE MUG IS FOOD SAFE. SOLD CASE PACKS OF 24 ONLY! 16 OZ., 4" TALL

MG-613 PLAIN  
 MG-614 HAMMERED

**MOSCOW MULE MUGS**  
 THIS COPPER-PLATED OVER STAINLESS STEEL MOSCOW MULE MUG HAS AN ANGULAR BRASS HANDLE. 20 OZ., 4.5" H. x 5" T. x 3.25" DIA.

MG-200 PLAIN  
 MG-201 HAMMERED

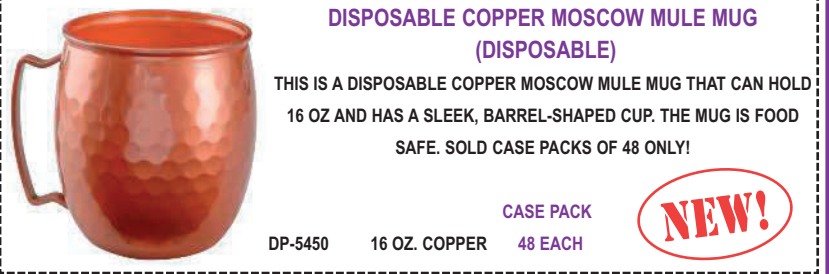

**DISPOSABLE COPPER MOSCOW MULE MUG (DISPOSABLE)**  
 THIS IS A DISPOSABLE COPPER MOSCOW MULE MUG THAT CAN HOLD 16 OZ AND HAS A SLEEK, BARREL-SHAPED CUP. THE MUG IS FOOD SAFE. SOLD CASE PACKS OF 48 ONLY!

DP-5450 16 OZ. COPPER



**DOUBLE WALL STEMLESS WINE GLASS (STAINLESS STEEL WITH GOLD FINISH)**  
 THIS IS A GOLD WINE GLASS THAT IS STAINLESS STEEL, DOUBLE WALLED, AND CAN HOLD 16 OZ. IT HAS A SHINY AND SLEEK BARREL-SHAPED CUP. THE MUG IS FOOD SAFE. SOLD CASE PACKS OF 24 ONLY!

MG-2800 16 OZ., GOLD FINISH  
 MG-2800 16 OZ., HAMMERED BLACK FINISH



**ANTIQUE COPPER MOSCOW MULE TUMBLERS**  
 THESE ANTIQUE COPPER MINI TUMBLERS ARE A GREAT ADDITION TO THE EVENT. SOLD IN THE CASE PACKS LISTED.

MG-150	3 OZ.	1 1/2" DIA. x 2" H.	SATIN	12 EA.
MG-151	3 OZ.	1 1/2" DIA. x 2"	HAMMERED	12 EA.
MG-155	14 OZ.	2 3/4" DIA. x 3 1/2" H.	SATIN	6 EA.
MG-156	14 OZ.	2 3/4" DIA. x 3 1/2" H.	HAMMERED	6 EA.



**RIBBED BARREL MUGS**  
 THESE DOUBLE WALLED STAINLESS STEEL RIBBED BARREL MUGS WILL HOLD 16 OZ. OF THE RECIPIENTS FAVORITE BEVERAGE. THE MANY COLOR OPTIONS MAKING IT PERFECT FOR A VARIETY OF OCCASIONS. SOLD CASE PACKS OF 16 ONLY!

MG-7003 16 OZ., 3" DIA., 5" TALL BRUSHED MATTE FINISH  
 MG-7004 16 OZ., 3" DIA., 5" TALL GOLD FINISH



**DRINKWARE (STAINLESS STEEL)**  
 THIS COLLECTION OF STAINLESS STEEL DRINKWARE IS AVAILABLE IN MIRROR FINISH OR HAMMERED STAINLESS STEEL. THE WINE GLASS AND CHAMPAGNE FLUTE OFFER A GENEROUS CAPACITY. THE MARTINI GLASS AND PILSNER FEATURE DOUBLE WALL STAINLESS STEEL TO KEEP BEVERAGES COOLER LONGER. SOLD IN THE CASE PACKS ONLY.



DRSS-5400	WINE GLASS, MIRROR FINISH	16 OZ.	2 3/4" DIA. X 9" H.	8 EACH
DRSS-5401	WINE GLASS, HAMMERED FINISH	16 OZ.	2 3/4" DIA. X 9" H.	8 EACH
DRSS-5402	CHAMPAGNE FLUTE, MIRROR FINISH	10 OZ.	2" DIA. X 9" H.	8 EACH
DRSS-5403	CHAMPAGNE FLUTE, HAMMERED FINISH	10 OZ.	2" DIA. X 9" H.	8 EACH
DRSS-5404	MARTINI GLASS, DOUBLE WALL, MIRROR FINISH	7 OZ.	4 1/2" DIA. X 3 3/4" H.	6 EACH
DRSS-5405	MARTINI GLASS, DOUBLE WALL, HAMMERED FINISH	7 OZ.	4 1/2" DIA. X 3 3/4" H.	6 EACH
DRSS-5406	PILSNER, DOUBLE WALL, MIRROR FINISH	16 OZ.	3" DIA. X 8 1/4" H.	6 EACH
DRSS-5407	PILSNER, DOUBLE WALL, HAMMERED FINISH	16 OZ.	3" DIA. X 8 1/4" H.	6 EACH



**NON BREAKABLE DRINKWARE**

<p><b>SPECIALTY DRINKWARE COLLECTION (SAN PLASTIC)</b></p>	 <p><b>GL-1250</b> 16.5 OZ., 3" x 6" H. TEXTURED BELL SODA TUMBLER CASE PACK: 6 DOZ.</p>	 <p><b>GL-1251</b> 20 OZ., 3.5" x 6.5" H. TEXTURED BELL SODA TUMBLER CASE PACK: 6 DOZ.</p>	 <p><b>GL-1252</b> 24 OZ., 3.5" x 7" H. TEXTURED BELL SODA TUMBLER CASE PACK: 6 DOZ.</p>	 <p><b>GL-1300</b> 8 OZ., 5.5" H. 2 1/8" T., 2 3/4" B., 3" D. FLUTED WINE CASE PACK: 2 DOZ.</p>	 <p><b>GL-1301</b> 8 OZ., 7 1/8" H. 2 1/2" T., 2 3/4" B., 4 3/4" D. FLUTED WINE CASE PACK: 2 DOZ.</p>	 <p><b>GL-1302</b> 6 OZ., 8 1/4" H. 2 1/8" T., 2 3/4" B. FLUTED CHAMPAGNE CASE PACK: 2 DOZ.</p>	 <p><b>GL-1316</b> 36 OZ. 5.25" x 8" H. SCHOONER CASE PACK: 1 DOZ.</p>	 <p><b>GL-1500</b> 10 OZ., 5.75" H. 4" DIA. (INCL. HANDLE) IRISH MUG CASE PACK: 2 DOZ.</p>
 <p><b>GL-1502</b> 12 OZ. 3.4" DIA., 4.45" H. STEMLESS CASE PACK: 2 DOZ.</p>	 <p><b>GL-2249</b> 3 OZ. 3.13" x 3" H. MARTINI CASE PACK: 2 DOZ.</p>	 <p><b>GL-2250</b> 1 OZ. 1.7" x 2.75" H. SHOOTER CASE PACK: 4 DOZ.</p>	 <p><b>GL-2251</b> 1 OZ. 2" x 2.75" H. SHOT GLASS CASE PACK: 1 DOZ.</p>	 <p><b>GL-2252</b> 20 OZ., 5 1/2" H. 3 1/4" T., 3" B., 5 1/2" D. BEER MUG CASE PACK: 2 DOZ.</p>	 <p><b>GL-2253</b> 16 OZ., 6.25" H. 3.25" (5" WITH HANDLE) BEER MUG CASE PACK: 2 DOZ.</p>	 <p><b>GL-2254</b> 12 OZ., 5.5" H. 3" (4.5" WITH HANDLE) BEER MUG CASE PACK: 2 DOZ.</p>	 <p><b>GL-2255</b> 10 OZ., 5" H. 2.75" (4" WITH HANDLE) BEER MUG CASE PACK: 2 DOZ.</p>	 <p><b>GL-2256</b> 20 OZ., 6.25" H. 3.5" (5" WITH HANDLE) BEER MUG CASE PACK: 1 DOZ.</p>
 <p><b>GL-2257</b> 10 OZ. 4.63" x 7.5" H. MARTINI CASE PACK: 2 DOZ.</p>	 <p><b>GL-2258</b> 16 OZ. 4" x 5.5" H. BRANDY CASE PACK: 2 DOZ.</p>	 <p>AVAILABLE IN CLEAR(CL), BLUE(BL), GREEN(G), ORANGE(O), PINK(PI), YELLOW(Y). <b>GL-2259</b> 15 OZ. 3.13" x 8" H. HURRICANE CASE PACK: 2 DOZ.</p>	 <p>ONLY IN CLEAR(CL). <b>GL-2260</b> 22 OZ. 3.13" x 9.13" H. HURRICANE CASE PACK: 2 DOZ.</p>	 <p><b>GL-2261</b> 22 OZ. 3 1/4" x 9" H. PILSNER CASE PACK: 2 DOZ.</p>	 <p><b>GL-2262</b> 12 OZ. 3 1/4" x 7.25" H. PILSNER CASE PACK: 2 DOZ.</p>	 <p><b>GL-2263</b> 16 OZ. 3 1/2" x 6" H. SHAKER CASE PACK: 2 DOZ.</p>	 <p><b>GL-2264</b> 2 OZ. 1 1/2" x 4.5" H. PILSNER SHOT CASE PACK: 2 DOZ.</p>	 <p><b>GL-2265</b> 3 OZ. 1.75" x 3.75" H. SHOOTER CASE PACK: 2 DOZ.</p>
 <p><b>GL-2266</b> 1.5 OZ. 2" x 2.25" H. SHOT GLASS CASE PACK: 2 DOZ.</p>	 <p><b>GL-2267</b> 12 OZ. 4.25" x 6" H. MARGARITA CASE PACK: 2 DOZ.</p>	 <p><b>GL-2268</b> 16 OZ. 5" x 6.25" H. MARGARITA CASE PACK: 2 DOZ.</p>	 <p><b>GL-2269</b> 16 OZ., 5" H. 3.25" (3.5" WITH HANDLE) MASON JAR CASE PACK: 2 DOZ.</p>	 <p><b>GL-2271</b> 12 OZ. 3.75" x 6" H. GOBLET CASE PACK: 2 DOZ.</p>	 <p><b>GL-2272</b> 8 OZ. 2.75" x 7" H. WINE CASE PACK: 2 DOZ.</p>	 <p><b>GL-2273</b> 6 OZ. 3" x 5 1/2" H. WINE CASE PACK: 2 DOZ.</p>	 <p><b>GL-2274</b> 6 OZ., 2.75" x 8.25" H. CHAMPAGNE CASE PACK: 2 DOZ.</p>	 <p><b>GL-2275</b> 12 OZ. 3" x 7" H. GOBLET CASE PACK: 2 DOZ.</p>
 <p><b>GL-2276</b> 8 OZ. 3" x 5.5" H. GOBLET CASE PACK: 2 DOZ.</p>	 <p><b>GL-2277</b> 9 OZ. 2.5" x 5.25" H. HIGH BALL CASE PACK: 2 DOZ.</p>	 <p><b>GL-2278</b> 14 OZ. 2.5" x 7" H. TOM COLLINS CASE PACK: 2 DOZ.</p>	 <p><b>GL-2279</b> 17.5 OZ. 3.75" x 8" H. 3 PC. SHAKER SET CASE PACK: 2 DOZ.</p>	 <p><b>GL-2280</b> 6 OZ. 4 1/4" x 5 3/4" H. MARTINI CASE PACK: 2 DOZ.</p>	 <p>AVAILABLE IN CLEAR(CL), BLUE(BL), JADE(JA), RED(R). <b>GL-2281</b> 22 OZ. 3.69" x 6.63" H. BAHAMA COOLER CASE PACK: 6 DOZ.</p>	 <p>AVAILABLE IN CLEAR(CL), BLUE(BL), JADE(JA), RED(R). <b>GL-2282</b> 16 OZ. 3.38" x 6" H. BAHAMA BEVERAGE CASE PACK: 6 DOZ.</p>	 <p>AVAILABLE IN CLEAR(CL), BLUE(BL), JADE(JA), RED(R). <b>GL-2283</b> 14 OZ. 3.44" x 5" H. BAHAMA BEVERAGE CASE PACK: 6 DOZ.</p>	<p>AVAILABLE IN CLEAR(CL), BLUE(BL), JADE(JA), RED(R). <b>GL-2284</b> 12 OZ. 3.5" x 4" H. BAHAMA DOUBLE ROCKS CASE PACK: 6 DOZ.</p>

# NON BREAKABLE DRINKWARE

<p><b>SPECIALTY DRINKWARE COLLECTION (SAN PLASTIC)</b></p>	<p>AVAILABLE IN CLEAR(CL), BLUE(BL), JADE(JA), RED(R).</p>  <p><b>GL-2285</b> 10 OZ. 3.13" x 4.75" H. BAHAMA DOUBLE ROCKS CASE PACK: 6 DOZ.</p>	<p>AVAILABLE IN CLEAR(CL), BLUE(BL), RED(R).</p>  <p><b>GL-2286</b> 10 OZ. 3.13" x 4.75" H. BAHAMA DOUBLE ROCKS CASE PACK: 6 DOZ.</p>	<p>AVAILABLE IN CLEAR(CL), BLUE(BL), RED(R).</p>  <p><b>GL-2287</b> 7 OZ. 3" x 3.25" H. BAHAMA ROCKS CASE PACK: 6 DOZ.</p>	<p>AVAILABLE IN CLEAR(CL), BLUE(BL), JADE(JA), RED(R).</p>  <p><b>GL-2288</b> 5.5 OZ. 2.88" x 3" H. BAHAMA ROCKS CASE PACK: 6 DOZ.</p>	<p>AVAILABLE IN CLEAR(CL), JADE(JA).</p>  <p><b>GL-2289</b> 32 OZ. 4.13" x 7.25" H. BAHAMA COOLER CASE PACK: 6 DOZ.</p>	 <p><b>GL-2290</b> 9 OZ. 3.31" x 3.38" H. ROCKS CASE PACK: 2 DOZ.</p>	 <p><b>GL-2291</b> 12.5 OZ. 3.75" x 4.75" H. BEVERAGE CASE PACK: 2 DOZ.</p>	 <p><b>GL-2292</b> 14 OZ. 3" x 5 1/2" H. BEVERAGE CASE PACK: 2 DOZ.</p>				
	 <p><b>GL-2293</b> 10 OZ. 3.5" x 3.5" H. ROCKS CASE PACK: 2 DOZ.</p>	 <p><b>GL-2294</b> 15 OZ. 3.75" DIA., 8.5" H. TALL WINE CASE PACK: 2 DOZ.</p>	 <p><b>GL-2295</b> 20 OZ. 4.5" DIA., 8.25" H. BALLOON WINE CASE PACK: 2 DOZ.</p>	 <p><b>GL-2296</b> 5 OZ. 2.25" DIA., 4" H. JUICE GLASS CASE PACK: 2 DOZ.</p>	 <p><b>GL-22705</b> 32 OZ. 6.25" x 6.75" H. SUPER MARGARITA CASE PACK: 1 DOZ.</p>	 <p><b>GL-22745</b> 7/8 OZ. 1.88" x 2.25" H. SHOT GLASS CASE PACK: 2 DOZ.</p>	 <p><b>GL-22795</b> 20 OZ. 7.5" H. 3 PC SHAKER SET CASE PACK: 2 DOZ.</p>	 <p><b>GL-0300</b> 8 OZ. 5.75" T: 4.125" H. MYSTIC COUPE CASE PACK: 1 DOZ.</p>				
	<p><b>GATSBY DRINKWARE COLLECTION (POLYCARBONATE)</b></p>	 <p><b>GL-02010</b> 10 1/4 OZ. WINE GLASS CASE PACK: 1 DOZ.</p>	 <p><b>GL-02011</b> 7 OZ. CHAMPAGNE FLUTE CASE PACK: 1 DOZ.</p>	 <p><b>GL-02012</b> 16 OZ. HI-BAL CASE PACK: 1 DOZ.</p>	 <p><b>GL-02013</b> 16 OZ. OLD FASHIONED CASE PACK: 1 DOZ.</p>	 <p><b>GL-02014</b> 1 LITER CARAFE CASE PACK: 1 DOZ.</p>						
		<p><b>LIBERTY DRINKWARE COLLECTION (POLYCARBONATE)</b></p>	 <p><b>GL-1650</b> 5 OZ., 8.66 H. 3.26" DIA. B. x 2.74" DIA. T. CHAMPAGNE FLUTE CASE PACK: 2 DOZ.</p>	 <p><b>GL-1651</b> 10.5 OZ., 6.48" H. 3.26" DIA. B. x 3.40" DIA. T. WHITE WINE CASE PACK: 2 DOZ.</p>	 <p><b>GL-1652</b> 13.5 OZ., 7.09" H. 3.27" DIA. B. x 3.69" DIA. T. GOBLET CASE PACK: 2 DOZ.</p>	 <p><b>GL-1653</b> 15 OZ., 8.67" H. 3.13" DIA. B. x 3.32" DIA. T. PILSNER CASE PACK: 2 DOZ.</p>	<p><b>TUMBLERS COLLECTION (BREAK RESISTANT)</b></p>	 <p><b>GLP-450</b> 9 OZ. BLUE PLASTIC HAVANA TUMBLER CASE PACK: 1 DOZ.</p>	 <p><b>GLP-451</b> 12 OZ. BLUE PLASTIC HAVANA TUMBLER CASE PACK: 1 DOZ.</p>	 <p><b>GLP-452</b> 16 OZ. BLUE PLASTIC HAVANA TUMBLER CASE PACK: 1 DOZ.</p>		
			 <p><b>GL-1654</b> 9.5 OZ., 6.14" H. 3.26" DIA. B. x 4.7" DIA. T. MARGARITA CASE PACK: 2 DOZ.</p>	 <p><b>GL-1655</b> 18 OZ. 5.13" H. 2.93" DIA. B. x 3.53" DIA. T. DOUBLE OLD FASHIONED CASE PACK: 2 DOZ.</p>	 <p><b>GL-1656</b> 22OZ., 6.66" H. 2.74" DIA. B. x 3.53" DIA. T. HI-BALL CASE PACK: 2 DOZ.</p>	 <p><b>GL-1657</b> 8 OZ., 6.25" H. 3" DIA. B. x 4.38" DIA. T. MARTINI CASE PACK: 2 DOZ.</p>		 <p><b>GL-1658</b> 8 OZ., 3.25" H. 2.25" DIA. B. x 2.81" DIA. T. OLD FASHIONED CASE PACK: 4 DOZ.</p>	<p><b>DRINKWARE COLLECTION (POLYCARBONATE)</b></p>	 <p><b>GL-95443</b> 4 QT. 8" DIA., 8.5" H. ICE BUCKET CASE PACK: 1 EACH</p>	 <p><b>GL-95444</b> 4 QT., 8" DIA., 8.5" H. ICE BUCKET WITH 6" PC TONG CASE PACK: 1 EACH</p>	 <p><b>GL-95476</b> 16 OZ. 8.75" H. SHOT SHAKER CASE PACK: 1 DOZ.</p>

**NON BREAKABLE DRINKWARE**





<p><b>DRINKWARE COLLECTION</b> (POLYCARBONATE)</p>	 <p><b>GL-95442</b> 16 OZ., 6 1/4" H. BEER MUG 2 DOZ.</p>	 <p><b>GL-95445</b> 17 OZ., 0.5 L., 6" H. CARAFE 1 DOZ.</p>	 <p><b>GL-95446</b> 750 ML., 9 7/8" H. DECANTER NAPA 1 DOZ.</p>	 <p><b>GL-95447</b> 34 OZ., 1.0 L., 9.75" H. CARAFE 1 DOZ.</p>	 <p><b>GL-95448</b> 8 OZ., 3 7/8" H. COCKTAIL, HEAVY BASE 1 DOZ.</p>	 <p><b>GL-95449</b> 7 OZ., 9" H. CHAMPAGNE 1 DOZ.</p>	 <p><b>GL-95450</b> 16 OZ., 6 1/4" H. ENGLISH PUB GLASS 1 DOZ.</p>	 <p><b>GL-95451</b> 20 OZ., 6 1/8" H. ENGLISH PUB GLASS 1 DOZ.</p>
 <p><b>GL-95452</b> 5 OZ., 2" H. FRUIT TRAY 1 DOZ.</p>	 <p><b>GL-95453</b> 20 OZ., 7 3/4" H. GOBLET 1 DOZ.</p>	 <p><b>GL-95454</b> 16 OZ., 8" H. HURRICANE 1 DOZ.</p>	 <p><b>GL-95455</b> 24 OZ., 9 1/4" H. HURRICANE 1 DOZ.</p>	 <p><b>GL-95456</b> 16 OZ., 6" H. MIXING GLASS 1 DOZ.</p>	 <p><b>GL-95457</b> 20 OZ., 6 3/4" H. MIXING GLASS 1 DOZ.</p>	 <p><b>GL-95458</b> 9 OZ., 6" H. MARGARITA 1 DOZ.</p>	 <p><b>GL-95459</b> 11 OZ., 6" H. MARGARITA 1 DOZ.</p>	 <p><b>GL-95460</b> 13 OZ., 8 1/4" H. PILSNER STARBURST BASE 1 DOZ.</p>
 <p><b>GL-95461</b> 23 OZ., 10" H. PILSNER STARBURST BASE 1 DOZ.</p>	 <p><b>GL-95462</b> 8.5 OZ., 3 1/8" H. HEAVY BASE ROCKS GLASS 1 DOZ.</p>	 <p><b>GL-95463</b> 10 OZ., 3 1/2" H. HEAVY BASE ROCKS GLASS 1 DOZ.</p>	 <p><b>GL-95464</b> 12 OZ., 3 7/8" H. HEAVY BASE ROCKS GLASS 1 DOZ.</p>	 <p><b>GL-95465</b> 8 OZ., 3 1/4" H. ROCKS GLASS STARBURST BASE 1 DOZ.</p>	 <p><b>GL-95466</b> 10 OZ., 3 5/8" H. ROCKS GLASS STARBURST BASE 1 DOZ.</p>	 <p><b>GL-95467</b> 12 OZ., 3 7/8" H. ROCKS GLASS STARBURST BASE 1 DOZ.</p>	 <p><b>GL-95468</b> 1 OZ., 1 1/2" H. HEAVY BASE SHOT GLASS 2 DOZ.</p>	 <p><b>GL-95469</b> 2 OZ., 3 7/8" H. FLAIR DESIGN HEAVY BASE SHOT GLASS, 2 DOZ.</p>
 <p><b>GL-95470</b> 2 OZ., 4 1/2" H. HEAVY BASE SHOT GLASS 2 DOZ.</p>	 <p><b>GL-95471</b> 1.5 OZ., 3 1/4" H. HEAVY BASE SHOT GLASS 2 DOZ.</p>	 <p><b>GL-95472</b> 2.5 OZ., 2 1/2" H. HEAVY BASE SHOT GLASS, SQUARE 2 DOZ.</p>	 <p><b>GL-95473</b> 3 OZ., 2 1/2" H. HEAVY BASE SHOT GLASS, SQUARE 2 DOZ.</p>	 <p><b>GL-95474</b> CARAFE SNAP LID FOR 17 OZ. &amp; 34 OZ. POLYCARBONATE 1 DOZ.</p>	 <p><b>GL-95475</b> 24 OZ. 7 1/4" H. SCHOONER 1 DOZ.</p>	 <p><b>GL-95477 STACKABLE</b> 12 OZ., 5 1/2" H. HEAVY BASE CLASSIC TUMBLER 1 DOZ.</p>	 <p><b>GL-95478 STACKABLE</b> 14 OZ., 6 1/2" H. HEAVY BASE CLASSIC TUMBLER 1 DOZ.</p>	 <p><b>GL-95479</b> 12 OZ., 5 7/8" H. STACKABLE STARBURST TUMBLER 1 DOZ.</p>
 <p><b>GL-95480</b> 14 OZ., 6 1/8" H. STARBURST TUMBLER 1 DOZ.</p>	 <p><b>GL-95481</b> 9 OZ., 5 1/4" H. WINE DECANTER 1 DOZ.</p>	 <p><b>GL-95482</b> 14 OZ., 9 3/4" H. RED WINE GLASS 1 DOZ.</p>	 <p><b>GL-95483</b> 23 OZ., 9" H. RED WINE GLASS 1 DOZ.</p>	 <p><b>GL-95484</b> 25 OZ., 8 5/8" H. RED WINE GLASS 1 DOZ.</p>	 <p><b>GL-95485</b> 1.5 L., 51 OZ., 9 1/2" H. STARBURST BASE WATER PITCHER</p>	 <p><b>GL-95486</b> 2 L., 68 OZ., 10 1/2" H. STARBURST BASE WATER PITCHER</p>	 <p><b>GL-95487</b> 32 OZ THREE SPOUT WATER PITCHER 1 DOZ.</p>	 <p><b>GL-95488</b> 64 OZ THREE SPOUT WATER PITCHER 1 DOZ.</p>

# GLASSWARE









































 <p><b>GL-22</b> 12 OZ., 6" H. 2 1/2" T., 2 1/4" B. LIVINGSTON ZOMBIE CASE PACK: 2 DOZ. TRAEX RACK: TR-7CCC</p>	 <p><b>GL-9921</b> 6.5 OZ., 8 1/8" H. 2" D. CHAMPAGNE FLUTE CASE PACK: 2 DOZ. TRAEX RACK: TR-7CCCC</p>	 <p><b>GL-9922</b> 12 OZ., 4 3/8" H. 3 1/2" D. X 2 1/2" B. ROCKS CASE PACK: : 1 DOZ. TRAEX RACK: TR-6B</p>	 <p><b>GL-9923</b> 14 OZ., 5 5/8" H. 3 5/16" D. HI BALL -RIM TEMPERED CASE PACK: 2 DOZ. TRAEX RACK: TR-6BB</p>	 <p><b>GL-9924</b> 16 OZ., 6 5/16" H. 3 5/16" D. BEER - RIM TEMPERED CASE PACK: 2 DOZ. TRAEX RACK: TR-6BB</p>	 <p><b>GL-9925</b> 12 OZ. 5 1/4" H., 3 3/4" D. BANQUET WATER GOBLET CASE PACK: 4 DOZ. TRAEX RACK: TR-6BB</p>	 <p><b>GL-9926</b> 8.25 OZ. 6 1/2" H., 3 1/4" W. LONDON RED WINE CASE PACK: 2 DOZ. TRAEX RACK: TR-6BBB</p>	 <p><b>GL-9927</b> 20 OZ., 8 1/8" H. 3 3/8" D. BALLOON RED WINE CASE PACK: 2 DOZ. TRAEX RACK: TR-8DDDD</p>	 <p><b>GL-9928</b> 8 OZ., 7 1/2" H. 2 1/8" D. WHITE WINE CASE PACK: 2 DOZ. TRAEX RACK: TR-7CCC</p>
 <p><b>GL-9929</b> 21 OZ., 8 5/8" H. 2 7/8" D. BALLOON WHITE WINE CASE PACK: 2 DOZ. TRAEX RACK: TR-8DDDD</p>	 <p><b>GL-9930</b> 14 OZ. 6.25" H., 3.25" W. PILSNER CASE PACK: DOZ. TRAEX RACK: TR-6BB</p>	 <p><b>GL-9931</b> 8 OZ., 5 5/8" H. 2 7/8" D. IRISH COFFEE MUG CASE PACK: 4 DOZ. TRAEX RACK: TR-7CC</p>	 <p><b>GL-9932</b> 13 OZ. 5 1/2" H., 3" W. DAKOTA SPORTS MUG CASE PACK: 3 DOZ. TRAEX RACK: TR-10FF</p>	 <p><b>GL-9934</b> 9.75 OZ., 6 3/8" H. 2 5/8" D. PILSNER CASE PACK: 4 DOZ. TRAEX RACK: TR-7CC</p>	 <p><b>GL-9935</b> 20 OZ., 8 7/8" H. 3" D. PILSNER CASE PACK: 2 DOZ. TRAEX RACK: TR-6BBB</p>	 <p><b>GL-9937</b> 10 OZ. 6 1/2" H., 2 7/8" W. LEXINGTON PILSNER CASE PACK: 4 DOZ. TRAEX RACK: TR-7CC</p>	 <p><b>GL-9943</b> 3 OZ., 2 7/8" H., 2 1/8" D. HEAVY BASE FLARED SHOT CASE PACK: 6 DOZ. TRAEX RACK: TR-7</p>	 <p><b>GL-9944</b> 1.5 OZ. 2 1/8" H., 1 7/8" D. SHOT, HEAVY BASE CASE PACK: 6 DOZ. TRAEX RACK: TR-9</p>
 <p><b>GL-9946</b> 13 OZ. 6 3/8" H., 3" W. DECANTER CASE PACK: 2 DOZ. TRAEX RACK: TR-6BB</p>	 <p><b>GL-9947</b> 7.5 OZ. 3 7/8" H., 2 3/4" W. JUICE CASE PACK: 4 DOZ. TRAEX RACK: TR-7C</p>	 <p><b>GL-9948</b> 11 OZ. 6 3/8" H., x 2 1/4" W. BEVERAGE CASE PACK: 4 DOZ. TRAEX RACK: TR-9EE</p>	 <p><b>GL-9949</b> 10 OZ., 7" H. 3" D. RED WINE CASE PACK: 2 DOZ. TRAEX RACK: TR-6BBB</p>	 <p><b>GL-9950</b> 12 OZ. 7 3/8" H., 3 1/2" W. GRAND VINO GOBLET CASE PACK: 2 DOZ. TRAEX RACK: TR-8DDDD</p>	 <p><b>GL-9951</b> 11 OZ., 7 7/8" H., 3 1/8" W. GRAND VINO WHITE WINE CASE PACK: 2 DOZ. TRAEX RACK: TR-8DD</p>	 <p><b>GL-9952</b> 13 OZ. 8 1/8" H., 3 1/4" D. STEM WATER CASE PACK: 2 DOZ. TRAEX RACK: TR-6BBB</p>	 <p><b>GL-9953</b> 16 OZ. 6 1/4" H., 3 3/8" W. COOLER CASE PACK: 2 DOZ. TRAEX RACK: TR-6BB</p>	 <p><b>GL-9955</b> 10.75 OZ. 4" H., 3 1/2" W. ROCKS GLASS CASE PACK: 2 DOZ. TRAEX RACK: TR-6B</p>
 <p><b>GL-9964</b> 14 OZ. 5 7/8" H., 3 1/2" W. MIXING CASE PACK: 2 DOZ. TRAEX RACK: TR-6BB</p>	 <p><b>GL-9975</b> 14 OZ. PILSNER GLASS CASE PACK: 4 DOZ. TRAEX RACK: TR-6BB</p>	 <p><b>GL-9976</b> 13 OZ., 5 7/8" H. 2 7/8" T. PILSNER GLASS CASE PACK: 4 DOZ. TRAEX RACK: TR-6BB</p>	 <p><b>GL-9978</b> 19 OZ. 5 7/8" H, 3 5/16" T, 2 5/8" B BEVERAGE GLASS CASE PACK: 4 DOZ. TRAEX RACK: TR-6BB</p>	 <p><b>GL-9979</b> 10 OZ. 4 3/8" H, 2 3/4" T, 2 1/16" B STOUT GLASS CASE PACK: 4 DOZ. TRAEX RACK: TR-7C</p>	 <p><b>GL-9982</b> 20 OZ., 6 1/2" H. 3 3/4" W. MIXING - RIM TEMPERED CASE PACK: 2 DOZ. TRAEX RACK: TR-6BBB</p>	 <p><b>GL-9984</b> 20 OZ. BILBAO GLASS CASE PACK: 1 DOZ. TRAEX RACK: TR-6BBB</p>	 <p><b>GL-9986</b> 22.5 OZ. 9" H, 3 3/8" W. PILSNER GLASS CASE PACK: 2 DOZ. TRAEX RACK: TR-6BBB</p>	 <p><b>GL-9995</b> 5.75 OZ. LEXINGTON GLASS CASE PACK: 2 DOZ. TRAEX RACK: TR-8D</p>
 <p><b>GL-9996</b> 20 OZ., 7 7/8" H. 3 1/8" D. ICED TEA CASE PACK: 2 DOZ. TRAEX RACK: TR-6BBB</p>	 <p><b>GL-9997</b> 12 OZ. TOSCANA GLASS CASE PACK: 2 DOZ. TRAEX RACK: TR-7CCC</p>	 <p><b>GL-9999</b> 10.5 OZ. 6" H., 3 1/8" W. PROVENZA GLASS CASE PACK: 3 DOZ. TRAEX RACK: TR-6BB</p>	 <p><b>GL-10001</b> 9.25 OZ. 6 1/2" H, 4 3/8" D. RIM TEMPERED MARTINI GLASS CASE PACK: 1 DOZ. TRAEX RACK: TR-8DD</p>	 <p><b>GL-10003</b> 10 OZ., 6" H., 4 1/2" D. RIM TEMPERED MARGARITA CASE PACK: 1 DOZ. TRAEX RACK: TR-8DD</p>	 <p><b>GL-10005</b> 11.5 OZ. 5.25" H., 3.5" W. BRANDY GLASS CASE PACK: 2 DOZ. TRAEX RACK: TR-6BB</p>	 <p><b>GL-10009</b> 8.5 OZ. 6 1/4" H., 2 3/4" W. ROJA GLASS CASE PACK: 2 DOZ. TRAEX RACK: TR-7CC</p>	 <p><b>GL-10011</b> 6 OZ. 8 1/8" H., 2 1/4" W. ROJA GLASS CASE PACK: 1 DOZ. TRAEX RACK: TR-7CCCC</p>	 <p><b>GL-10013</b> 10 OZ. 7 3/4" H., 2 3/4" W. VERSAILLES GLASS CASE PACK: 2 DOZ. TRAEX RACK: TR-7CCC</p>





































**GLASSWARE**

 <p><b>GL-10014</b> 8.5 OZ. 7 1/8" H., 2 1/2" W. VERSAILLES GLASS CASE PACK: 2 DOZ. TRAEX RACK: TR-7CCC</p>	 <p><b>GL-10016</b> 10 OZ., 3 1/4" H. 3 1/8" DIA., 2 7/8" B. MONTERREY ROCKS CASE PACK: 4 DOZ.</p>	 <p><b>GL-10017</b> 15 OZ., 5 5/8" H. 2 5/8" T., 2 3/8" B., 2 7/8" D. MONTERREY BEVERAGE CASE PACK: 4 DOZ.</p>	 <p><b>GL-10018</b> 16 OZ., 8 1/4" H. 3 1/4" T., 2 3/4" B., 3 1/4" D. HURRICANE GLASS CASE PACK: 1 DOZ.</p>	 <p><b>GL-10019</b> 9 OZ., 7" H., 4 1/2" T., 3" B., 4 1/2" D. MARTINI GLASS CASE PACK: 1 DOZ.</p>	 <p><b>GL-10020</b> 10.5 OZ., 8 1/2" H. 4 1/2" T., 3 1/4" B., 4 1/2" D. MARTINI GLASS CASE PACK: 1 DOZ.</p>	 <p><b>GL-10032</b> 15 OZ. 2 1/2" D. x 6 1/2" H. MANHATTAN BEVERAGE CASE PACK: 4 DOZ.</p>	 <p><b>GL-10033</b> 11.5 OZ. 3 1/4" D. x 3 7/8" H. MANHATTAN ROCKS CASE PACK: 4 DOZ.</p>	 <p><b>GL-10034</b> 15.5 OZ. 2 3/8" D. x 4 7/8" H. MIKONOS STEMLESS CASE PACK: 4 DOZ.</p>
 <p><b>GL-10038</b> 3 OZ., 4 7/8" H. x 2 1/4" D. 2" TD, 1 3/4" BD SHERRY/WINE TASTING CASE PACK: DOZ.</p>	 <p><b>GL-10040</b> 16 OZ., 5 3/4" H. 3 3/8" TD, 2 3/8" BD, MIXING \$000.00/ 2 DOZ.</p>	 <p><b>GL-10041</b> 1.5 OZ., 5 3/4" H. 2" TD, 1 3/8" BD, SHOTS \$000.00/ 6 DOZ.</p>	 <p><b>GL-10042</b> 1.75 OZ., 3 1/2" H., 2" TD, 1 3/8" BD, TEQUILA SHOT GLASS CASE PACK: 6 DOZ.</p>	 <p><b>GL-10050</b> 63 OZ., 8 3/4" H., 5 3/4" T., 4" B., 5 1/4" D. PITCHER CASE PACK: 1 DOZ.</p>	 <p><b>GL-10051</b> 27 OZ., 6 3/4" H., 3 7/8" T., 3 1/4" B., 4 1/8" D. PITCHER CASE PACK: 1 DOZ.</p>	 <p><b>GL-10052</b> 7 OZ., 5 8/3" H., 1 3/4" T., 2 1/2" B., 2 1/2" D. LONDON DECANT CASE PACK: 2 DOZ.</p>	 <p><b>GL-10054</b> 8 OZ., 2 3/4" H., 3 3/4" T., 2 3/4" B., 3 3/4" D. LEXINGTON DESSERT DISH CASE PACK: 2 DOZ.</p>	
 <p><b>GL-10053</b> 4 OZ., 3 1/3" H., 3 3/8" T., 2 5/8" B., 3 3/8" D. DESSERT SAMPLER CASE PACK: 6 DOZ.</p>	 <p><b>GL-10055</b> 8 OZ., 3 1/4" H., 4 1/4" T., 2 7/8" B., 4 1/4" D. FIESTA DESSERT DISH CASE PACK: 2 DOZ.</p>	 <p><b>GL-10057</b> 9 OZ., 6 5/8" H., 3 1/8" T. 3 1/8" B., 3 1/8" D. SODA GLASS CASE PACK: 2 DOZ.</p>	 <p><b>GL-10091</b> 20 OZ., 5 3/4" H. 3 1/4" BD MASON JAR CASE PACK: 2 DOZ.</p>	 <p><b>GL-10092</b> 13 OZ., 8 1/8" H. 2 3/4" TD FLARED PILSNER CASE PACK: 1 DOZ.</p>	 <p><b>GL-10093</b> 14 OZ. MIKONOS STEMLESS CASE PACK: 4 DOZ.</p>	 <p><b>GL-61600</b> 16 OZ., 5 8/10" H. 3 1/2" D. MIXING/BEER CASE PACK: 2 DOZ. TRAEX RACK: TR-6BB</p>	 <p><b>GL-78500</b> 14 OZ., 3.4" H. 2.6" TD, 3.7" MD ROCK CASE PACK: 4 DOZ.</p>	 <p><b>GL-78501</b> 14 OZ. 4.4" H., 2.6" TD, 3.2" MD HI BALL CASE PACK: 4 DOZ.</p>
 <p><b>GL-78502</b> 10 OZ., 6.3" H. 2.5" TD, 2.6" MD TEMPO CARAFE CASE PACK: 4 DOZ.</p>	 <p><b>GL-78503</b> 21 OZ., 6.3" H. 3.0" TD, 3.2" MD TEMPO CARAFE CASE PACK: 2 DOZ.</p>	 <p><b>GL-78708</b> 14 OZ., 5 3/4" H. 3 1/4" D. BEER/MIXING CASE PACK: 1 DOZ. TRAEX RACK: TR-6BB</p>	 <p><b>GL-78709</b> 16 OZ., 6" H. 3 1/4" D. BEER/MIXING CASE PACK: 2 DOZ. TRAEX RACK: TR-6BB</p>	 <p><b>GL-78800</b> 12.5 OZ., 7.5" H. 2.9" MD, BEVERAGE CASE PACK: 2 DOZ.</p>	 <p><b>GL-78801</b> 6 OZ., 8.1" H. 2.5" MD CHAMPAGNE FLUTE CASE PACK: 2 DOZ.</p>	 <p><b>GL-78802</b> 9 OZ., 5.9" H. 3.5" MD CHAMPAGNE CASE PACK: 2 DOZ.</p>	 <p><b>GL-78803</b> 7 OZ., 6.1" H. 2.9" MD WINE CASE PACK: 2 DOZ.</p>	 <p><b>GL-78804</b> 8.25 OZ., 6" H. 3" MD WINE CASE PACK: 2 DOZ.</p>
 <p><b>GL-78805</b> 10.75 OZ., 6.7" H. 3.25" MD WINE CASE PACK: 2 DOZ.</p>	 <p><b>GL-88100</b> 7 OZ., 4.7" H. 3.6" D. TULIP CHAMPAGNE CASE PACK: 4 DOZ. TRAEX RACK: TR-6B</p>	 <p><b>GL-88300</b> 20 OZ., 7 3/10" H. 2 3/4" D. ICED TEA CASE PACK: 2 DOZ. TRAEX RACK: TR-8DDD</p>	 <p><b>GL-88305</b> 20 OZ., 9 1/4" H. 3 1/2" D. ALL PURPOSE CASE PACK: 2 DOZ. TRAEX RACK: TR-6BBBB</p>	 <p><b>GL-88306</b> 15.5 OZ., 8.1" H. 3 1/2" D. WINE CASE PACK: 2 DOZ. TRAEX RACK: TR-6BBBB</p>	 <p><b>GL-88440</b> 1.75 OZ., 2.2" H. 2.0" MD SHOT CASE PACK: 6 DOZ.</p>	 <p><b>GL-88441</b> 6.75 OZ., 3.3" H. 3.2" MD ROCKS CASE PACK: 4 DOZ.</p>	 <p><b>GL-88442</b> 10.25 OZ., 3.8" H. 3.4" MD ROCKS CASE PACK: 4 DOZ.</p>	 <p><b>GL-88443</b> 10.25 OZ., 4.8" H. 3.0" MD DRINKING CASE PACK: 4 DOZ.</p>

















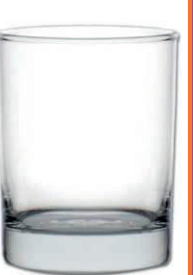















# GLASSWARE

 <p><b>GL-88444</b> 12.25 OZ., 5.9" H. 3.2" MD DRINKING CASE PACK: 4 DOZ.</p>	 <p><b>GL-88445</b> 5.5 OZ., 5.2" H. 2.75" MD WINE CASE PACK: 2 DOZ.</p>	 <p><b>GL-88446</b> 22 OZ., 7.9" H. 4.5" MD WINE CASE PACK: 2 DOZ.</p>	 <p><b>GL-88447</b> 2 OZ., 4.4" H. 2" MD PORT/TASTING CASE PACK: 2 DOZ.</p>	 <p><b>GL-88448</b> 8.25 OZ. 8" H. WINE CASE PACK: 2 DOZ.</p>	 <p><b>GL-88450</b> 6.5 OZ., 3.2" H. 4.2" MD STEMLESS MARTINI CASE PACK: 4 DOZ.</p>	 <p><b>GL-88451</b> 10.25 OZ., 6.5" H. 2.4" MD HI BALL CASE PACK: 4 DOZ.</p>	 <p><b>GL-88452</b> 12.25 OZ., 6.7" H. 2.5" MD HI BALL CASE PACK: 2 DOZ.</p>	 <p><b>GL-88453</b> 15.5 OZ. 7.7" H. HURRICANE CASE PACK: 2 DOZ.</p>	
 <p><b>GL-88454</b> 20 OZ., 7" H. 4" MD HURRICANE CASE PACK: 2 DOZ.</p>	 <p><b>GL-88455</b> 6.75 OZ., 3.3" H. 2.75" MD ROCKS CASE PACK: 2 DOZ.</p>	 <p><b>GL-88456</b> 8.5 OZ., 3.5" H. 2.9" MD ROCKS CASE PACK: 4 DOZ.</p>	 <p><b>GL-88457</b> 10.25 OZ., 3.7" H. 3.1" MD WHISKEY CASE PACK: 2 DOZ.</p>	 <p><b>GL-88460</b> 5 OZ., 2.2" H. 3.2" D. ROCKS CASE PACK: 4 DOZ. TRAEX RACK: TR-6B</p>	 <p><b>GL-88461</b> 12.25 OZ., 4.8" H. 3.3" D. DRINKING CASE PACK: 4 DOZ. TRAEX RACK: TR-6B</p>	 <p><b>GL-88463</b> 2.25 OZ. 2.5" H. SHOT GLASS CASE PACK: 2 DOZ.</p>	 <p><b>GL-88520</b> 7 OZ., 5 4/5" H. 3 1/4" D. WINE CASE PACK: 2 DOZ. TRAEX RACK: TR-6BB</p>	 <p><b>GL-88521</b> 9 OZ., 6 3/10" H. 3 2/5" D. WINE CASE PACK: 2 DOZ. TRAEX RACK: TR-6BB</p>	
 <p><b>GL-88522</b> 11 OZ., 7" H. 3 3/4" D. WINE CASE PACK: 2 DOZ. TRAEX RACK: TR-6BBB</p>	 <p><b>GL-88523</b> 7 3/4 OZ., 6 3/10" H. 2 3/4" D. WINE CASE PACK: 2 DOZ. TRAEX RACK: TR-7CC</p>	 <p><b>GL-88524</b> 8 1/4 OZ., 6 7/10" H. 3" D. WINE CASE PACK: 2 DOZ. TRAEX RACK: TR-6BBB</p>	 <p><b>GL-88525</b> 11 OZ., 7 1/10" H. 3 1/4" D. WINE CASE PACK: 2 DOZ. TRAEX RACK: TR-6BBB</p>	 <p><b>GL-88526</b> 13 OZ., 4 9/10" H. 3 3/5" D. COGNAC CASE PACK: 2 DOZ. TRAEX RACK: TR-10F</p>	 <p><b>GL-88527</b> 6 1/2 OZ., 5 3/10" H. 4 1/5" D. MARTINI CASE PACK: 2 DOZ. TRAEX RACK: TR-8DD</p>	 <p><b>GL-88528</b> 13 OZ., 6 3/10" H. 3 1/2" D. WATER CASE PACK: 2 DOZ.</p>	 <p><b>GL-88529</b> 6 OZ., 7 3/5" H. 2 2/5" D. CHAMPAGNE CASE PACK: 2 DOZ. TRAEX RACK: TR-7CCC</p>	 <p><b>GL-88530</b> 13 OZ., 6 2/5" H. 3 3/5" D. BEER CASE PACK: 2 DOZ. TRAEX RACK: TR-8DD</p>	
 <p><b>GL-88531</b> 2 OZ. SOLO SHOT GLASS CASE PACK: 6 DOZ. TRAEX RACK: TR-9</p>	 <p><b>GL-88590</b> 11.5 OZ. 8.2" H. WINE CASE PACK: 2 DOZ.</p>	 <p><b>GL-88591</b> 7.5 OZ. 9.1" H. CHAMPAGNE CASE PACK: 2 DOZ.</p>						 <p><b>AC-4194</b> 11 3/4 OZ. 5" H., 3 1/4" T. CREAMER/MINI PITCHER CASE PACK: SET/6</p>	 <p><b>WP-2510</b> 150 OZ. 8 3/4" X 4 3/4" PITCHER CASE PACK: SET/6</p>
<p><b>STEMLESS GLASSWARE COLLECTION (GLASS)</b></p>	 <p><b>GL-2200</b> 13.5 OZ., 3 1/2" H. 4 1/2" T., 1 5/8" B., 4 1/2" D. MARTINI CASE PACK: 1 DOZ. TRAEX RACK: TR-10FFF</p>	 <p><b>GL-2202</b> 16.75 OZ., 3 7/8" H. 3 1/8" T., 1 3/4" B., 3 7/8" D. RED WINE CASE PACK: 1 DOZ. TRAEX RACK: 8D</p>	 <p><b>GL-2203</b> 17 OZ., 4 1/2" H. 2 7/8" T., 2" B., 3 1/2" D. WHITE WINE CASE PACK: 1 DOZ. TRAEX RACK: TR-6B</p>	 <p><b>GL-2204</b> 8.5 OZ., 5 3/4" H. 1 3/4" T., 1 3/8" B., 2 1/4" D. FLUTE CASE PACK: 1 DOZ. TRAEX RACK: TR-9EE</p>	 <p><b>GL-2205</b> 11 3/4 OZ., 4" H. 2 3/8" T., 1 3/4" B., 3 1/4" D. WHITE WINE CASE PACK: 1 DOZ. TRAEX RACK: TR-6B</p>	<p><b>CREAMER/ PITCHER (LEAD FREE CRYSTAL)</b></p>	 <p><b>AC-4194</b> 11 3/4 OZ. 5" H., 3 1/4" T. CREAMER/MINI PITCHER CASE PACK: SET/6</p>	 <p><b>WP-2510</b> 150 OZ. 8 3/4" X 4 3/4" PITCHER CASE PACK: SET/6</p>	

**GLASSWARE**

<p><b>NEW ORLEANS GLASSWARE COLLECTION (CRYSTAL)</b></p>	 <p>GL-7720 12 OZ., 5 7/8" H., 3 1/8" DIA., 3 1/8" T., 2 1/4" B. COOLER CASE PACK: 3 DOZ.</p>	 <p>GL-7721 16 OZ., 6 3/8" H., 3 3/8" DIA., 3 3/8" T., 2 1/2" B. COOLER CASE PACK: 3 DOZ.</p>	 <p>GL-7727 9 OZ., 3 7/8" H., 3 1/2" DIA. ROCKS CASE PACK: 3 DOZ.</p>	 <p>GL-7729 9 OZ., 4 3/4" H., 3 1/8" DIA. HI-BALL CASE PACK: 3 DOZ.</p>	 <p>GL-7730 10 OZ., 4 3/4" H., 3 7/8" DIA. BEVERAGE CASE PACK: 3 DOZ.</p>	 <p>GL-7732 14 OZ., 5 1/8" H., 3 5/8" DIA., 3 1/2" T., 2 3/4" B. ICED TEA CASE PACK: 3 DOZ.</p>	 <p>GL-7733 22 OZ., 7" H., 3 3/4" DIA., 3 3/4" T., 2 3/4" B. ICED TEA CASE PACK: 2 DOZ.</p>	 <p>GL-7734 12 OZ., 3 3/8" DIA., 3 3/8" T., 2 3/4" B., 4 7/8" H. BEVERAGE CASE PACK: 2 DOZ.</p>
<p><b>BEER GLASSWARE COLLECTION (GLASS)</b></p>	 <p>GL-78700 14.5 OZ., 3.2" MD, 9.5" H. FOOTED BEER CASE PACK: 2 DOZ.</p>	 <p>GL-78701 24 OZ., 3.4" MD, 9.3" H. TALL BEER CASE PACK: 2 DOZ.</p>	 <p>GL-78702 16 OZ., 2.9" MD, 8.1" H. BEER CASE PACK: 2 DOZ.</p>	 <p>GL-78703 10 OZ., 3" MD, 5.9" H. PILSNER CASE PACK: 4 DOZ.</p>	<p><b>LALITA GLASSWARE COLLECTION (GLASS)</b></p>	 <p>GL-78900 10 OZ., 3.3" MD, 7.5" H. WINE CASE PACK: 2 DOZ.</p>	 <p>GL-78901 11.25 OZ., 3.3" MD, 8.2" H. WINE CASE PACK: 2 DOZ.</p>	 <p>GL-78902 13.5 OZ., 3.6" MD, 8.6" H. WINE CASE PACK: 2 DOZ.</p>
	 <p>GL-78704 12 OZ., 3.1" MD, 6.3" H. PILSNER CASE PACK: 4 DOZ.</p>	 <p>GL-78705 14 OZ., 3.3" MD, 6.7" H. PILSNER CASE PACK: 4 DOZ.</p>	 <p>GL-78706 11 OZ., 3.2" D, 6.8" H. PILSNER CASE PACK: 4 DOZ. TRAEX RACK: TR-6BB</p>	 <p>GL-78707 16 OZ., 2.9" D, 8.1" H. TALL BEER CASE PACK: 2 DOZ. TRAEX RACK: TR-7CCCC</p>		 <p>GL-78903 7 OZ., 2.9" MD, 9" H. CHAMPAGNE FLUTE CASE PACK: 2 DOZ.</p>	 <p>GL-78904 8.25 OZ., 3.2" H. STEMLESS WINE/MIX DRINK CASE PACK: 4 DOZ.</p>	 <p>GL-78905 16 OZ., 5.7" H. MIX DRINK CASE PACK: 4 DOZ.</p>
<p><b>COMFORT GLASSWARE COLLECTION (GLASS)</b></p>	 <p>GL-78300 16.5 OZ., 6.8" H. 2.75" TD, 3.5" MD GOBLET CASE PACK: 2 DOZ.</p>	 <p>GL-78301 RIESLING 10.5 OZ., 7.5" H. 2.4" TD, 3.0" MD CASE PACK: 2 DOZ.</p>	 <p>GL-78302 12.75 OZ., 7.8" H. 2.63" TD, 2.83" MD CHARDONNAY CASE PACK: 2 DOZ.</p>	<p><b>MADISON GLASSWARE COLLECTION (GLASS)</b></p>	 <p>GL-78950 10 OZ., 4.75" TD, 7.75" MD, 7.6" H., 3.4" FD COCKTAIL CASE PACK: 2 DOZ.</p>	 <p>GL-78951 7 OZ., 1.8" TD, 2.3" MD, 9.1" H., 32.7" FD CHAMPAGNE CASE PACK: 2 DOZ.</p>	 <p>GL-78952 22 OZ., 2.9" TD, 4.1" MD, 5.9" H., 2.9" FD COGNAC CASE PACK: 2 DOZ.</p>	 <p>GL-78953 15 OZ., 2.5" TD, 3.3" MD, 6.5" H., 3" FD GOBLET CASE PACK: 2 DOZ.</p>
	 <p>GL-78303 5.5 OZ., 8.5" H. 1.75" TD, 2.1" MD CHAMPAGNE CASE PACK: 2 DOZ.</p>	 <p>GL-78304 16.5 OZ., 8.21" H. 2.75" TD, 3.5" MD CABERNET CASE PACK: 2 DOZ.</p>	 <p>GL-78305 22.5 OZ., 8.2" H. 3.15" TD, 4.1" MD BURGUNDY CASE PACK: 2 DOZ.</p>		 <p>GL-78954 22 OZ., 3.2" TD, 4.3" MD, 8.25" H., 3.4" FD BURGUNDY CASE PACK: 2 DOZ.</p>	 <p>GL-78955 21 OZ., 2.9" TD, 4" MD, 8.9" H., 3.4" FD BORDEAUX CASE PACK: 2 DOZ.</p>	 <p>GL-78956 15 OZ., 2.5" TD, 3.3" MD, 8.9" H., 3.2" FD WINE CASE PACK: 2 DOZ.</p>	 <p>GL-78957 12 OZ., 2.4" TD, 3.1" MD, 8.25" H., 3.0" FD WINE CASE PACK: 2 DOZ.</p>

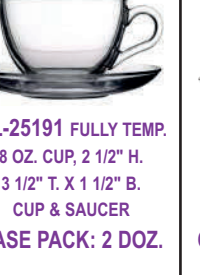
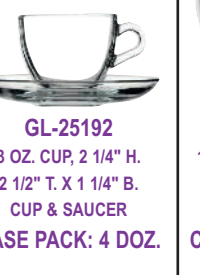
# GLASSWARE

<p><b>COFFEE SERVICE GLASSWARE COLLECTION (GLASS)</b></p>	 <p><b>GL-78600</b> 8.5 OZ., 3.1" H. 3.4" TD, 4.4" MD CAPPUCCINO CUP CASE PACK: 6 DOZ.</p>	 <p><b>GL-78601</b> 6" MD CAPPUCCINO SAUCER CASE PACK: 6 DOZ.</p>	 <p><b>GL-78602</b> 7.5 OZ., 2.5" H. 3.5" TD, 4.5" MD STACK CUP CASE PACK: 6 DOZ.</p>	 <p><b>GL-78603</b> 5 3/8" MD STACK SAUCER CASE PACK: 6 DOZ.</p>	<p><b>GRACIOUS GLASSWARE COLLECTION (GLASS)</b></p>	 <p><b>GL-78400</b> 8.5 OZ., 3.4" H. 2.9" TD ROCK CASE PACK: 6 DOZ.</p>	 <p><b>GL-78401</b> 11 OZ., 3.5" H. 3.0" TD ROCK CASE PACK: 6 DOZ.</p>	 <p><b>GL-78402</b> 13 OZ., 4.2" H. 3.3" TD ROCK CASE PACK: 4 DOZ.</p>
	 <p><b>GL-78604</b> 2.5 OZ., 2.2" H. 2.2" TD, 2.9" MD ESPRESSO CUP CASE PACK: 6 DOZ.</p>	 <p><b>GL-78605</b> 4.25" MD ESPRESSO SAUCER CASE PACK: 6 DOZ.</p>	 <p><b>GL-78606</b> 8 OZ., 5.8" H. 2.9" TD, 4" MD IRISH COFFEE CASE PACK: 2 DOZ.</p>	 <p><b>GL-78607</b> 11 OZ., 5.6" H. 2.9" TD, 4.2" MD SLIM MUG CASE PACK: 4 DOZ.</p>		 <p><b>GL-78608</b> 11 OZ., 4.1" H. 3.3" TD, 4.5" MD COFFEE MUG CASE PACK: 4 DOZ.</p>	 <p><b>GL-78403</b> 16 OZ., 6.6" H. 2.7" TD HI BALL CASE PACK: 4 DOZ.</p>	 <p><b>GL-78404</b> 10.25 OZ., 5.5" H. 2.4" TD HI BALL CASE PACK: 6 DOZ.</p>
<p><b>MARTINIS GLASSWARE COLLECTION (GLASS)</b></p>	 <p><b>GL-37491</b> 6 OZ. 5 3/4" H., 4 1/8" DIA. MARTINI CASE PACK: 3 DOZ.</p>	 <p><b>GL-37524</b> 4 1/2" OZ. 5 1/2" H., 3 7/8" DIA. MARTINI CASE PACK: 3 DOZ.</p>	 <p><b>GL-37525</b> 10 OZ. 6 3/4" H., 6 3/4" DIA. MARTINI CASE PACK: 1 DOZ.</p>	<p><b>BLISS GLASSWARE COLLECTION (GLASS)</b></p>	 <p><b>GL-88720</b> 12OZ., 6 7/10" H. 3" D. WATER CASE PACK: 2 DOZ. TRAEX RACK: TR-6BBB</p>	 <p><b>GL-88721</b> 26.25 OZ., 8.3" H. ? BORDEAUX CASE PACK: 2 DOZ. TRAEX RACK: TR-8DDDD</p>	 <p><b>GL-88722</b> 24 1/2 OZ., 8 3/10" H. 3" T., 4 1/2" M. BURGUNDY CASE PACK: 2 DOZ. TRAEX RACK: TR-10FFF</p>	 <p><b>GL-88723</b> 15 OZ., 8 4/5" H. 2 1/2" T., 3 1/2" M. CABERNET CASE PACK: 2 DOZ. TRAEX RACK: TR-6BBB</p>
	 <p><b>GL-2362</b> 10 OZ., 6 1/4" H. 3 7/8" T., 3 7/8" B., 4" M. SPECIALTY CASE PACK: 1 DOZ.</p>	 <p><b>GL-2366</b> 22 OZ., 8 9/16" H., 3" T. 3 3/8" B., 3 3/8" M. DAYTON MUG CASE PACK: 1 DOZ.</p>	 <p><b>GL-2371</b> 10 OZ., 5 7/8" H., 2 7/8" T. 3 1/4" B., 3 1/4" M. MUG CASE PACK: 1 DOZ.</p>		 <p><b>GL-88724</b> 6 OZ., 8 9/10" H. 2" T., 2 1/4" B., 3 1/4" M. CHAMPAGNE CASE PACK: 2 DOZ. TRAEX RACK: TR-7CCCC</p>	 <p><b>GL-88725</b> 8 1/2 OZ., 7 1/2" H. 2 3/10" T., 3" M. RIESLING CASE PACK: 2 DOZ. TRAEX RACK: TR-6BBBB</p>	 <p><b>GL-88726</b> 12 OZ., 8 2/5" H. 2 1/2" T., 3" M. CHARDONNAY CASE PACK: 2 DOZ. TRAEX RACK: TR-6BBBB</p>	
	 <p><b>GL-9904</b> 17 OZ., 5 7/8" H. 3 1/2" T., 2 3/8" B., 3 1/2" D. COOLER CASE PACK: 1 DOZ.</p>	 <p><b>GL-9906</b> 13 OZ., 3 3/4" H. 3 3/8" T., 3 3/8" B., 4 3/4" D. MUG CASE PACK: 1 DOZ.</p>	 <p><b>GL-9909</b> 1 1/2 OZ., 2 3/8" H. 2" T., 1 3/8" B., 2" D. WHISKEY CASE PACK: 6 DOZ.</p>		 <p><b>GL-25190</b> 8 1/2 OZ., 3/4" H. 3" T. X 2 3/4" B. STACKABLE COFFEE MUG CASE PACK: 2 DOZ.</p>	 <p><b>GL-25191 FULLY TEMP.</b> 8 OZ. CUP, 2 1/2" H. 3 1/2" T. X 1 1/2" B. CUP &amp; SAUCER CASE PACK: 2 DOZ.</p>	 <p><b>GL-25192</b> 3 OZ. CUP, 2 1/4" H. 2 1/2" T. X 1 1/4" B. CUP &amp; SAUCER CASE PACK: 4 DOZ.</p>	 <p><b>GL-8305</b> 16 OZ., 5" H., 5 1/4" DIA. 3 7/8" T., 3 1/4" B. CAFE MUG CASE PACK: 6 EACH</p>







































**BARWARE COLLECTION (GLASS)**

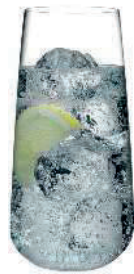

**BLUE GLASSWARE COLLECTION (GLASS)**

**GLASSWARE**

<p><b>TEMPTATION GLASSWARE COLLECTION (GLASS)</b></p>	 <p><b>GL-88820</b> 24 1/2 OZ., 8 3/10" H. 3" T., 4 1/2" M. BURGUNDY CASE PACK: 2 DOZ. TRAEX RACK: TR-10FFFF</p>	 <p><b>GL-88821</b> 20 1/2 OZ., 8 4/5" H. 2 1/2" T., 4" M. BORDEAUX CASE PACK: 2 DOZ TRAEX RACK: TR-8DDDD</p>	 <p><b>GL-88822</b> 16 1/2 OZ., 8 4/5" H. 2 1/2" T., 3 1/2" M. CABERNET CASE PACK: 2 DOZ TRAEX RACK: TR-6BBBB</p>	<p><b>SOUL GLASSWARE COLLECTION (GLASS)</b></p>	 <p><b>GL-88920</b> 10 OZ. DOUBLE ROCKS CASE PACK: 2 DOZ TRAEX RACK: TR-8D</p>	 <p><b>GL-88921</b> 9.5 OZ. HIGH BALL CASE PACK: 2 DOZ TRAEX RACK: TR-7CC</p>	 <p><b>GL-88922</b> 13.5 OZ. LONG DRINK CASE PACK: 2 DOZ TRAEX RACK: TR-6BB</p>	 <p><b>GL-88923</b> 9 OZ. ROCKS GLASS CASE PACK: 2 DOZ TRAEX RACK: TR-6B</p>
	 <p><b>GL-88823</b> 5 OZ., 9" H. 2" T., 2" M. CHAMPAGNE CASE PACK: 2 DOZ TRAEX RACK: TR-7CCCC</p>	 <p><b>GL-88824</b> 8 1/2 OZ., 7 2/5" H. 2" T., 3" M. RIESLING CASE PACK: 2 DOZ TRAEX RACK: TR-6BBBB</p>	 <p><b>GL-88825</b> 1 1/25 OZ., 8 1/5" H. 2 1/2" T., 3" M. CHARDONNAY CASE PACK: 2 DOZ TRAEX RACK: TR-6BBBB</p>		 <p><b>GL-88924</b> 23.75 OZ., 6.2" H. COGNAC CASE PACK: 2 DOZ. TRAEX RACK: TR-8DD</p>	 <p><b>GL-88925</b> 3.5 OZ., 7.6" H. GRAPPA CASE PACK: 2 DOZ TRAEX RACK: TR-7CCCC</p>	 <p><b>GL-88926</b> 2.75 OZ., 6.7" H. LIQUOR CASE PACK: 2 DOZ TRAEX RACK: TR-7CCCC</p>	 <p><b>GL-88927</b> 8 OZ., 7.1" H. MARTINI CASE PACK: 2 DOZ TRAEX RACK: TR-10FF</p>
<p><b>SAVOR GLASSWARE COLLECTION (GLASS)</b></p>	 <p><b>GL-78100</b> 11.75 OZ., 3.2" MD, 8.3" H. CHARDONNAY CASE PACK: 2 DOZ.</p>	 <p><b>GL-78101</b> 24 OZ., 4.4" MD, 8.5" H BURGUNDY CASE PACK: 2 DOZ.</p>	 <p><b>GL-78102</b> 14.25 OZ., 3.4" MD, 8.7" H. CABERNET CASE PACK: 2 DOZ.</p>	 <p><b>GL-78103</b> 5.5 OZ., 2.1" MD, 8.7" H. CHAMPAGNE CASE PACK: 2 DOZ.</p>	 <p><b>GL-78104</b> 20 OZ., 3.8" MD, 8.9" H. BORDEAUX CASE PACK: 2 DOZ.</p>	<p><b>MINI MIXOLOGY (GLASS)</b> THIS SAMPLER GLASS IS PART OF THE MINI MIXOLOGY COLLECTION AND YOUR GUESTS WILL FALL IN LOVE WITH IT! GREAT FOR DRINK SAMPLERS, DESSERTS, OR A UNIQUE PRESENTATION WITH DINNER. SOLD IN CASE PACKS ONLY.</p>	 <p><b>GL-25120</b> 6 OZ., 3 1/2" H. 2 1/2" T., 2 1/2" B. SAMPLER, FULLY TEMPERED CASE PACK: 4 DOZ.</p>	 <p><b>GL-25123</b> 6 1/2 OZ., 3 3/4" H. 3/4" T., 2" B. SAMPLER CASE PACK: 6 DOZ.</p>
	 <p><b>GL-78105</b> 13 OZ., 7.0" H., 3.0" MD, BEVERAGE CASE PACK: 2 DOZ.</p>	 <p><b>GL-78106</b> 8 OZ., 4.7" MD, 6.5" H. MARTINI CASE PACK: 2 DOZ.</p>	 <p><b>GL-78107</b> 12.5 OZ., 3.6" MD, 3.4" H. DOUBLE ROCK CASE PACK: 2 DOZ.</p>	 <p><b>GL-78108</b> 15.5 OZ., 3.4" MD, 3.9" H. STEMLESS CABERNET CASE PACK: 2 DOZ.</p>	 <p><b>GL-78109</b> 14.25 OZ., 3.1" MD, 4.8" H. STEMLESS CHARDONNAY CASE PACK: 2 DOZ.</p>		 <p><b>GL-25124</b> 5 OZ., 3 3/4" H. 2 1/2" T., 2 1/4" B. SAMPLER CASE PACK: 2 DOZ.</p>	 <p><b>GL-25126</b> 7 1/4 OZ., 5 1/2" H. 2 1/2" T., 2 1/2" B. SAMPLER CASE PACK: 4 DOZ.</p>
<p><b>MIRAGE (LEAD-FREE CRYSTAL)</b> THIS GLASS IS PART OF THE MIRAGE COLLECTION AND YOUR GUESTS WILL FALL IN LOVE WITH THE UNIQUE STYLE OF THE GLASS!</p>	 <p><b>GL-25130</b> 26 1/2 OZ., 8 1/2" H. 3 1/4" T. RED WINE CASE PACK: 1 DOZ</p>	 <p><b>GL-25131</b> 19 1/2 OZ., 8 1/4" H. 3" T. RED WINE CASE PACK: 1 DOZ</p>	 <p><b>GL-25132</b> 14 1/2 OZ., 7 3/4" H. 2 3/4" T. WHITE WINE CASE PACK: 1 DOZ</p>	 <p><b>GL-25133</b> 8 1/4 OZ., 9 1/4" H. 1 3/4" T. CHAMPAGNE CASE PACK: 1 DOZ</p>	 <p><b>GL-25134</b> 16 1/4 OZ., 6" H. 1/4" T. HIGH BALL CASE PACK: 2 DOZ</p>	 <p><b>GL-25135</b> 10 OZ., 5 1/2" H. 2" T. HIGH BALL CASE PACK: 2 DOZ</p>	 <p><b>GL-25136</b> 13.5 OZ., 3 1/4" H. 2 3/4" T. WHISKY CASE PACK: 16 EA.</p>	 <p><b>AC-4195</b> 7 OZ., 3 1/2" H. 3 1/4" T. x 2" B. GLASS CREAMER CASE PACK: 1 DOZ.</p>

**GLASSWARE**

<p><b>CRAFT BEER GLASSES</b></p> <p>THIS CRAFT BEER COLLECTION OFFERS UNIQUE OPTIONS TO SERVE COLD BEER. GREAT FOR BREWERIES, FOOD PAIRING, AND SPECIALTY BREW POURS</p>	 <p><b>GL-25160</b> 13 OZ., 7" H. 3 1/4" T., 2 1/2" B. CRAFT BEER CASE PACK: 1 DOZ</p>	 <p><b>GL-25163</b> 19 OZ., 8 1/4" H. 3" T., 3" B. CRAFT BEER CASE PACK: 2 DOZ</p>	 <p><b>GL-25164</b> 16 OZ., 8" H., 2 3/4" T., 3" B. CRAFT BEER CASE PACK: 2 DOZ</p>	<p><b>DIONY COLLECTION</b></p> 	 <p><b>GL-25150</b> 10 1/4 OZ., 7 1/4" H. 3 3/4" T., 2 3/4" B. COCKTAIL GLASS - LARGE CASE PACK: 1 DOZ</p>	 <p><b>GL-25151</b> 7 3/4 OZ., 6 1/2" H., 3 1/4" T., 2 1/2" B. COCKTAIL CASE PACK: 1 DOZ</p>	 <p><b>GL-25152</b> 4 1/4 OZ., 8 1/4" T. 2 1/4" T., 2 1/4" B. CHAMPAGNE FLUTES CASE PACK: 1 DOZ</p>	 <p><b>GL-25153</b> 14 3/4 OZ., 5 3/4" H. 2 3/4" T., 2 3/4" B. BEVERAGE CASE PACK: 4 DOZ</p>
 <p><b>GL-25165</b> 13 OZ., 7 1/2" H. 2 1/2" T., 2 3/4" B. CRAFT BEER CASE PACK: 2 DOZ</p>	 <p><b>GL-25167</b> 9 1/2 OZ., 6 1/2" H. 2 1/2" T., 2 1/2" B. CRAFT BEER CASE PACK: 2 DOZ</p>	 <p><b>GL-25168</b> 16 OZ., 6 1/2" H., 2 1/2" T. 2 1/2" B., FULLY TEMPERED CRAFT ELEGIAN BEER CASE PACK: 2 DOZ</p>	 <p><b>GL-25169</b> 13 1/2 OZ., 5" H. 3 1/4" T., 2 2/8" B. CRAFT BEER HIGH ABV CASE PACK: 2 DOZ</p>	 <p><b>GL-25154</b> 9 3/4 OZ., 5 1/4" H., 2 1/2" T., 2 1/4" B. HI BALL CASE PACK: 4 DOZ</p>	 <p><b>GL-25155</b> 10 1/2 OZ., 3 1/2" H., 3 1/4" T., 3 1/4" B. ROCK GLASS- LARGE CASE PACK: 4 DOZ</p>	 <p><b>GL-25156</b> 8 1/4 OZ., 3" H. 3" T., 2 3/4" B. ROCK GLASS CASE PACK: 4 DOZ</p>	 <p><b>GL-25157</b> 10 3/4 OZ., 3 3/4" H. 3 1/2" T., 1 3/4" B. WHISKEY CASE PACK: 2 DOZ</p>	 <p><b>GL-25158</b> 11 1/2 OZ., 5 1/2" H. 3" T., 1 1/2" B. HI-BALL CASE PACK: 2 DOZ</p>
 <p><b>GL-25170</b> 16 OZ., 5 1/2" H., 3 1/2" T., 2 3/8" B. CRAFT BEER IPA CASE PACK: 2 DOZ</p>	 <p><b>GL-25171</b> 20 OZ., 3 1/2" T., 2 3/4" B. 6" H., FULLY TEMPERED ENGLISH BITTERS/STOUT CASE PACK: 4 DOZ</p>	 <p><b>GL-25172</b> 12 1/4 OZ., 6 1/2" H. 2 1/2" T., 2 3/4" B. BEER IPA CASE PACK: 1 DOZ</p>	 <p><b>GL-25173</b> 15 3/4 OZ., 7 3/4" H. 3 1/4" T., 3 1/4" B. CRAFT BEER CASE PACK: 1 DOZ</p>	<p><b>PEARLS GLASSWARE</b></p> 	 <p><b>GL-3420</b> 13 OZ., 5" H. 3 1/2" T., 2 1/4" B. HI BALL CASE PACK: 16 EA.</p>	 <p><b>GL-3421</b> 10 OZ., 4" H. 3 1/4" T., 2 1/4" B. ROCKS CASE PACK: 16 EA.</p>	 <p><b>GL-3422</b> 11 OZ., 6 1/2" H. 3 1/2" T., 3" B. BEVERAGE CASE PACK: 16 EA.</p>	 <p><b>GL-3423</b> 10 OZ., 4 1/4" H. 4 3/4" T., 3" B. DESSERT BOWL CASE PACK: 16 EA.</p>
 <p><b>GL-25174</b> 23 OZ., 9 1/4" H. 3 1/4" T., 3" B. CRAFT BEER GERMAN CASE PACK: 1 DOZ</p>	 <p><b>GL-25175</b> 10 3/4 OZ., 10 3/4" H., 3 1/4" T., 2 1/4" B. CRAFT BEER CASE PACK: 2 DOZ</p>	 <p><b>GL-4560</b> 5 OZ., 4" H., 2 1/2" DIA. 2 1/4" T., 1 3/4" B. BEER TASTING GLASS CASE PACK: 2 DOZ.</p>	 <p><b>AC-4561</b> 5/8" H., 14 1/2" L. HOLDS 4 - GL-4560 SERVING PADDLE HOLDS CASE PACK: 1 DOZ.</p>	<p><b>LINE WHISKEY SHOT GLASSWARE COLLECTION (GLASS)</b></p>	 <p><b>GL-1130</b> 1 1/4 OZ. - 1/2 OZ., 2 7/8" H. 2 1/4" DIA., 2 1/4" T., 1 3/4" B. LINE WHISKEY SHOT CASE PACK: 6 DOZ.</p>	 <p><b>GL-1131</b> 1 1/2 OZ. - 3/4 OZ., 2 7/8" H. 2 1/4" DIA., 2 1/4" T., 1 3/4" B. LINE WHISKEY SHOT CASE PACK: 4 DOZ.</p>	 <p><b>GL-1132</b> 1 1/2 OZ. - 7/8 OZ., 2 7/8" H. 2 1/4" DIA., 2 1/4" T., 1 3/4" B. LINE WHISKEY SHOT CASE PACK: 4 DOZ.</p>	 <p><b>GL-1133</b> 2 OZ. - 1 OZ., 2 7/8" H. 2 1/4" DIA., 2 1/4" T., 1 3/4" B. LINE WHISKEY SHOT \$137.75/ 4 DOZ.</p>
<p><b>MASON JAR (GLASS)</b></p>	 <p><b>GL-92144</b> 4 OZ., 3 5/8" H., 1 3/4" T. 1 5/8" B. x 2" D. MASON JAR CASE PACK: 2 DOZ.</p>	 <p><b>GL-92104</b> 8 OZ., 4 1/4" H. 2 1/8" T. x 2" B. x 2 3/8" D. MASON JAR CASE PACK: 1 DOZ.</p>	 <p><b>GL-92103</b> 16 OZ., 5 1/4" H., 2 5/8" T. 2 1/2" B. x 2 1/8" D. MASON JAR CASE PACK: 1 DOZ.</p>	 <p><b>GL-92105</b> 24 OZ., 6 1/8" H. x 3" T. 2 3/4" B. x 3 3/8" D. MASON JAR CASE PACK: 1 DOZ.</p>	 <p><b>GL-92110</b> 32 OZ., 6 3/4" H. x 3 1/2" T. 3 1/2" B. x 3 3/4" D. MASON JAR CASE PACK: 1 DOZ.</p>	 <p><b>LD-92136</b> LID FOR GL-92103 ONLY GOLD METAL LID CASE PACK: 6 DOZ.</p>	 <p><b>LD-92159</b> LID FOR GL-92110 ONLY SILVER METAL LID CASE PACK: 3 DOZ.</p>	

**GLASSWARE**



**EXCALIBUR  
GLASSWARE  
COLLECTION  
(GLASS)**



**GL-70014**  
7.5 OZ., 6 3/4" H., 4 1/2" T.  
3 1/16" B., 4 1/2" M.  
COCKTAIL  
CASE PACK: 1 DOZ.



**GL-3015442**  
12 OZ.  
6 5/8" H., 4 5/8" T., 3" B  
MARGARITA  
CASE PACK: 1 DOZ.



**GL-8020864**  
16 OZ.  
6" H., 3 1/8" T., 2 1/8" B.  
BEVERAGE  
CASE PACK: 3 DOZ.



**GL-8020865**  
12.5 OZ., 5 11/16" H.  
2 7/8" T., 2" B.  
BEVERAGE  
CASE PACK: 3 DOZ.



**GL-8020866**  
11 OZ.  
5 1/4" H., 2 7/8" T., 2" B.  
HI BALL  
CASE PACK: 3 DOZ.  
TRAEX RACK: TR-?



**GL-8020868**  
9 OZ., 4 3/4" H.  
2 11/16" T., 1 7/8" B.  
HI BALL  
CASE PACK: 3 DOZ.



**GL-8020874**  
9 OZ., 3 1/4" H.  
3 1/4" T., 2 5/16" B.  
OLD FASHIONED  
CASE PACK: 3 DOZ.



**GL-8020875**  
7 OZ., 3 1/16" H.  
3" T., 2 1/8" B.  
OLD FASHIONED  
CASE PACK: 3 DOZ.



**GL-8022760**  
5 OZ., 6" H.  
3 3/4" T., 2 3/4" B.  
COCKTAIL  
CASE PACK: 3 DOZ.



**GL-8051752**  
15.5 OZ., 8 1/4" H.  
3 1/4" T., 3" B.  
GRAND SAVOIE  
CASE PACK: 2 DOZ.



**GL-8071074**  
10 OZ., 7 7/16" H.  
4 3/4" T., 3" B.  
MARTINI GLASS  
CASE PACK: 1 DOZ.



**GL-8071076**  
11 OZ., 6 1/8" H.  
2 1/2" T., 3" B.  
ALL PURPOSE GOBLET  
CASE PACK: 3 DOZ.



**GL-8071078**  
11.5 OZ., 5 1/4" H.  
3" T., 2 7/8" B.  
BANQUET GOBLET  
CASE PACK: 3 DOZ.



**GL-8071079**  
12 OZ., 5" H.  
2 3/8" T., 2 7/8" B.  
BRANDY  
CASE PACK: 3 DOZ.



**GL-8071080**  
12 OZ., H:7 1/2" H.  
3" T., 3" B., 3 3/8" M.  
GRAND SAVOIE  
CASE PACK: 2 DOZ.



**GL-8071081**  
13 OZ., 8 1/8" H.  
2 3/4" T., 3" B.  
GRAND CUVÉE  
CASE PACK: 2 DOZ.



**GL-8071082**  
8.5 OZ., 6 1/8" H.  
2 7/8" T., 2 3/4" B.  
BALLON WINE  
CASE PACK: 3 DOZ.



**Z-STEM  
GLASSWARE  
COLLECTION  
(GLASS)**



**GL-35400**  
12 OZ.  
7" H., 4 1/2" T., 2 7/8" B.  
4 1/2" D.  
MARGARITA  
CASE PACK: 1 DOZ.



**GL-35401**  
5 OZ., 5 3/8" H., 3 7/8" T.  
2 3/4" B., 3 7/8" D.  
MARTINI  
CASE PACK: 1 DOZ.



**GL-35402**  
7.5 OZ., 6 3/8" H., 4 1/4" T.  
3" B., 4 1/4" D.  
MARTINI  
CASE PACK: 1 DOZ.



**GL-35403**  
9.25 OZ., 6 1/2" H.  
4 3/8" T., 3" B., 4 3/8" D.  
MARTINI  
CASE PACK: 1 DOZ.



**GL-35404**  
13.5 OZ., 7 5/8" H.  
3" T., 2 7/8" B., 3 5/8" D.  
POCO GRANDE  
CASE PACK: 1 DOZ.



**GL-35406**  
6 OZ., 8 1/8" H.  
2" T., 2 3/4" B., 2 3/4" D.  
FLUTE  
CASE PACK: 1 DOZ.

**CLARISSE  
GLASSWARE  
COLLECTION  
(GLASS)**



**GL-1134**  
7 OZ., 3 3/8" H., 3 1/4" DIA.  
3 1/4" T., 2 3/4" B.  
ROCKS  
\$127.75/ 3 DOZ.



**GL-1135**  
8 OZ., 3 3/8" H., 3 1/4" DIA.  
3 1/4" T., 2 3/4" B.  
ROCKS  
\$129.00/ 3 DOZ.



**GL-1136**  
10 OZ., 3 1/2" DIA., 3 1/2" T.  
2 3/8" B., 3 3/4" H.  
ROCKS  
\$137.75/ 3 DOZ.



**GL-1137**  
12 OZ., 3 5/8" DIA.  
3 5/8" T., 2 1/2" B., 4" H.  
ROCKS  
CASE PACK: 3 DOZ.



**GL-1138**  
9 OZ., 3" DIA.  
3" T., 2 1/2" B., 4 1/2" H.  
HI-BALL  
CASE PACK: 3 DOZ.



**GL-1139**  
12 OZ., 3 1/4" DIA., 3 1/4" T.  
2 1/4" B., 4 7/8" H.  
BEVERAGE  
CASE PACK: 3 DOZ.



**GL-1140**  
14 OZ., 3 3/8" DIA., 3 3/8" T.  
2 1/4" B., 5 1/8" H.  
BEVERAGE  
CASE PACK: 3 DOZ.



**GL-8071083**  
10.5 OZ., 7 1/4" H.  
2 5/8" T., 3" B.  
GOBLET  
CASE PACK: 3 DOZ.



**GL-8071084**  
8.5 OZ., 6 3/4" H.  
2 5/8" T., 2 3/4" B.  
TALL WINE  
CASE PACK: 3 DOZ.



**GL-8071086**  
8.5 OZ., 6 3/4" H.  
2 5/8" T., 2 3/4" B.  
FLUTE  
CASE PACK: 3 DOZ.



**GL-8071092**  
8 OZ., 5 3/8" H.  
2 3/4" T., 2 5/8" B.  
FOOTED HI BALL  
CASE PACK: 3 DOZ.



**GL-8071093**  
13 OZ., 7" H.  
2 3/4" T., 3" B.  
PETITE CUVÉE  
CASE PACK: 2 DOZ.



**GL-1141**  
16 OZ., 3 3/8" DIA., 3 3/8" T.  
2 1/8" B., 6 1/8" H.  
COOLER  
CASE PACK: 3 DOZ.



**GL-1142**  
20 OZ., 3 3/4" DIA.  
3 3/4" T., 2 3/8" B., 6 1/2" H.  
COOLER  
CASE PACK: 2 DOZ.



**GL-1143**  
10 OZ., 4 7/8" DIA.  
2 7/8" T., 3 1/4" B., 5 7/8" H.  
BEER TANKARD  
CASE PACK: 1 DOZ.



**GL-1144**  
12 OZ., 4 7/8" DIA., 2 7/8" T.  
3 1/4" B., 5 7/8" H.  
BEER TANKARD  
CASE PACK: 1 DOZ.

# GLASSWARE



EMBASSY  
GLASSWARE  
COLLECTION  
(GLASS)

 <p><b>GL-2395</b> 8.75 OZ., 7" H. 2 1/4" T., 2 3/4" Bx2 3/4" D. WINE CASE PACK: 2 DOZ.</p>	 <p><b>GL-2396</b> 8 3/4 OZ., 6 3/8" H. 2 3/4" T., 2 3/4" Bx3 1/8" D. WINE CASE PACK: 2 DOZ.</p>	 <p><b>GL-2397</b> 3 OZ., 3 3/4" H. 3 1/8" T., 2 1/8" Bx3 1/8" D. MINI MARTINI CASE PACK: 1 DOZ.</p>	 <p><b>GL-2398</b> 16 OZ., 7 5/8" H. 2 3/4" T., 2 3/4" Bx3 1/8" D. PILSNER CASE PACK: 1 DOZ.</p>	 <p><b>GL-2400</b> 1 1/4 OZ., 4 1/8" H. 1 1/4" T., 1 3/4" Bx1 3/4" D. CORDIAL CASE PACK: 3 DOZ.</p>	 <p><b>GL-2401</b> 1 OZ., 4 1/4" H. 1 5/8" T., 1 5/8" Bx1 5/8" D. CORDIAL CASE PACK: 1 DOZ.</p>	 <p><b>GL-2402</b> 2 OZ., 4 1/4" H. 1 3/8" T., 1 3/4" Bx1 5/8" D. BRANDY CASE PACK: 1 DOZ.</p>	 <p><b>GL-2403</b> 3 OZ., 4 7/8" H. 2 1/8" T., 2 3/8" Bx2 3/8" D. SHERRY CASE PACK: 1 DOZ.</p>
 <p><b>GL-2404</b> 4 1/2 OZ., 5 3/4" H. 2" T., 2 3/8" Bx2 3/8" D. WHISKEY SOUR CASE PACK: 3 DOZ.</p>	 <p><b>GL-2405</b> 4 1/2 OZ., 5 1/8" H. 2 7/8" T., 2 1/2" Bx2 7/8" D. COCKTAIL CASE PACK: 3 DOZ.</p>	 <p><b>GL-2407</b> 4 1/2 OZ., 4 1/4" H. 3 1/4" T., 2 3/4" Bx3 3/8" D. CHAMPAGNE CASE PACK: 3 DOZ.</p>	 <p><b>GL-2408</b> 5 1/2 OZ., 4 1/2" H. 3 1/4" T., 2 3/4" B., 3 3/8" D. CHAMPAGNE CASE PACK: 3 DOZ. TRAEX RACK: TR-6B</p>	 <p><b>GL-2409</b> 6 1/2 OZ., 5 3/8" H. 2 5/8" T., 2 1/2" Bx2 2/8" D. WINE CASE PACK: 2 DOZ.</p>	 <p><b>GL-2410</b> 8 1/2 OZ., 5 5/8" H. 2 7/8" T., 2 3/4" Bx3 1/8" D. WINE CASE PACK: 2 DOZ.</p>	 <p><b>GL-2411</b> 10 1/2 OZ., 6" H. 3 1/8" T., 2 3/4" Bx3 3/8" D. WINE CASE PACK: 3 DOZ.</p>	 <p><b>GL-2412</b> 6 1/2 OZ., 6 1/4" H. 2 1/8" T., 2 5/8" Bx2 5/8" D. WINE CASE PACK: 3 DOZ.</p>
 <p><b>GL-2413</b> 8 1/2 OZ., 6 3/8" H. 2 3/8" T., 2 1/4" Bx2 3/4" D. WINE CASE PACK: 2 DOZ.</p>	 <p><b>GL-2414</b> 4 1/2 OZ., 7 3/8" H. 1 3/4" T., 2 3/4" Bx2 1/2" D. FLUTE CASE PACK: 1 DOZ.</p>	 <p><b>GL-2415</b> 6 OZ., 8 1/8" H. 2" T., 2 3/4" Bx2 1/2" D. FLUTE CASE PACK: 1 DOZ.</p>	 <p><b>GL-2416</b> 5 1/2 OZ., 4 1/8" H. 2 T., 2 3/8" Bx2 7/8" D. BRANDY CASE PACK: 1 DOZ.</p>	 <p><b>GL-2417</b> 9 OZ., 4 1/2" H. 2 1/4" T., 2 1/2" Bx3 3/8" D. BRANDY CASE PACK: 2 DOZ.</p>	 <p><b>GL-2418</b> 11 1/2 OZ., 5" H. 2 1/4" T., 2 3/4" Bx3 5/8" D. BRANDY CASE PACK: 2 DOZ.</p>	 <p><b>GL-2419</b> 17 1/2 OZ., 5 1/2" H. 2 5/8" T., 2 3/4" Bx4" D. BRANDY CASE PACK: 2 DOZ.</p>	 <p><b>GL-2420</b> 22 OZ., 6" H. 2 3/4" T., 2 7/8" Bx4 3/8" D. BRANDY CASE PACK: 1 DOZ.</p>
 <p><b>GL-2421</b> 5 OZ., 5 1/4" H. 3 3/4" T., 2 3/4" Bx3 3/4" D. COCKTAIL CASE PACK: 3 DOZ.</p>	 <p><b>GL-2422</b> 7 1/2 OZ., 6 3/8" H. 4 1/4" T., 3" Bx4 1/4" D. MARTINI CASE PACK: 1 DOZ.</p>	 <p><b>GL-2423</b> 9 1/4 OZ., 6 1/2" H. 4 3/8" T., 3" Bx4 3/8" D. MARTINI CASE PACK: 1 DOZ.</p>	 <p><b>GL-2425</b> 5 1/2 OZ., 4 1/8" H. 3 1/8" T., 2 3/4" Bx3 1/8" D. FOOTED ROCKS CASE PACK: 2 DOZ.</p>	 <p><b>GL-2426</b> 7 OZ., 4 3/8" H. 3 1/4" T., 2 3/4" Bx3 1/4" D. FOOTED ROCKS CASE PACK: 2 DOZ.</p>	 <p><b>GL-2427</b> 8 OZ., 5 3/8" H. 2 3/4" T., 2 3/4" Bx2 7/8" D. FOOTED HI BALL CASE PACK: 2 DOZ.</p>	 <p><b>GL-2428</b> 10 OZ., 6" H. 2 7/8" T., 2 3/4" Bx2 7/8" D. FOOTED HI BALL CASE PACK: 2 DOZ.</p>	 <p><b>GL-2429</b> 12 OZ., 7 1/8" H. 2 1/2" T., 2 3/4" Bx2 3/4" D. BEER CASE PACK: 3 DOZ.</p>
 <p><b>GL-2430</b> 10 OZ., 6 3/4" H. 2 3/8" T., 2 3/4" Bx2 3/4" D. BEER CASE PACK: 2 DOZ.</p>	 <p><b>GL-2431</b> 12 OZ., 7 1/8" H. 2 1/2" T., 2 3/4" Bx2 7/8" D. BEER CASE PACK: 2 DOZ.</p>	 <p><b>GL-2432</b> 14 OZ., 7 3/8" H. 2 1/2" T., 2 3/4" Bx3" D. BEER CASE PACK: 2 DOZ.</p>	 <p><b>GL-2433</b> 10 1/2 OZ., 5 1/4" H. 2 7/8" T., 2 7/8" Bx3 1/8" D. BANQUET GOBLET CASE PACK: 2 DOZ.</p>	 <p><b>GL-2434</b> 10 1/2 OZ., 5 3/4" H. 3" T., 2 3/4" Bx3" D. GOBLET CASE PACK: 2 DOZ.</p>	 <p><b>GL-2435</b> 11 1/2 OZ., 6 1/8" H. 2 7/8" T., 2 3/4" Bx3 1/4" D. GOBLET CASE PACK: 2 DOZ.</p>		



**GLASSWARE**



**HELENA  
COLLECTION  
(LEAD FREE  
CRYSTAL)**



**GL-11000**  
21 OZ.  
BORDEAUX  
CASE PACK: 1 DOZ.



**GL-11001**  
19 OZ.  
CABERNET  
CASE PACK: 1 DOZ.



**GL-11002**  
16 OZ.  
ALL PURPOSE  
CASE PACK: 1 DOZ.



**GL-11003**  
12 OZ.  
CHARDONNAY  
CASE PACK: 2 DOZ.



**GL-11004**  
9 OZ.  
ALL PURPOSE  
CASE PACK: 2 DOZ.



**GL-11005**  
7 OZ.  
TASTER  
CASE PACK: 2 DOZ.



**GL-11006**  
6 OZ.  
TASTER  
CASE PACK: 2 DOZ.



**GL-11007**  
4 OZ.  
SAMPLER  
CASE PACK: 4 DOZ.



**GL-11008**  
2 OZ.  
SAMPLER  
CASE PACK: 4 DOZ.



**GL-11009**  
15 OZ.  
WATER GOBLET  
CASE PACK: 2 DOZ.



**GL-11010**  
7.5 OZ.  
CHAMPAGNE FLUTE  
CASE PACK: 3 DOZ.



**GL-11011**  
1/2 LITER (15 OZ.)  
DECANTER  
CASE PACK: 2 DOZ.



**GL-11012**  
1/4 LITER (8 OZ.)  
CARAFE  
CASE PACK: 2 DOZ.

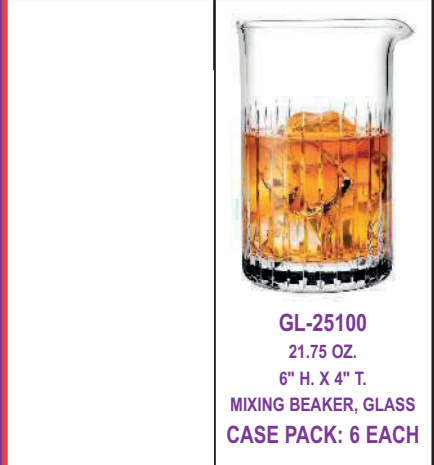

**GL-25101**  
5.25 OZ.  
5" H. X 1 1/4"  
BITTERS BOTTLE, GLASS  
CASE PACK: 6 EACH



**GL-25102**  
36 3/4 OZ.  
6 3/4" H. X 2 1/2" T.  
WHISKEY BOTTLE ONLY  
CASE PACK: 1 EACH



**GL-25103**  
8 OZ.  
5 3/4" T. X 1 1/4" T.  
COUPE CHAMPAGNE  
CASE PACK: 1 DOZ.



**GL-25104**  
7 OZ.  
6 1/4" H. X 3 3/4" T.  
COUPE CHAMPAGNE  
CASE PACK: 1 DOZ.



**GL-25105**  
20 1/2 OZ.  
9 1/4" H. X 4 1/2" T.  
COCKTAIL  
CASE PACK: 1 DOZ.



**GL-25106**  
1 OZ.  
4 1/4" H. X 2 1/4" T.  
WHISKEY TASTING  
CASE PACK: 2 DOZ.



**GL-25107**  
19 1/2 OZ.  
7" H. X 3 1/4" T.  
GIN & TONIC  
CASE PACK: 2 DOZ.

**MIXOLOGY  
(LEAD FREE  
CRYSTAL)**



**GL-25108**  
22 3/4 OZ.  
8 1/4" H. X 3 1/2" T.  
GIN & TONIC  
CASE PACK: 2 DOZ.



**GL-25109**  
4 OZ.  
4" H. X 2" T.  
TEQUILA  
CASE PACK: 2 DOZ.



**GL-25110**  
5 OZ.  
4 3/4" H. X 2" T.  
SAKE,  
CASE PACK: 2 DOZ.



**GL-25111**  
6 OZ.  
4 3/4" H. X 1 3/4" T.  
PROSECCO  
CASE PACK: 2 DOZ.



**GL-25112**  
7.25 OZ.  
5" H. X 2" T.  
WATER  
CASE PACK: 2 DOZ.



**GL-25113**  
11 3/4 OZ., HANDMADE  
7 1/4" H. X 2 1/4" T.  
MIAMI LONG DRINK  
CASE PACK: 1 DOZ.



**GL-25114**  
8 OZ., HANDMADE  
7 1/4" H. X 2 1/4" T.  
MIAMI TUMBLER  
CASE PACK: 1 DOZ.



**GL-25115**  
1 3/4 OZ., HANDMADE  
7 1/4" H. X 2 1/4" T.  
MIAMI SHOT  
CASE PACK: 2 DOZ.



**GL-25116**  
16 OZ.  
7" H. X 2 1/2" T. X 3" B.  
TIN CAN GLASS  
CASE PACK: 1 DOZ.











































**GL-25117**  
9 1/2 OZ.  
4" H. X 3 1/4" T. X 3" B.  
MINT JULEP GLASS  
CASE PACK: 2 DOZ.



**GL-25118**  
11 OZ., 3 3/4" H.  
3 1/4" T. X 1 3/4" B.  
LATTICE OLD FASHION GLASS  
CASE PACK: 6 EACH



# GLASSWARE

	 <p><b>GL-1103</b> 9 OZ., 6 3/4" H. 4 1/2" DIA., 4 1/2" T., 3" B. CELEBRATE MARTINI CASE PACK: 1 DOZ.</p>	 <p><b>GL-1104</b> 6 OZ., 8 1/8" H., 2 1/8" DIA. 1 7/8" T., 2 1/2" B. FLORENTINE FLUTE CASE PACK: 2 DOZ.</p>	 <p><b>BEER PILSNER &amp; BEER GLASSWARE COLLECTION (GLASS)</b></p>	 <p><b>GL-1123</b> 15 OZ., 6 5/8" H., 3 1/4" DIA. 3 1/4" T., 2 1/2" B. BAVARIAN PILSNER CASE PACK: 3 DOZ.</p>	<p><b>EXCELLENCY GLASSWARE COLLECTION (GLASS)</b></p>	 <p><b>GL-1108</b> 12 OZ., 6 1/8" H., 4 3/8" DIA. 4 1/4" T., 3 3/4" B. MARGARITA CASE PACK: 2 DOZ.</p>	 <p><b>GL-1109</b> 14 OZ., 6" H., 4 7/8" DIA. 4 7/8" T., 3 1/4" B. MARGARITA CASE PACK: 1 DOZ.</p>	 <p><b>GL-1116</b> 13.5 OZ., 7" H., 3 3/8" DIA. 2 7/8" T., 2 3/4" B. POCO CASE PACK: 1 DOZ.</p>
<p><b>MARTINIS &amp; CHAMPAGNES GLASSWARE COLLECTION (GLASS)</b></p>	 <p><b>GL-1110</b> 15.25 OZ. 6 1/8" H., 4 7/8" DIA., 4 3/4" T., 3 3/8" B. MARGARITA CASE PACK: 1 DOZ.</p>	 <p><b>GL-1111</b> 16.75 OZ., 6 1/4" H. 5" DIA., 4 3/4" T., 3 3/8" B. MARGARITA CASE PACK: 1 DOZ.</p>	 <p><b>GL-1124</b> 12 OZ., 6" H., 3 1/4" DIA. 3 1/4" T., 2 1/2" B. BAVARIAN PILSNER CASE PACK: 3 DOZ.</p>	 <p><b>GL-1126</b> 13 OZ., 9 3/8" H., 2 7/8" DIA. 2 7/8" T., 2 3/4" B. EMPIRE PILSNER CASE PACK: 6 EACH</p>	 <p><b>GL-2926</b> 6.5 OZ. 5 3/8" H., 3 7/8" DIA. 2 5/8" T., 2 1/2" B. WINE CASE PACK: 3 DOZ.</p>	 <p><b>GL-2928</b> 8.5 OZ. 5 5/8" H., 3 1/8" DIA. 2 7/8" T., 2 3/4" B. WINE CASE PACK: 3 DOZ.</p>	 <p><b>GL-2930</b> 10.5 OZ. 6" H., 3 3/8" DIA. 3 1/8" T., 2 3/4" B. WINE CASE PACK: 3 DOZ.</p>	 <p><b>GL-2932</b> 12 OZ. 6 1/8" H., 3 1/4" DIA. 2 7/8" T., 3" B. ALL-PURPOSE WINE CASE PACK: 3 DOZ.</p>
	 <p><b>GL-1114</b> 16 OZ., 5 3/4" H., 4" DIA. 3 3/4" T., 3 3/8" B. HOFFMAN HOUSE CASE PACK: 2 DOZ.</p>	 <p><b>GL-1117</b> 15 OZ., 8 1/4" H. 3 1/8" x 3 1/8" T., 3" B. FOOTED HURRICANE CASE PACK: 1 DOZ.</p>	 <p><b>GL-1128</b> 16 OZ., 5 7/8" H., 3 1/4" DIA. 3 1/4" T., 2 3/8" B. MIXING GLASS CASE PACK: 2 DOZ.</p>	 <p><b>GL-1129</b> 20 OZ., 6 7/8" H., 3 5/8" DIA. 3 5/8" T., 2 3/8" B. MIXING GLASS CASE PACK: 2 DOZ.</p>	 <p><b>GL-2934</b> 7 OZ. 4 3/8" H., 3 1/4" DIA. 3 1/4" T., 2 3/4" B. FOOTED ROCKS CASE PACK: 3 DOZ.</p>	 <p><b>GL-2935</b> 8 OZ. 5 3/8" H., 2 3/4" DIA. 2 3/4" T., 2 3/4" B. FOOTED HIGH BALL CASE PACK: 3 DOZ.</p>	 <p><b>GL-2936</b> 6.5 OZ. 6 1/4" H., 2 5/8" DIA. 2 1/8" T., 2 5/8" B. WINE CASE PACK: 3 DOZ.</p>	 <p><b>GL-2937</b> 10 OZ., 6" H., 2 7/8" DIA. 2 7/8" T., 2 3/4" B. FOOTED HIGH BALL CASE PACK: 3 DOZ.</p>
<p><b>COUNTRY COLLECTION (GLASS)</b></p>	 <p><b>GL-25200</b> 8 OZ., 4 1/4" H. 2 1/5" T. X 2 1/4" B. COCKTAIL JAR CASE PACK: 1 DOZ.</p>	 <p><b>GL-25201</b> 9 OZ., 3 1/2" H. 1/2" T. X 2 3/4" B. ROCKS JAR CASE PACK: 1 DOZ.</p>	 <p><b>GL-25202</b> 12 OZ., 4 3/4" H. 2 1/2" T. X 2 1/2" B. ALL-PURSE JAR CASE PACK: 1 DOZ.</p>	 <p><b>GL-25203</b> 12 OZ., 5 1/4" H. 2 1/4" T. X 2 1/2" B. HI-BALL JAR CASE PACK: 1 DOZ.</p>	 <p><b>GL-2938</b> 8.5 OZ. 6 3/8" H., 2 3/4" DIA. 2 3/8" T., 2 5/8" B. WINE CASE PACK: 3 DOZ.</p>	 <p><b>GL-2939</b> 9 OZ. 4 1/2" H., 3 3/8" DIA. 2 1/4" T., 2 1/2" B. BRANDY CASE PACK: 2 DOZ.</p>	 <p><b>GL-2942</b> 12 OZ. 7 1/8" H., 2 7/8" DIA. 2 1/2" T., 2 5/8" B. PILSNER CASE PACK: 3 DOZ.</p>	 <p><b>GL-2943</b> 12.5 OZ. 4 3/4" H., 3 5/8" DIA. 2 1/2" T., 2 3/4" B. BRANDY CASE PACK: 2 DOZ.</p>
 <p><b>GL-25204</b> 16 OZ., 5" H. 2 5/8" T. X 2 1/2" B. BEVERAGE JAR CASE PACK: 1 DOZ.</p>	 <p><b>GL-25205</b> 16 OZ., 6 3/4" H. 2 1/4" T. X 2 1/2" B. ICED TEA JAR CASE PACK: 1 DOZ.</p>	 <p><b>GL-25206</b> 16 OZ., 5 1/4" H. 2 1/2" T. X 2 3/4" B. ALL-PURPOSE JAR CASE PACK: 1 DOZ.</p>	 <p><b>GL-25207</b> 16 OZ., 5 1/8" H. 3" T. X 3" B. MASON JAR CASE PACK: 1 DOZ.</p>	 <p><b>GL-25208</b> 1 3/4 OZ., 2 1/2" H. 1 1/8" T. X 1 1/4" B. SHOT JAR CASE PACK: 15 DOZ.</p>	 <p><b>GL-2949</b> 10.5 OZ. 5 1/4" H., 3 1/8" DIA. 2 7/8" T., 2 7/8" B. GOBLET CASE PACK: 3 DOZ.</p>	 <p><b>GL-2951</b> 7.25 OZ. 8 1/4" H., 2 1/2" DIA. 2 1/4" T., 2 3/4" B. FLUTE CHAMPAGNE CASE PACK: 1 DOZ.</p>	 <p><b>GL-2952</b> 14 OZ. 7 3/8" H., 3" DIA. 2 1/2" T., 3" B. WHITE WINE CASE PACK: 1 DOZ.</p>	 <p><b>GL-2953</b> 8.5 OZ., 5 3/8" H., 2 7/8" DIA. 2 5/8" T., 2 1/2" B. WHITE WINE CASE PACK: 3 DOZ.</p>

# GLASSWARE, GLASS POLISHER, & GLASS WASHER

## MASON JAR COLLECTION (GLASS)



**GL-25180**  
22 OZ.  
5 1/2" H. X 2 1/2" T. X 3" B.  
HANDLED MASON JAR  
CASE PACK: 2 DOZ.



**GL-25181**  
16 OZ.  
5 1/8" H. X 3" T. X 3" B.  
MASON JAR  
CASE PACK: 2 DOZ.



**GL-25182**  
15 OZ.  
5" H. X 2 1/2" T. X 3" B.  
SQUARE MASON JAR  
CASE PACK: 1 DOZ.



**GL-3450**  
16 OZ.  
4" D. X 5 1/4" H.  
HANDLED MASON JAR  
CASE PACK: 2 DOZ.

## PERFECTION GLASSWARE COLLECTION (GLASS)



**GL-83030**  
15 OZ., 4 1/2" H.,  
2 5/8" T., 2" B. x 3" M.  
STEMLESS WINE GLASS  
CASE PACK: 1 DOZ.



**GL-83031**  
21 OZ., 5" H.,  
3" T., 2 1/4" B., 3 1/2" M.  
STEMLESS WINE GLASS  
CASE PACK: 1 DOZ.



**GL-83032**  
8 OZ., 3 3/4" H., 2 1/4" T.,  
1 1/2" B., 2 3/4" M.  
STEMLESS WINE GLASS  
CASE PACK: 1 DOZ.



**HOT!**

### COMMERCIAL GLASS POLISHER

- REMOVABLE MICROFIBER TWINE POLISHING HEADS SIMULTANEOUSLY POLISH GLASSWARE INSIDE AND OUT
- MICROFIBER MINIMIZES STRESS ON THE GLASS AND THEN DRIES THE GLASSWARE USING THE WARM BLOWER
- POLISHES UP TO 350 GLASSES PER HOUR TO SAVE ON LABOR AND COST OF BREAKAGE
- SEPARATE PULSE, INFINITY, ON & OFF TOUCH PAD CONTROLS
- BUILT IN HANDLES FOR PORTABILITY
- LIGHTWEIGHT, 38 LBS.
- 110V, 1350 WATTS
- LIMITED 2 YEAR MANUFACTURERS WARRANTY

#### ACCESSORIES

- GPLP-551 CHAMPAGNE FLUTE HEAD
- GPLP-552 EXTRA LONG POLISHING HEADS, SET/6
- GPLP-553 STANDARD POLISHING HEADS, SET/5



#### SAVE ON:

- LABOR COSTS
- PROCESSING TIME
- BREAKAGE
- DRYING TIME!



### SUBMERSIBLE GLASS WASHER

- CLEANS GLASSES FASTER THAN BY HAND AND WITH LESS BREAKAGE
- NO SPECIAL PLUMBING OR ELECTRICAL HOOK UP NEEDED, GFI EQUIPPED
- MADE OF HEAVY DUTY STAINLESS STEEL AND BRONZE BEARINGS
- COMES STANDARD WITH 6" SPINNING BRUSH HEADS, REPLACEMENT HEADS ARE AVAILABLE
- 115 VOLTS, 60 HZ, 1/3 HP
- OVERALL DIMENSIONS: 12" L. X 8" W. X 12" H.
- WEIGHT IS 27 POUNDS
- ONE YEAR LIMITED WARRANTY, EXCLUDING BRUSH HEADS

- GW-500 SUBMERSIBLE GLASS WASHER
- PT-500 SET OF 5 BRUSH HEADS

# FILL'N CHILL PARTY TABLE - POLYETHYLENE TABLETOP

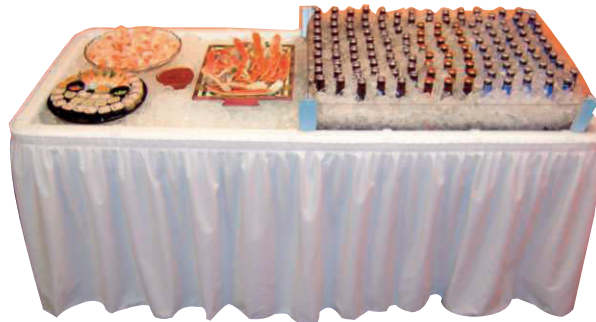

THIS LIGHTWEIGHT AND DURABLE RESIN TABLE HAS COLLAPSIBLE LEGS, STACKABLE, PORTABLE, TAPERED BOTTOM AND CONVENIENT DRAIN HOLE, DUAL STAGE DRAIN AND OPTIONAL SHUT-OFF VALVE, POWDER COATED LEGS. JUST FILL TABLE WITH 75-100 LBS OF ICE AND SIMPLY ADD YOUR FOOD AND BEVERAGES. TABLE SKIRTING COLORS AVAILABLE IN WHITE, BLACK, BURGUNDY, HUNTER GREEN, OR BLUE.

- TAB-75100 73" x 31" x 3.5" DEEP, FILL'N CHILL PARTY TABLE, WHITE
- TAB-75100B 73" x 31" x 3.5" DEEP, FILL'N CHILL PARTY TABLE, BLACK
- AC-75200 3 1/16" THICK x 8" HIGH EXTENSION FOR FILL'N CHILL PARTY TABLE CLEAR POLYCARBONATE PANELS, EDGES ROUNDED FOR SMOOTH FINISH, CENTER DIVIDED INCLUDED, CLEAR WITH WHITE CORNERS AND CENTER "TS"
- AC-75200B 3 1/16" THICK x 8" HIGH EXTENSION FOR FILL'N CHILL PARTY TABLE CLEAR POLYCARBONATE PANELS, EDGES ROUNDED FOR SMOOTH FINISH, CENTER DIVIDED INCLUDED, CLEAR WITH BLACK CORNERS AND CENTER "TS"
- AC-75210 CHILLIN' KWIK COVER FOR FILL'N CHILL PARTY TABLE
- AC-75220 CANVAS COVER FOR FILL'N CHILL PARTY TABLE
- PT-75110 REPLACEMENT DRAIN ASSEMBLY FOR FILL'N CHILL PARTY TABLE
- PT-75130 SHUT OFF VALVE FOR FILL'N CHILL PARTY TABLE
- TRS-75025 BAG OF 25 SKIRTING CLIPS FOR FILL'N CHILL PARTY TABLE, WHITE
- TRS-75025B BAG OF 25 SKIRTING CLIPS FOR FILL'N CHILL PARTY TABLE, BLACK
- TRS-75050 BAG OF 50 SKIRTING CLIPS FOR FILL'N CHILL PARTY TABLE, WHITE
- TRS-75050B BAG OF 50 SKIRTING CLIPS FOR FILL'N CHILL PARTY TABLE, BLACK
- TRS-75100 BAG OF 100 SKIRTING CLIPS FOR FILL'N CHILL PARTY TABLE, WHITE
- TRS-75100B BAG OF 100 SKIRTING CLIPS FOR FILL'N CHILL PARTY TABLE, BLACK
- TSP-75001 SKIRTING, 100% POLYESTER, MINI ACCORDION, 29.5 H.
- TSP-75002 SKIRTING, 100% POLYESTER, SHIRRED, 29.5 H.
- TSP-75101 PREMIER SKIRTING, 100% POLYESTER, MINI ACCORDION, 29.5 H.
- TSP-75102 PREMIER SKIRTING, 100% POLYESTER, SHIRRED, 29.5 H.

### LITTLE FILL'N CHILL PARTY TABLE (POLYETHYLENE TABLETOP)

A SMALLER VERSION OF OUR TRADITIONAL ICED PARTY TABLE, THIS LITTLE FILL'N CHILL TABLE HOLDS 35-50 POUNDS OF ICE, KEEPING ALL OF YOUR FOOD AND PARTY ACCESSORIES NICE AND COLD. PERFECT FOR SMALLER SPACES, THE TABLE HAS COLLAPSIBLE LEGS AND WILL FIT IN THE TRUNKS OF MOST CARS, MAKING THIS A PERFECT OPTION FOR YOUR GAME DAY CELEBRATIONS. OPTIONAL ACCESSORIES ARE AVAILABLE FOR THE TABLE, TOO, INCLUDING FULL AND 2/3 DEPTH EXTENDERS AND INSERTS TO GIVE YOU A FLAT SPACE.

- TABLE SIZE IS 48" L. X 24" W. X 3 1/2" DEEP
- RUGGED LIGHTWEIGHT CONSTRUCTION
- DURABLE, EASY TO CLEAN, ONE PIECE, FDA APPROVED, POLY-ETHYLENE TABLETOP
- TAPERED BOTTOM WITH CENTRALLY LOCATED DRAIN, DUAL -STAGE DRAIN AND OPTIONAL SHUT-OFF VALVE
- STURDY, POWDER COATED, COLLAPSIBLE STEEL LEGS
- STACKABLE DESIGN FOR CONVENIENT STORAGE
- EASILY TRANSPORTABLE

- TAB-74100 48" L. X 24" W. X 3.5", FILL'N CHILL PARTY TABLE, WHITE
- TAB-74100B 48" L. X 24" W. X 3.5", FILL'N CHILL PARTY TABLE, BLACK
- AC-74200 FULL SIZE DEPTH EXTENSION KIT, WHITE
- AC-74200B FULL SIZE DEPTH EXTENSION KIT, BLACK
- AC-74300 2/3 DEPTH EXTENSION KIT, WHITE
- AC-74300B 2/3 DEPTH EXTENSION KIT, BLACK
- AC-74400 INSERT, WHITE
- AC-74400B INSERT, BLACK
- TSP-74001 MINI ACCORDION, POLYESTER KNIT, 12" x 29.5" H.
- TSP-74002 SHIRRED POLYESTER KNIT, 12" x 29.5" H.
- TSP-74101 MINI ACCORDION PREMIERE POLYESTER, 12" x 29.5" H.
- TSP-74102 SHIRRED PREMIERE POLYESTER, 12" x 29.5" H.



### ICE TRAYS

THIS DISPLAY IS UNIQUE AND MODERN AND WILL COMPLEMENT ANY DECOR AND ENHANCE ANY FOOD PRESENTATION. INCLUDES STAND, PETG ICE PAN, DRAINAGE HOSE, AND BASIC LED LIGHTING. SHIPS BY TRUCK ONLY. CALIFORNIA PROP 65. BPA FREE.

- TR-986 28.5" W. x 20.5" D. x 5.5" H.
- TR-987 48" W. x 24" D. x 5.5" H.

# PORTABLE BARS, DISH CADDIES, & COOLER CART



### PORTABLE BAR

THIS PORTABLE BAR HAS A POLYPROPYLENE EXTERIOR, ROUNDED CORNERS, AND HEAVY DUTY CASTERS. UNIT COMES FULLY ASSEMBLED. PRODUCT INCLUDES SPEED RAIL. AVAILABLE IN BLACK (110), DARK BROWN (131), GRANITE GRAY (191), GRANITE SAND (194), GRANITE SAND (194), SLATE BLUE (401), BLACK BASE WITH COAL COUNTER (670), GRANITE GRAY WITH SLATE GRAY (671), GRANITE SAND BASE WITH COCOA COUNTER (672). SHIPS BY TRUCKS ONLY.  
BAR-45630 54" L. x 25 7/8" W. x 46 1/8" HT.



### INDOOR/OUTDOOR BLACK CURVED PORTABLE BARS

THIS CURVED BAR FEATURES ALL ALUMINUM COMPOSITE MATERIAL CONSTRUCTION WITH MATCHING TOE KICK. HEAVY DUTY CASTERS ENSURES STABILITY. OPEN STORAGE FOR QUICK AND EASY ACCESS. BUILT IN POLYFORM SPEED RAILS. POLYFORM WORK & SERVICE COUNTERS. INCLUDES FULL SIZE PAN, COVER AND FALSE BOTTOM.  
SHIPS BY TRUCKS ONLY.

EQP-75683  
EQP-75685

5' CURVED PORTABLE BAR  
8' CURVED PORTABLE BAR

60" X 33 1/2" X 44"  
94" X 45 1/2" X 44"



### DESIGNER SERIES PORTABLE BAR

DESIGNER SERIES PORTABLE BAR, CARMEL, BLACK BASE, COAL COUNTERTOP AND DARK BURLWOOD PANELS.  
SHIPS BY TRUCKS ONLY.  
BAR-480 72 3/4" L. x 26" W. x 48" H.

### STANDARD SERIES PORTABLE BAR

- A PORTABLE BEVERAGE BAR IDEAL FOR BANQUETS AND LARGE EVENTS
- WATERPROOF PLASTIC WON'T CRACK, DENT, BUBBLE, RUST, OR CHIP
- FEATURES A 7-BOTTLE SPEED RAIL AND WASTE-WATER BIN
- 80-POUND CAPACITY ICE SINK WITH COVER FOR EASY ACCESS
- DESIGNED WITH 6" SWIVEL CASTERS WITH TWO BRAKES
- INCLUDES A VINYL COVER FOR HYGIENIC STORAGE
- EASY TO TAKE APART, CLEAN, AND SET UP
- COLOR: GRANITE GREY, GRANITE SAND, & BLACK
- SHIPS BY TRUCKS ONLY.



BAR-481 72 3/4" L. x 26" W. x 48" H.



### INDOOR/OUTDOOR BLACK PORTABLE BAR

THIS 5 FOOT LONG STRAIGHT BAR IS PERFECT FOR INDOOR OR OUTDOOR USE. MADE OF ALL ALUMINUM COMPOSITE MATERIAL WITH MATCHING TOE KICK. HEAVY DUTY CASTERS MEANS THE BAR WON'T ROLL AWAY, AND OPEN STORAGE MEANS QUICK AND EASY ACCESS FOR THE BARTENDER, RESULTING IN FASTER SERVICE FOR YOUR GUESTS. THE BAR INCLUDES BUILT IN POLYFORM SPEED RAILS AS WELL AS POLYFORM WORK AND SERVICE COUNTER. 1" BLACK BUMPER ON ALL SIDES. BAR ALSO INCLUDES FULL SIZE PAN, COVER AND FALSE BOTTOM. SHIPS BY TRUCKS ONLY.

EQP-98744 5' STRAIGHT BAR x 61" W. x 32.75" DEPTH

### STAND SERIES PORTABLE BAR

- A PORTABLE, MID-SIZE BEVERAGE BAR THAT FITS STANDARD ELEVATORS
- WATERPROOF PLASTIC WON'T CRACK, DENT, BUBBLE, RUST, OR CHIP
- FEATURES A 7-BOTTLE SPEED RAIL AND WASTE-WATER BIN
- 80-POUND CAPACITY ICE SINK WITH COVER FOR EASY ACCESS
- DESIGNED WITH 6" SWIVEL CASTERS WITH TWO BRAKES
- INCLUDES A VINYL COVER FOR HYGIENIC STORAGE
- EASY TO TAKE APART, CLEAN, AND SET UP
- GRANITE GRAY (191) COLOR ONLY
- SHIPS BY TRUCKS ONLY



BAR-483 67 1/2" L. x 28 1/2" W. x 47 1/2" H.

### DISH CADDY

CADDY HAS ROUNDED CORNERS TO PREVENT DAMAGE TO WALLS AND DOORS. DIVIDER POST IS ADJUSTABLE, OFFERING MAXIMUM FLEXIBILITY TO ACCOMMODATE TRAYS AND PLATES IN A VARIETY OF SIZES. EACH COLUMN HOLDS 45-60 PLATES, RANGING FROM 4.5" DIA. TO 13" DIA. ACTUAL CAPACITY WILL VARY BASED ON PLATE SIZE AND CONFIGURATION.



DC-250  
31" L. x 28" W. x 26" H.

### ADJUSTABLE DISH CADDY (POLYETHYLENE)

THIS DISH CADDY CAN HOLD APPROXIMATELY 45-60 PLATES PER COLUMN. DIVIDERS ADJUST FROM 4 5/8" TO 13" AND ALL SIZES IN BETWEEN; USE 6 DIVIDERS FOR SMALLER PLATES, 4 5/8" TO 9", 4 DIVIDERS FOR LARGER PLATES, 9" TO 13" CASTERS: 5", 2 SWIVEL WITH BRAKES AND TWO 10" BIG WHEELS EASILY HANDLE LONG DISTANCE TRANSPORTING DOWN HALLWAYS OR BETWEEN VENUES, MOLDED-IN HANDLES ON BOTH ENDS MAKE FOR EASY TRANSPORTING. VINYL COVER INCLUDED.  
AVAILABLE COLORS: BLACK (110), DARK BROWN (131), SLATE BLUE (401), SPECKLED GRAY (480), PLEASE SPECIFY COLOR.

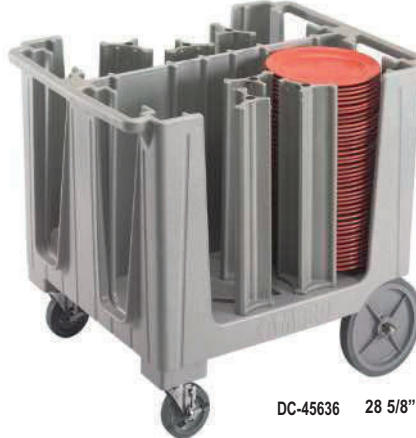

DC-45636 28 5/8" W. x 37 3/4" L. x 31 7/8" H.

### COOLER CART

THIS 65 QUART COOLER CART IS IDEAL FOR CATERING, PARTIES, AND MOST OUTDOOR EVENTS. THE HINGED LID OPENS ON BOTH SIDES FOR EASY ACCESS. IT FEATURES A REMOVABLE STAINLESS STEEL BOTTLE OPENER, CAP CATCHER, DRAIN PLUG, AND 3" CASTER THAT CAN LOCK TO HOLD COOLER IN PLACE.



EQP-8880  
65 QT.  
31 1/8" L. X 15 3/8" W. X 32 2/3" H.

# CARTS, COOLERS, & CADDIES



### INSULATED ICE CADDY WITH SLIDING COVER (POLYETHYLENE BODY, POLYURETHANE INSULATION)

THIS INSULATED ICE CADDY HAS A SLIDING COVER, SO THERE'S NOTHING TO LOSE. AN INSIDE SHELF SEPARATES ICE FROM WATER, INCREASING STORAGE TIME AND PREVENTING THE ICE FROM TURNING INTO ONE HUGE BLOCK. THE RECESSED FRONT END HANDLE MAKE PULLING OR PUSHING EASY. CAN BE USED INDOORS OR OUT. PLUS - NO ASSEMBLY REQUIRED! JUST OIL THE WHEEL BEARINGS AND PUT IN USE. NSF LISTED.

IC-300 23" L. x 31.5" W. x 29.25" H.



### PORTABLE ICE CADDY

THIS UNIT FEATURES A UNIQUE SLIDING LID THAT HELPS REDUCE THE RISK OF CROSS CONTAMINATION. IT SLIDES BACK AND UNDER FOR QUICK AND EASY ACCESS AND IT SLIDES SHUT FOR SAFE AND SANITARY STORAGE.

THE RECESSED WELL AND DRAIN SHELF KEEP ICE OUT OF WATER, EXTENDING HOLDING TIMES. THE RECESSED HANDLE ON THE FRONT END MAKES IT VERY EASY TO MOVE OR LIFT.

- EASY TO CLEAN
- HAS 2 SWIVEL AND 2 LOCKING CASTERS
- NO ASSEMBLY REQUIRED
- AVAILABLE COLORS: BLACK (110), SLATE BLUE (401), DARK BROWN (131), COFFEE BEIGE (157), GRANITE GRAY (191). SPECIFY COLOR WHEN ORDERING.

BAR-45629 22 1/2" W. x 30 1/4" DEEP x 28 3/4" HT.



### WORK STATION

PAPER TOWEL DISPENSER INCLUDED. DURABLE POLYETHYLENE WILL NOT CRACK, DENT, BUBBLE, CHIP OR BREAK. EASY TO CLEAN. 6" CASTERS, 2 FIXED, 2 SWIVEL WITH BRAKE. COLORS: GRANITE GREY, GRANITE GREEN, NAVY BLUE, HOT RED, GREEN.

WS-KWS40  
40 9/16" x 32 1/2" x 45 1/2"



### HAND SINK CART W/ TWO COMPARTMENT STAINLESS SINK

THIS HAND SINK CART HAS A TWO COMPARTMENT STAINLESS STEEL SINK AND RUNS COLD AND HOT WATER UP TO 140 DEGREES FAHRENHEIT. TWO 5 GALLON FRESH WATER TANKS AND TWO 7 1/2" GALLON REFUSE TANKS PROVIDE APPROXIMATELY 70 HAND WASHINGS. THE TANKS ARE EASY TO INSERT OR REMOVE FOR EMPTYING AND REFILLING. THE HOT WATER HEATER HAS A 2 1/2 GALLON CAPACITY AND HEATS WATER IN 10 MINUTES. COLORS: GRANITE GRAY (191), GRANITE GREEN (192), NAVY BLUE (186), HOT RED (158), GREEN (519), BLACK BASE WITH GRANITE GRAY TOP & DOORS (426). PLEASE SPECIFY COLOR WHEN ORDERING.

- MADE OF TOUGH, DURABLE POLYETHYLENE
- PAPER TOWEL HOLDER AND SOAP DISPENSER ARE INCLUDED
- 4, 6" SWIVEL CASTERS; 2 SWIVEL, 2 FIXED, 2 WITH BRAKE
- WATER HEATER AND WATER PUMP DRAW A MAXIMUM OF 11.25 AMPS AND 0.7 AMPS, RESPECTIVELY. HAND SINK CART ELECTRICAL SYSTEM RUNS ON AN AVERAGE 10 AMPS
- HAND SINK CART IS DESIGNED FOR HAND WASHING, IT CONTAINS NO FILTER FOR PURIFYING WATER FOR DRINKING

EQP-402110 110 VOLTAGE, 40 9/16" L. X 32 1/2" W. X 45 1/2" H.



### TRAY & SILVER CART

TAILOR MADE FOR TRAY SERVICE, THIS PRODUCT ORGANIZES TRAYS AND ACCESSORIES FOR SELF SERVICE IN ONE COMPACT UNIT. CLEAR PANS ARE INCLUDED FOR EIGHT BUILT IN AND HEAVY DUTY SELF SERVICE TOP COMPARTMENTS THAT HOLD FLATWARE, NAPKINS AND CONDIMENTS. A VINYL COVER IS INCLUDED FOR ADDED PROTECTION.

6" SWIVEL CASTERS. AVAILABLE COLORS: BLACK(110), SLATE BLUE(401), COFFEE BEIGE(157), DARK BROWN(131), GRANITE GRAY(191), GRANITE GREEN(192). SPECIFY COLOR WHEN ORDERING. MAXIMUM TRAY SIZE: 14" x 18", 180-200 IN TWO STACK

CART-1503  
32 3/8" L. x 21 1/4" W. x 45 1/2" H.



### 3 TIER TROLLEY (STAINLESS)

VERSATILE, STRONG AND DURABLE.

CART-30 30" x 16" x 32"



### 3 SHELF BUSSING CART

HEIGHT BETWEEN SHELVES IS 13". THE CART HAS A CHROME TUBULAR STEEL FRAME AND 4" CASTERS. MADE IN U.S.A.

EQP-97186 26 5/8" x 15 3/4" X 34 1/2"



### BUS BOXES (POLYPROPYLENE)

HEAVY DUTY BUS BOXES HAVE CONTOURED LIPS FOR EASY HANDLING.

20 1/4" x 15 1/2" x 5"  
BB-37023B BLACK  
BB-37023G GRAY  
BB-37023W WHITE



### 3 TIER MULTI PURPOSE CARTS

EACH SHELF HAS A TEXTURED FINISH TO MINIMIZE PRODUCT SHIFTING DURING TRANSPORT, AND THE 4" SWIVEL NON-MARKING CASTERS MAKE FOR EASY MANEUVERABILITY. THE SHELVES AND HANDLES ARE MADE OF POLYPROPYLENE, SO THE COMPLETE UNIT IS DURABLE, LIGHTWEIGHT AND EASY TO CLEAN. THERE'S AN 11 3/4" SPACE BETWEEN EACH SHELF, WHICH MEANS YOU CAN MAKE THE MOST OUT OF EVERY TRIP. SHIPPED KNOCKED DOWN AND EASY TO ASSEMBLE, SO YOU CAN GET STARTED RIGHT AWAY.

CART-97004	33" X 16 13/16" X 37"	BLUE/GREY
CART-97005	40 1/4" X 19 7/8" X 37"	BLUE/GREY
CART-97006	33" X 16 13/16" X 37"	BLACK/GREY
CART-97007	40 1/4" X 19 7/8" X 37"	BLACK/GREY



### 3 SHELF KNOCK DOWN CARTS

- CHROME-PLATED TUBULAR FRAME
- 20 GAUGE STAINLESS STEEL SHELVES
- 4" CASTERS
- HEIGHT BETWEEN SHELVES: 8 1/2"
- MADE IN USA

EQP-97105 HOLDS 400 LBS 28 1/16" x 36 1/8" x 16 1/6"  
EQP-97106 HOLDS 500 LBS 40 1/2" x 21" x 36 1/2"



### COMPARTMENTED BUS BOXES (POLYPROPYLENE)

THESE STACKABLE BUS BOXES CONSERVE SPACE AND ARE SCUFF, GREASE, AND STAIN RESISTANT. DISHWASHER SAFE. COLOR: GRAY (23)

AC-1071 21 1/4" x 11 1/2" x 3 3/4" HT., SILVERWARE TRAY  
AC-386G 22" x 17" x 5" HT.

(4) COMPARTMENTS CUTLERY BIN, BPA FREE



### WHITE TOTE BOXES

HIGH DENSITY POLYETHYLENE FREEZER SAFE WHITE TOTE BOX.

BB-37024 15.25" x 20.5" x 5" BOX  
BB-37025 15.25" x 20.5" x 7" BOX  
BB-37026 COVER FOR BB-37024 OR BB-37025



### BUS BOXES (POLYPROPYLENE)

HEAVY DUTY BUS BOXES HAVE CONTOURED LIPS FOR EASY HANDLING. GRAY COLOR. BB-37723 21.5" L. x 15" W. x 7" H.



### BUS BOXES (POLYPROPYLENE)

21 1/4" x 15 3/8" x 4 7/8", HEAVYWEIGHT.

BB-400W PERFORATED WHITE  
BB-400G PERFORATED GRAY

### BUS BOXES (POLYPROPYLENE)

2 COMPARTMENTS, ECONOMICAL STORAGE FOR HEAVY LOADS, ROUNDED CORNERS FOR EASY CLEANING. HEAVYWEIGHT.



BB-450G GRAY 21" L. x 16 3/4" W. x 6.5" H.  
BB-450B BLACK 21" L. x 16 3/4" W. x 6.5" H.

# FOOD BARS & INSULATED BEVERAGE SERVERS



### MOBILE BREATH GUARD

ADJUSTABLE HEIGHT 14.25" TO 25.25" AND ANGLE WORKS WITH MOST COUNTER TOP SERVING PIECES, CHAFERS, AND WARMER, RUGGED STEEL BASS WITH POWDER COATING, CURVED ACRYLIC GLASS WHICH IS DURABLE AND CONTEMPORARY, 3 STANDARD SIZES 3', 4' AND 5' SIZED FOR STANDARD BANQUET TABLES, WORKS AS SINGLE OR BACK TO BACK. SHIPPED KNOCKED DOWN, EASY TO ASSEMBLE. MADE IN USA.

- EQP-98720 36" L. MOBILE BREATH GUARD
- EQP-98721 48" L. MOBILE BREATH GUARD
- EQP-98722 60" L. MOBILE BREATH GUARD



### PORTABLE BUFFET SNEEZEGUARDS

PORTABLE DECORATIVE UNIT WITH CLEAR ACRYLIC SNEEZE GUARD. MADE BLACK IRON FRAME WITH SCRATCH RESISTANT ACRYLIC SNEEZEGUARD. ELEGANTLY DESIGNED SNEEZEGUARD PERFECT FOR TRANSPORTING FOR CATERING.

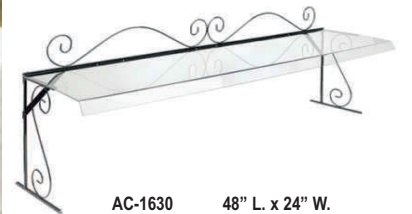

- AC-1630 48" L. x 24" W.
- AC-1631 72" L. x 24" W.



### TABLE TOP BUFFET FOOD BAR (POLYETHYLENE)

THIS BASIC TABLE TOP BAR MODEL MERCHANDISES ANY MENU OFFERINGS. SEAMLESS CONSTRUCTION ELIMINATES THE POSSIBILITY OF LEAKAGE FROM MELTED ICE. THIS TABLE TOP BUFFET BAR IS PORTABLE, DURABLE, LIGHTWEIGHT AND EASY TO CLEAN. INCLUDED SNEEZE GUARD PROTECTS FOOD FROM OUTSIDE INFLUENCES. SHIPS BY TRUCKS ONLY.

- 5 FULL SIZE PAN CAPACITY
- OVERALL EXTERIOR: 73 7/8" L X 24 1/8" W X 24 1/2" H;
- WELL INTERIOR: 62 7/8" L X 20 1/8" W X 5"
- AVAILABLE COLORS: BLACK, NAVY BLUE, HOT RED, GREEN

FC-7500



### POLYETHYLENE TABLETOP SERVERS

DUAL SIDED SERVICE AREA WITH DOUBLE-SIDED ACRYLIC SNEEZE GUARD. ALSO FEATURES THREADED DRAIN PLUG UNDERNEATH ICE PAN FOR EASY WATER REMOVAL. COLORS: BLACK(03), BROWN(01), FOREST GREEN(08), AND RED(05), SPECIFY COLOR WHEN ORDERING.

- FC-7600 4 FT. 3 PAN SIZE 23.68" W. x 25.25" H.
- FC-7601 6 FT. 4 PAN SIZE 23.68" W. x 25.25" H., BLACK ONLY.
- \*NOTE #7601 SHIPPED BY TRUCK ONLY.



### BUFFET BAR AND SNEEZE GUARD (POLYETHYLENE)

THIS HEAVY DUTY CONSTRUCTION BUFFET BAR HAS A LIP FOR EASY LIFTING AND DROPPING INTO THE CUT-OUT UNIT. FEATURES DRAIN PLUG AT THE END OF EACH UNIT AND TEXTURED FINISH. 15" WIDE. SNEEZE GUARD FITS OVER BUFFET BAR. BRONZE FINISH WITH CLEAR ACRYLIC SIDES. 46" HT. COLORS: BLACK (03), AND BROWN (01). FOREST GREEN (08) FOR 4 PT ONLY. SPECIFY COLOR WHEN ORDERING.

- AC-9710 4 FT. SNEEZE GUARD, BLACK ONLY
- AC-9712 6 FT. SNEEZE GUARD, BLACK ONLY
- FC-7670 4 FT. BUFFET BAR, 24.87" W. x 6.62" H.
- FC-7671 6 FT. BUFFET BAR, 24.87" W. x 6.62" H.



### SNEEZE GUARD



### ULTRA CAMTAINERS® (POLYETHYLENE)

COLORS: NAVY BLUE(186), SLATE BLUE(401), COFFEE BEIGE(157), DARK BROWN(131), BRICK RED(402), BLACK(110), GRANITE GRAY(191), GRANITE SAND(194). PLEASE SPECIFY COLOR WHEN ORDERING.

- UR-254 3 GAL. 48 CUP 11 3/4" x 16 3/4" x 19 3/4" H.
- UR-255 5.5 GAL. 88 CUP 11 3/4" x 16 3/4" x 26 5/8" H.
- UR-256 10 GAL. 160 CUP 16 1/4" x 20 1/2" x 25 3/4" H.

### INSULATED SOUP & CHILI SERVERS (POLYETHYLENE)

COLOR OPTIONS: BROWN (01), AND BLACK (03). PLEASE SPECIFY COLOR WHEN ORDERING.

- FC-350 3.5 GAL. 16.5" x 8.87" x 18"
- FC-500 5 GAL. 16.25" x 8.53" x 21.2"



### CAMTAINERS BEVERAGE/SOUP SERVER

COLORS: NAVY BLUE(186), SLATE BLUE(401), COFFEE BEIGE(157), DARK BROWN(131), BRICK RED(402), GREEN(519), BLACK(110), HOT RED(158). PLEASE SPECIFY COLOR WHEN ORDERING.

- UR-257 1.5 GAL. 18 CUP 10 3/8" x 11 3/4" x 17 1/4" BEVERAGE
- UR-258 2.5 GAL. 48 CUP 9" x 16 5/8" x 18 1/4" H. BEVERAGE
- UR-259 4 3/4 GAL. 88 CUP 9" x 16 5/8" x 24 1/4" H. BEVERAGE
- UR-260 10.5 GAL. 160 CUP 16 1/4" x 20 11/16" x 24 3/4" H. BEVERAGE
- UR-261 3.5 GAL. 52 CUP 9" x 16 5/8" x 18 3/8" H. SOUP, NO SPIGOT



### CATERAIDE™ INSULATED BEVERAGE SERVERS

INSULATED BEVERAGE SERVER WITH XT LID DESIGN AND IMPROVED SEAL TO ELIMINATE LEAKS DURING TRANSPORT. SURE-LATCH WIDE DESIGN. POP UP VENT. STACKS WITH MOST BEVERAGE SERVERS TO SAVE SPACE, PLEASE SPECIFY COLOR WHEN ORDERING: BLACK (03), BROWN (01), FOREST GREEN (08) SLATE BLUE (59).

- UR-4250 2.5 GAL. 17" x 10.5" x 18.5" H.
- UR-4500 5 GAL. 17.4" x 10.5" x 25.75" H.
- UR-41000 10 GAL. 20.63" x 16.38" x 26.75" H.



### COLDMASTER® DISPENSER (ACRYLIC)

FAUCET STYLE DISPENSER OFFERS BETTER CONTROL FOR DISPENSING LIQUIDS. NON-TOXIC REFRIGERANT GEL HOLDS TEMPERATURE LONGER THAN ANY OTHER SIMILAR PRODUCT. COLDMASTER® SYSTEM ELIMINATES THE INCONVENIENCE AND MESS OF ICE, AS WELL AS REDUCES THE POTENTIAL OF BACTERIA. TEMPERATURE RANGE: 32.00°F - 180.00°F. BPA FREE.

- UR-1017 0.5 QT., 9.88" SQ. (WITH LID) X 12.85" H., BLACK

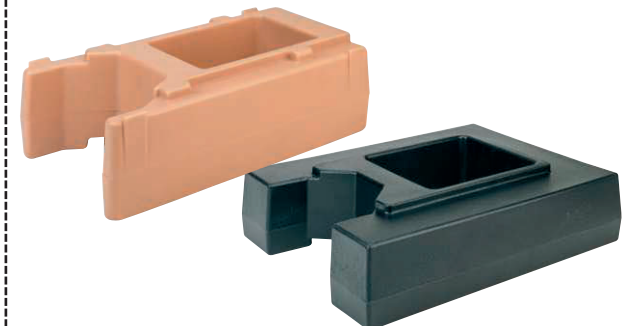

### CAMTAINER RISERS

SPECIFY COLOR WHEN ORDERING: NAVY BLUE (186), SLATE BLUE (401), COFFEE BEIGE (157), DARK BROWN (131), BRICK RED (402), GREEN (519), BLACK (110), HOT RED (158), GRANITE GRAY (191), GRANITE GREEN (192).

- AC-1014 16 1/4" x 9 1/8" x 4 9/16" FITS UR-258, UR-259, UR-254, UR-355
- AC-1015 19 1/2" x 15 3/8" x 4 1/2" FITS UR-260, UR-256

# INSULATED CARRIERS & SIGNS



### INSULATED FRONT LOADING SHEET PAN CARRIER

THIS CAMBRO UNIT IS A FAVORITE WITH THE CATERERS AND RENTAL STORES. IT IS A COMPACT SIZE AND HAS THE ABILITY TO HOLD HOT OR COLD FOODS FOR 4+ HOURS WITHOUT ELECTRICITY. IT HOLDS UP TO SIX FULL SIZE SHEET PANS OR TRAYS THAT ARE 18" X 26" WITH A 2 1/8" SEPARATION BETWEEN EACH TRAY. PLEASE SPECIFY YOUR COLOR WHEN ORDERING. AVAILABLE COLORS: BLACK (110), DARK BROWN(131), COFFEE BEIGE(157), NAVY BLUE (186), SLATE BLUE (401), CHARCOAL GRAY (615).

FC-1860 29 1/4" W. x 22 1/2" H. x 21 1/2" D.

### INSULATED END LOADER / SHEET PAN & TRAY CARRIER (SHELL=POLYETHYLENE; INSULATION=POLYURETHANE)

THIS INSULATED SHEET PAN AND TRAY CARRIER HAS BEEN DESIGNED TO MEET TOUGH NSF STANDARDS AND IS MADE OF RUGGED, STAIN - AND SCRATCH - RESISTANT POLYETHYLENE. IT IS ALSO FILLED WITH EXTRA THICK POLYURETHANE FOAM INSULATION FOR MAXIMUM TEMPERATURE RETENTION.



- HEAT RESISTANT TO 200 DEGREES FAHRENHEIT; MADE IN U.S.A. NSF LISTED. AVAILABLE COLORS: BLACK, BROWN.

- EXTERIOR: 28.75" L. X 21" W. X 22.12" H.  
- INTERIOR: 26.12" L. X 18.37" W. X 13.12" H.  
- INDIVIDUAL TRACKS ACCOMMODATE SEVEN 18" X 26" TRAYS OR SHEET PANS

FC-1826



### CATER COOLER™

LET THE UNIT FREEZE OVER NIGHT. THE NEXT DAY, IT WILL KEEP FOODS FRESH AND COLD FOR UP TO 8 HOURS. FITS FC-300 AND FC-600 END LOADERS.

FC-660 20 3/4" L. x 12 3/4" W. x 2 1/2" H.

### INSULATED END LOADERS (SHELL: POLYETHYLENE, INSULATION: POLYURETHANE)

HELPS KEEP FOODS AT THEIR OPTIMAL TEMPERATURES UNTIL THEY'RE READY TO BE SERVED. STACKABLE AND EASY TO TRANSPORT. COLOR: BLACK (03), BROWN (01), SLATE BLUE (59), AND FOREST GREEN (08). PANS NOT INCLUDED. PLEASE SPECIFY COLOR WHEN ORDERING. MADE IN U.S.A. NSF LISTED.

FC-300 INSULATED END LOADER 25.25" H. x 24.25" L. x 17" W.  
FC-600 INSULATED DOUBLE END LOADER 50" H. x 24.25" L. x 17" W.  
PT-300X BLACK NYLON LATCHES FOR FC-300



### INSULATED FRONT LOADED CARRIER

TRANSPORT HOT OR COLD FOOD FOR 4+ HOURS WITHOUT ELECTRICITY. NSF LISTED. AVAILABLE COLORS: SLATE BLUE (401), GRANITE GREY (191), GRANITE GREEN (192), GRANITE SAND (194), COFFEE BEIGE (157), NAVY BLUE (186), BLACK (110), DARK BROWN(131). COLD BLUE (159) FOR FC-401

FC-400 18" x 25" x 24.875"

HOLDS 4 FULL SIZE 4" DEEP FOOD PANS

FC-401 17" W. X 25 3/4" D. X 22 3/8" H.

HOLDS 4 FULL SIZE 2.5" DEEP OR 8 HALF SIZE 2.5" DEEP OR 12 THIRD SIZE 2.5" DEEP FOOD PANS

### WARMER

USE ONE OR TWO TO SUSTAIN HOT FOOD TEMPERATURE AT HIGHER AND SAFER LEVELS WITHIN INSULATED FOOD PAN CARRIERS AND CARTS. PROVEN TO KEEP HOT FOODS ABOVE 140 DEGREES(F) FOR ALMOST TWO HOURS LONGER!

FC-4501 13 1/4" x 10 7/8" x 1 9/16"



### CAMCHILLER

FREEZE FLAT FOR 8 HOURS, THEN PRE-CHILL CABINET FOR ABOUT 20 MINUTES. SLIDE COLD FOOD UNDERNEATH THE CHILLER TO MAXIMIZE TEMPERATURE RETENTION. COLOR: BLUE.

FC-4506 20 13/16" x 12 7/8" x 1 1/2"  
FC-4507 10 3/8" x 12 3/4" x 1 1/2"  
FC-4508 14" x 8" x 1 1/2"

- EASY TO USE  
- NSF CERTIFIED  
- DISHWASHER SAFE  
- STACKABLE  
- STORE SAFE



### INSULATED COMBO CARRIER

36 QUART INSULATED COMBO CARRIER THAT CAN DO IT ALL. IT IS COMPACT, BUT YET CAN HOLD A COMBINATION OF TRAYS, HALF SIZE SHEET PANS, AND FOOD PANS. AVAILABLE COLOR: BLACK, DARK BROWN, HOT RED, NAVY BLUE, SLATE BLUE, CHARCOAL GRAY.

FC-1310



- INSULATION KEEPS COLD FOOD BELOW 41° F AND HOT FOOD ABOVE 140° F FOR 4+ HOURS  
- EXTERIOR: 17" W X 25 3/4" D X 22 3/8" H  
- INTERIOR: 13 1/4" W X 21" D X 14" H  
- LIGHTWEIGHT AND STACKABLE  
- FULLY REMOVABLE, GASKETLESS DOOR FOR EASY CLEANING  
- LABELING AREA ON DOOR FOR ADHERING ID OR ROUTING LABELS  
- TRAY AND SHEET PAN CAPACITY: 8 EACH 13" X 18" AT 1 1/2" SPACING

### INSULATED FRONT LOADING FOOD PANS & SHEET PANS CARRIER

IT IS FULLY INSULATED AND SMALL ENOUGH TO FIT IN A CARTERING VAN. TRANSPORT HOT (ABOVE 140F) OR COLD (BELOW 41F) FOOD SAFELY FOR 4+ HOURS, WITHOUT ELECTRICITY. THE DOOR HAS A BUILT IN SEAL AND IS REMOVABLE FOR EASY CLEANING. THE UNIT IS GASKETLESS TO ELIMINATE REPLACEMENT PARTS. HOLDS 4 FULL SIZE 2 1/2" DEEP OR 8 HALF SIZE 2 1/2" DEEP OR 12 THIRD SIZE 2 1/2" DEEP FOOD PANS. NSF LISTED. AVAILABLE IN 5 COLORS. (BLACK, CHARCOAL GRAY, DARK BROWN, HOT RED, NAVY BLUE). PLEASE SPECIFY COLOR WHEN ORDERING.



FC-410

17" W. X 25 3/4" D. X 22 3/8" H.



### BEVERAGE TENTS

FEATURING BLACK LETTERING. 3" W. X 1" D. X 1.5" H.

AC-70 COFFEE (GOLD)  
AC-71 COFFEE (SILVER)  
AC-72 DECAF (GOLD)  
AC-73 DECAF (SILVER).  
AC-74 HOT WATER (GOLD)  
AC-75 HOT WATER (SILVER)  
AC-78 ICED TEA (GOLD)  
AC-79 ICED TEA (SILVER)

### BLACK WOOD SIGNS

3" W. x 1.75" H. TRIANGULAR WOODEN BLOCKS FEATURE SLEEK SILVER LABELS.

SG-500 HOT TEA  
SG-501 ICED TEA  
SG-502 COFFEE  
SG-503 DECAF  
SG-504 HOT WATER  
SG-505 RESERVED DOUBLE SIDED SIGN  
SG-506 NO SMOKING DOUBLE SIDED SIGN



### BLACK CHALKBOARD BEVERAGE SIGNS

THEY COME PRE-PRINTED OR BLACK FOR YOU TO WRITE-ON AS NEEDED. SOLD IN CASE PACKS OF 1 DOZEN. 3" W. X 1" D. X 2" H.



ACT-200 WRITE-ON  
ACT-201 COFFEE  
ACT-202 DECAF  
ACT-203 HOT WATER  
ACT-204 TEA

### URN CHAIN SIGNS

AVAILABLE IN SILVERTONE, INSCRIBED. SIGN WITH 24" LONG URN CHAIN IS SILVER WITH BLACK LETTERING. 4" W. x 2" H.



AC-49618 COFFEE  
AC-49619 DECAF  
AC-49620 HOT WATER

### TENT SIGNS (STAINLESS)

SOLD CASE OF ONE DOZEN.

ACT-100 BLANK  
ACT-101 COFFEE  
ACT-102 DECAF  
ACT-103 HOT TEA  
ACT-104 HOT WATER  
ACT-105 ICED TEA

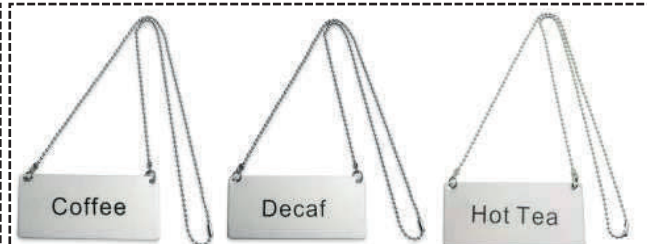
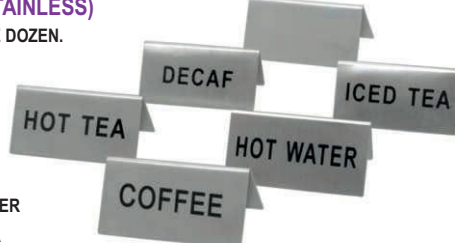

### CHAIN SIGNS (STAINLESS STEEL)

3.5" x 1.5". SOLD CASE OF 1 DOZ.



AC-49635 COFFEE SIGN  
AC-49636 DECAF SIGN  
AC-49637 HOT TEA SIGN  
AC-49638 HOT WATER SIGN  
AC-49639 ICED TEA SIGN



### SPIGOT DRIP TRAYS (ACRYLIC)

SILVER TRIM FRONT. AVAILABLE PLAIN OR INSCRIBED.

AC-49392 4" SQ. x 1" H. PLAIN  
AC-49632 4" SQ. x 1" H. COFFEE  
AC-49633 4" SQ. x 1" H. DECAF  
AC-49634 4" SQ. x 1" H. HOT WATER



### BLACK DRIP TRAYS (PLASTIC)

RK-3545 3.5" x 4.5",  
RK-3546 6" x 6"

RECTANGULAR  
OCTAGON

CASE PACK  
SET/12  
SET/12

## COFFEE URNS & COFFEE MAKERS



### COMMERCIAL COFFEE MAKERS (ALUMINUM)

- \* POLISHED ALUMINUM, ALL METAL CONSTRUCTION
- \* NON-DRIP FAUCET
- \* STAY-COOL HANDLES & KNOB
- \* 3 PRONG GROUNDED PLUG
- \* BREW VIEW GAUGE AND BREW INDICATOR LIGHT TO SIGNAL WHEN COFFEE IS BREWED
- \* TWIST-TO-SECURE COVER

CM-7003 12-55 CUPS



### COMMERCIAL COFFEE MAKERS (ALUMINUM)

- \* TWO WAY DRIPLESS SPIGOT
- \* TWIST TO SECURE COVER WITH STAY COOL PHENOLIC BASE, HANDLES AND KNOB
- \* SIGNAL LIGHT INDICATES WHEN COFFEE IS READY
- \* INTERIOR WATER LEVEL MARKINGS
- \* 36 CUPS LESS THAN 1 MINUTE A CUP
- \* 55 CUPS LESS THAN 40 MINUTE
- \* 100 CUPS LESS THAN 40 MINUTE

- 55 & 100 CUP MODEL FEATURES
- \* BREW VIEW GAUGE
  - \* DUAL, HIGH LIMIT THERMOSTAT TO PROTECT AGAINST OVERHEATING
  - \* ON/OFF SWITCH

CM-2100	100 CUPS	20" X 14 3/8" X 17 13/32"	1500 WATTS
CM-2101	55 CUPS	17 7/8" X 13 1/2" X 13 1/2"	1640 WATTS
CM-2102	36 CUPS	17 13/32" X 11 7/8" X 11 7/8"	1090 WATTS



**COFFEE MAKER (STAINLESS)**  
THESE COFFEE MAKERS ARE IDEAL FOR ANY EVENT. ALL PARTS ARE MADE OF DURABLE STAINLESS STEEL. THE UNIT IS EQUIPPED WITH A CLEAR WATER LEVEL GAUGE AND A RED INDICATOR LIGHT TO SIGNAL WHEN THE COFFEE IS DONE BREWING. AN AUTOMATIC TEMPERATURE CONTROL CONTINUOUSLY KEEPS THE COFFEE WARM AND READY TO SERVE.

120 V.

CM-7740	40 CUP
CM-7741	60 CUP
CM-7742	100 CUP

### COFFEE MAKER (ALUMINUM)

POLISHED ALUMINUM WITH NON-DRIP FAUCET AND STAY-COOL HANDLES AND KNOBS. BREW INDICATOR LIGHT LETS YOU KNOW WHEN THE COFFEE IS READY.

- \* TWO WAY DRIPLESS SPIGOT
- \* TWIST TO SECURE COVER WITH STAY COOL PHENOLIC BASE, HANDLES AND KNOB
- \* SIGNAL LIGHT INDICATES WHEN COFFEE IS READY
- \* INTERIOR WATER LEVEL MARKINGS
- \* 42 CUPS LESS THAN 1 MINUTE A CUP

CM-7030 30 CUP 16 1/2" x 10 5/8" x 10 3/4" 3 PRONG GROUNDED PLUG



### COMMERCIAL COFFEE MAKERS (ALUMINUM)

- \* POLISHED ALUMINUM, ALL METAL CONSTRUCTION
- \* NON-DRIP FAUCET
- \* STAY-COOL HANDLES & KNOB
- \* 3 PRONG GROUNDED PLUG
- \* BREW VIEW GAUGE AND BREW INDICATOR LIGHT TO SIGNAL WHEN COFFEE IS BREWED
- \* TWIST-TO-SECURE COVER

CM-7001 12-101 CUPS



### COFFEE MAKERS (STAINLESS STEEL)

THIS HIGH QUALITY STAINLESS STEEL WATER BOILER PROVIDES YOU MANY OPTIONS FOR HOT WATER USE WITH ITS LARGE 100 CUP CAPACITY. GREAT FOR THE OFFICE, RESTAURANT, CATERING, OR ANY EVENT THAT REQUIRES A HOT BEVERAGE.

- HIGH QUALITY STAINLESS STEEL CONSTRUCTION
- SPECIAL SENSOR HOLDS FINISHED LIQUID AT 183°F TO 188°F
- REMOVABLE SIGHT GLASS FOR EASY CLEANING
- LOCKING LID FOR SAFETY
- UL LISTED AND NSF4/ANSI LISTED
- 120 V, 1350 W

CM-1600	40 CUPS PERCOLATOR
CM-1601	60 - 80 CUPS PERCOLATOR
CM-1602	100 CUPS PERCOLATOR



### WATER BOILERS

THESE WATER BOILERS ARE AVAILABLE IN TWO SIZES, 50 OR 100 CUP AND IDEAL FOR BANQUET HALLS, CATERERS, HOTELS, AND RESTAURANTS.

- BRUSHED STAINLESS STEEL
- DOUBLE WALL STRUCTURE
- NON-DRIP CHROME-COATED WATER FAUCET
- EASY-TO-READ WATER GAUGE INDICATOR
- NON-SLIP RUBBER FEET
- CAN KEEP TEMPERATURES UP TO 210°F

WB-43400	50 CUP, 8.7" X 17.7" H., 1300 W
WB-43401	100 CUP., 10.6" X 20.5" H., 1500W

### HOT WATER BOILER (STAINLESS STEEL)

THIS HIGH QUALITY STAINLESS STEEL WATER BOILER PROVIDES YOU MANY OPTIONS FOR HOT WATER USE WITH ITS LARGE 100 CUP CAPACITY. GREAT FOR THE OFFICE, RESTAURANT, CATERING, OR ANY EVENT THAT REQUIRES A HOT BEVERAGE.

- HIGH QUALITY STAINLESS STEEL CONSTRUCTION
- SPECIAL SENSOR HOLDS FINISHED LIQUID AT 183°F TO 188°F
- REMOVABLE SIGHT GLASS FOR EASY CLEANING
- LOCKING LID FOR SAFETY
- UL LISTED AND NSF4/ANSI LISTED
- 120 V, 1350 W

WB-200 100 CUP CAPACITY

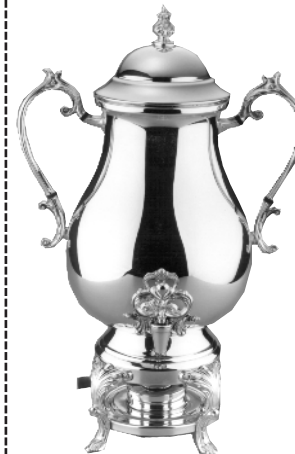

### IMPORTED URN (SILVERPLATE)

SOLD COMPLETE WITH FUEL HOLDER.

UR-242 25 CUP URN  
19" H. x 12" W. (ARM TO ARM)

UR-248 50 CUP URN  
22.75" H. x 14" W. (ARM TO ARM)

PT-642A	CUP/LID
FUL-213	3.5 OZ. FUEL, SET/48
PT-237	SPIGOT FOR 25/50 CUP URN



### COFFEE URN (18/8 STAINLESS)

THIS ROYAL CREST 3 GALLON COFFEE URN FEATURES AN ORNATE STYLE AND DESIGN. IT IS MADE OF 18/8 STAINLESS STEEL WITH A SATIN FINISH AND SOLID WOOD HANDLES. THE BODY IS REMOVABLE AND THE STAND IS ULTRA DURABLE FOR LONG LIFE. FEATURES INTRICATELY DETAILED LEGS, COVER, KNOB AND HANDLES. COMES COMPLETE WITH FUEL HOLDER.

UR-384 3 GAL.  
13.75" W. x 12" D. x 21" H.



### COFFEE URNS (STAINLESS)

EXTRA HEAVYWEIGHT. COFFEE URN IS MADE OF EXTRA HEAVYWEIGHT STAINLESS STEEL AND WILL HELP TURN YOUR BUFFET INTO THE ULTIMATE PRESENTATION! THE FINISH ON THIS URN IS EXTREMELY ELEGANT AND IT WILL CERTAINLY IMPRESS YOUR GUESTS AND CUSTOMERS. FEATURES BEAUTIFULLY DESIGNED LEGS, COVER, KNOB AND HANDLES TO COMPLIMENT A TRULY STUNNING COFFEE URN THAT WILL ENHANCE YOUR COFFEE SERVICE. A MUST FOR CATERING, HOTELS OR BANQUETS!

UR-908	3 GAL.	22" H. x 16" DIA.
UR-909	5 GAL.	26" H. x 17" DIA.



### COFFEE URN (STAINLESS)

MADE OF GOLD-ACCENTED STAINLESS STEEL, MIRROR POLISHED. COMES COMPLETE WITH FUEL HOLDER, DRIPLESS FAUCET, AND REMOVABLE LID AND BASE.

UR-300 3 GAL.  
22" L. x 11" OUTSIDE DIA.



### ROYAL DANISN™ COFFEE URN (18/10 STAINLESS)

THIS 3 GALLON COFFEE URN ARE EXTREMELY ELEGANT AND IDEAL FOR PRESENTATION! MADE OF HEAVY-GAUGE, 18/10 STAINLESS STEEL WITH A MIRROR FINISH. THESE COFFEE URN ARE A MUST FOR CATERING AND BANQUETS! COMES WITH A FUEL HOLDER. HOTEL QUALITY.

UR-295 3 GAL. (50 CUPS) GOLD KNOBS



### WALCO COFFEE URNS WITH BASE AND FUEL HOLDER

HEAVY WEIGHT STAND.

UR-311	1.5 GAL.
UR-312	3 GAL.
UR-319	5 GAL.

LD-312 URN LID FOR UR-312 AND UR-319  
PT-312 URN SPIGOT FOR UR-312 AND UR-319



### NEW YORK COFFEE URNS (18/8 STAINLESS)

MADE OF BRILLIANT, MIRROR FINISHED, 18/8 STAINLESS STEEL. FEATURES CLEAR COATED BRASS TRIM TO DETER DISCOLORATION, DURABLE SOLID LEGS AND WELDED CONSTRUCTION. REMOVABLE FAUCET. HINGED COVER.

UR-46293	3 GAL.	12.75" W. x 13" D. x 19.75" H.
UR-46294	5 GAL.	15.5" W. x 16.5" D. x 21.75" H.



## COFFEE URNS

### VIRTUOSO COFFEE URNS (MIRROR FINISH STAINLESS)

INCLUDES FUEL HOLDERS. EXTRA HEAVYWEIGHT.

5 GALLON: 14.75" L. x 13.25" W. x 21.75" H.

3 GALLON: 15" L. x 13.38" W. x 20.88" H.



- URG-1200 3 GAL., STAINLESS WITH GOLD LEG
- URG1201 5 GAL., STAINLESS WITH GOLD LEG
- UR-1200 3 GAL., STAINLESS
- UR-1201 5 GAL., STAINLESS

### ALLEGRO COFFEE URNS(STAINLESS STEEL)

EACH ONE COMES COMPLETE WITH A FUEL HOLDER AND DURABLE FAUCET.

PERFECT FOR RESTAURANTS, HOTELS AND CATERERS!

11 QUART (44 CUPS), 11 1/8" DIA. x 19 3/4" H.



UR-920 STAINLESS WITH GOLD ACCENTS

UR-921 ALL STAINLESS

### NOBLESSE™ COFFEE URNS (18/10 STAINLESS)

THESE 18/10 STAINLESS STEEL SAMOVARs HAVE A CLEAN, SLEEK DESIGN THAT WILL ENHANCE ANY COFFEE SERVICE APPLICATION! EACH ONE WILL SUSTAIN BEVERAGE TEMPERATURES PERFECTLY. ALSO COMES WITH A FUEL HOLDER. EXTREMELY BEAUTIFUL AND PERFECT FOR DISPENSING COFFEE AT A VARIETY OF EVENTS AND FUNCTIONS. MULTIPLE SIZES AVAILABLE TO MEET ALL OF YOUR FOODSERVICE NEEDS.

- UR-2052 1.5 GAL. 24 CUP 17" H.
- UR-2053 3 GAL. 48 CUP 23.5" H.
- UR-2054 5 GAL. 80CUP 26.5" H.



### COFFEE URNS(STAINLESS)

THIS MIRROR FINISH STAINLESS STEEL COFFEE URN IS AN UPDATED VERSION OF THE TRADITIONAL SILVERPLATED OPTIONS. THE STAINLESS STEEL IS DURABLE AND WILL HOLD UP TO YOUR TOUGHEST EVENTS, BUT EXPERTLY DESIGNED TO COMBINE FORM AND FUNCTION, HELPING YOU CREATE AN ELEGANT SETTING AT YOUR NEXT EVENT.



- UR-4635310 3 GAL. 13" x 13 1/2" x 22"
- UR-4635510 5 GAL. 13" x 13 1/2" x 27 3/8"

### EVOLUTION COFFEE URN (STAINLESS STEEL)

THE COFFEE URN IS A SOLID STAINLESS STEEL. THIS LINE IS HIGH QUALITY AND BEAUTIFUL.



- UR-2205 12 QT., 11" L. x 13 3/8" W. x 21 1/4" H.

### BRASS TRIM COFFEE URN

THIS 3 GALLON COFFEE URN IS MADE OF 18/8 MIRROR FINISH STAINLESS STEEL WITH BRASS TRIM. THE BRASS TRIM IS CLEAR COATED TO HELP PREVENT DISCOLORATION. FAUCET REMOVES FOR EASY CLEANING.



- UR-46029 3 GAL., 12.75" x 12" x 21.75"

## FLAME FREE



GOLD TRIM

CHROME TRIM

### LION INSULATED COFFEE URNS (STAINLESS)

THESE LION INSULATED COFFEE URNS ARE AN EASY WAY TO SPICE UP YOUR NEXT BEVERAGE SERVICE. EACH URN IS MADE OF STAINLESS STEEL AND IS AVAILABLE WITH YOUR CHOICE OF GOLD, CHROME OR COPPER TRIM. THE HANDLES AND FEET OF EACH URN HAVE AN ELEGANTLY CRAFTED LION'S HEAD, INSTANTLY ADDING SOMETHING SPECIAL TO ANY EVENT.

- UR-48000 1.5 GAL. STAINLESS WITH GOLD TRIM
- URC-48000 1.5 GAL. STAINLESS WITH CHROME TRIM
- UR-48001 3 GAL. STAINLESS WITH GOLD TRIM
- URC-48001 3 GAL. STAINLESS WITH CHROME TRIM
- UR-48002 5 GAL. STAINLESS WITH GOLD TRIM
- URC-48002 5 GAL. STAINLESS WITH CHROME TRIM

### LION NON - INSULATED COFFEE URNS

- UR-48100 1.5 GAL. STAINLESS WITH GOLD TRIM
- URC-48100 1.5 GAL. STAINLESS WITH CHROME TRIM
- UR-48101 3 GAL. STAINLESS WITH GOLD TRIM
- URC-48101 3 GAL. STAINLESS WITH CHROME TRIM
- UR-48102 5 GAL. STAINLESS WITH GOLD TRIM
- URC-48102 5 GAL. STAINLESS WITH CHROME TRIM

## FLAME FREE



### CONTEMPORARY INSULATED COFFEE URNS (STAINLESS STEEL)

THESE CONTEMPORARY, INSULATED STAINLESS STEEL COFFEE URNS ARE A PERFECT ADDITION TO YOUR NEXT BEVERAGE SERVICE! AVAILABLE IN VARIETY OF SIZES, EACH ONE COMES WITH YOUR CHOICE OF CHROME OR COPPER TRIM. ALL OF THE URNS HAVE A MODERN, STREAMLINED DESIGN AND DO NOT REQUIRE OUTSIDE HEAT SOURCES TO STAY WARM. PERFECT FOR ANY BANQUET FACILITY!

- URC-42000 1.5 GAL. STAINLESS WITH CHROME TRIM
- URC-42001 3 GAL. STAINLESS WITH CHROME TRIM
- URC-42002 5 GAL. STAINLESS WITH CHROME TRIM

### CONTEMPORARY NON - INSULATED COFFEE URNS

- URC-42100 1.5 GAL. STAINLESS WITH CHROME TRIM
- URC-42101 3 GAL. STAINLESS WITH CHROME TRIM
- URC-42102 5 GAL. STAINLESS WITH CHROME TRIM

## FLAME FREE



GOLD TRIM

CHROME TRIM

### ROMAN INSULATED COFFEE URNS

THESE ROMAN INSULATED COFFEE URNS ARE A GREAT WAY TO TAKE YOUR BEVERAGE SERVICE TO THE NEXT LEVEL. EACH URN IS AVAILABLE IN A VARIETY OF SIZES AND IN YOUR CHOICE OF STAINLESS WITH GOLD TRIM, WITH COPPER TRIM OR WITH CHROME TRIM. EACH ONE HAS ELEGANTLY STYLED FEET AND HANDLES, WITH A BEAUTIFUL, FILIGREED SPIGOT DISPENSER. PERFECT FOR RESTAURANTS AND CATERERS!

- UR-49000 1.5 GAL. STAINLESS WITH GOLD TRIM
- URC-49000 1.5 GAL. STAINLESS WITH CHROME TRIM
- UR-49001 3 GAL. STAINLESS WITH GOLD TRIM
- URC-49001 3 GAL. STAINLESS WITH CHROME TRIM
- UR-49002 5 GAL. STAINLESS WITH GOLD TRIM
- URC-49002 5 GAL. STAINLESS WITH CHROME TRIM

## BEVERAGE DISPENSERS

### BEVERAGE DISPENSERS

INCLUDES TRANSLUCENT LID AND ICED TEA, LEMONADE, FRUIT PUNCH, SWEETENED TEA, AND UNSWEETENED TEA LABELS. MADE IN USA. COLORS: TRANSLUCENT POLYPROPYLENE CONTAINER WITH BLACK(03) OR BROWN(01) BASE & LID.

UR-1545 3 GAL., SQUARE  
11" W. x 12.5" D. x 17" H.  
BLACK ONLY

UR-1546 5 GAL., ROUND  
12.37" DIA. x 21.5" H.

UR-1547 3 GAL., ROUND  
12.3" DIA. x 14.75" H.  
BROWN ONLY



### BEVERAGE DISPENSER (GLASS)

THIS COMPLETE SET INCLUDES A 2 GALLON BEVERAGE CHAMBER, ICE CHAMBER, BLACK WIRE BASE, LID, DRIP TRAY AND AN EASY FLOW SPIGOT. THE ICE CHAMBER IS REMOVABLE AND CHILLS BEVERAGES WITHOUT DILUTING THEM. THE STEEL BASE FEATURES CURLED FEET AND REALLY ADDS AN ELEGANT TOUCH, WHILE THE FAUX GLASS BEVERAGE CHAMBER IS EXTREMELY STUNNING!

UR-1659 2 GAL.  
22" H. x 9 1/2" W.



### SIMPLE DRINK DISPENSER

THIS DRINK SERVER HOLDS A GENEROUS FIVE-GALLON LIQUID CAPACITY. THE DRINK UNIT IS SEATED SECURELY ON A BLACK ACRYLIC RISER BASE. FILL WITH ICE, AND DRINKS STAY COLD ALL DAY LONG. SPOUT AND BASE INCLUDED.

DS-950 5 GAL.  
22.5" x 9.5" x 12"



### JUICE DISPENSER

ACRYLIC BODY WITH STAINLESS STEEL TOP & GOLD ACCENTS ON A STAINLESS STEEL BASE.

UR-75 2.5 GAL.  
19.5" H. x 10.75" DIA.

UR-85 5 GAL.  
24.5" H. x 12.25" DIA.



### FAUX GLASS DISPENSER

THIS COMPLETE SET INCLUDES A BEVERAGE CHAMBER, ICE CHAMBER, BLACK WIRE BASE, LID, DRIP TRAY AND AN EASY FLOW SPIGOT. THE ICE CHAMBER IS REMOVABLE AND CHILLS BEVERAGES WITHOUT DILUTING THEM. THE STEEL BASE FEATURES CURLED FEET AND REALLY ADDS AN ELEGANT TOUCH, WHILE THE FAUX GLASS BEVERAGE CHAMBER IS EXTREMELY STUNNING!

AC-9322 2 GAL., 20" H. x 10" W.  
AC-9323 3 GAL., 22" H. x 11" W.



### COLD BEVERAGE DISPENSERS WITH ICE CHAMBER (ACRYLIC)

PACIFICA STYLE OCTAGON BEVERAGE DISPENSERS ARE EYE CATCHING AND FUNCTIONAL. THIS COMPLETE SET INCLUDES AN ACRYLIC BEVERAGE CHAMBER, ICE CHAMBER, ACRYLIC BASE, LID, DRIP TRAY AND AN EASY FLOW SPIGOT. THE ICE CHAMBER IS REMOVABLE AND CHILLS BEVERAGES WITHOUT DILUTING THEM. IDEAL FOR A VARIETY OF FUNCTIONS AND EVENTS!!

AC-49981 2 GAL., 10" W. x 11" D. x 20" H.  
AC-49972 3 GAL., 11" W. x 11" D. x 22" H.

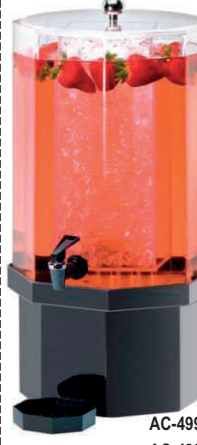

### PLASTIC BEVERAGE DISPENSERS

THESE 3 GALLON PLASTIC BEVERAGE DISPENSERS ARE AVAILABLE WITH A STANDARD PLASTIC DISPENSER OR A CRYSTAL CLEAR TRITAN DISPENSER. BOTH INCLUDE A REMOVEABLE INFUSER TUBE. DISHWASHER SAFE.

UR-330 PLASTIC  
UR-331 TRITAN PLASTIC



### COLD BEVERAGE DISPENSERS (BRUSHED STAINLESS & BPA FREE TRITAN PLASTIC BODY)

BPA FREE TRITAN PLASTIC RESERVOIR AND STAINLESS STEEL BASE AND COVER PROVIDES DURABLE QUALITY FOR COMMERCIAL USE. EASY TO USE WITH ANY GLASS UP TO 8.5" TALL. NSF CERTIFIED.

UR-175 3.5 GALLON  
11" L. x 12" W. x 22" H.

UR-176 5 GALLON  
13.75" L. x 14.25" W. x 23" H.



### BEVERAGE DISPENSERS

3 GALLON BEVERAGE DISPENSERS FEATURE BPA-FREE PLASTIC BODY AND STAINLESS HYDRO-DIPPED LID AND BASE. DISHWASHER SAFE. 12" L. x 11" W. x 22" H.

UR-320DW DARK WOOD  
UR-320LW LIGHT WOOD  
UR-320TM TRAVERTINE MARBLE



### JUICE DISPENSER

POLYCARBONATE BODY AND STAINLESS LID. ICE TUBE TO KEEP BEVERAGES COLD. COLD USE ONLY!

DS-75100  
10 L. (10.5 QT.)



### BEVERAGE DISPENSERS (STAINLESS)

SIMPLY LIFT OFF THE LID AND POUR YOUR FAVORITE BEVERAGE IN. FEATURES HEAVY DUTY TOMLINSON FAUCETS FOR EXCELLENT DISPENSING OF ICED COFFEE, TEA, FRUIT PUNCH, LEMONADE, ETC.

UR-2064 3 GAL. 9.25" DIA. x 21" H.  
UR-2065 5 GAL. 9.25" DIA. x 26" H.



### SPACE SAVER ICED TEA DISPENSERS

STAINLESS STEEL ICED TEA DISPENSERS ARE AVAILABLE IN YOUR CHOICE OF TRADITIONAL STYLE WITH AN ICE CORE OR A NARROW, SPACE SAVING DESIGN. ICED TEA DISPENSERS ARE GREAT FOR INDOOR OR OUTDOOR EVENTS AND MAKE EXCELLENT ADDITIONS FOR ANY RESTAURANT, HOTEL OR CATERER.

ITD-500 5 GAL., 18.9 L. x 6.9" W. x 21.3 H.  
ITD-530 3 GAL., 13.8" L. x 6.9" W. x 21.1" H.



### ICED TEA DISPENSER WITH ICE CORE CENTER

SATIN FINISH STAINLESS. GREAT FOR INDOOR OR OUTDOOR EVENTS.

ITD-300 3 GAL.  
16.5" H. x 15.5" (INCLUDING HANDLES)



### JUICE DISPENSER

ACRYLIC BODY WITH STAINLESS STEEL TOP & GOLD ACCENTS ON A STAINLESS STEEL BASE.

UR-485 3 GAL.  
15.5" L. x 12.5" W. x 23.3" H.



### BEVERAGE DISPENSERS (POLYCARBONATE)

THE BASES ARE A HAMMERED STAINLESS STEEL OR WROUGHT IRON AND FIT BOTH SIZE BODIES. FEATURE ICE INSERTS. SWITCH THEM UP TO MATCH ANY OCCASION. REPLACEMENT PARTS AVAILABLE.

UR-350 3 GALLON BEVERAGE DISPENSER, 11" X 10 1/4" X 19 3/4" H.  
UR-351 5 GALLON BEVERAGE DISPENSER, 12 1/2" X 12" X 20 1/2" H.  
UR-352 HAMMERED STAINLESS STEEL BASE, FOR UR-350 AND UR-351  
UR-353 WROUGHT IRON BASE FOR UR-350 AND UR-351



### CRYSTAL DRINK DISPENSER

THE ONE-PIECE BEVERAGE DISPENSER SITS ON A SQUARE PEDESTAL STYLE FOOT WITH A LIFT OFF COVER FOR EASY FILLING.

DS-257631  
1 GALLON  
7.32" DIA. X 20.28" H.



# BEVERAGE DISPENSERS & ACCESSORIES



**GLASS MASON JAR BEVERAGE DISPENSER WITH CHALKBOARD NECKLACE**  
THE UNIT COME COMPLETE WITH NECKLACE, ICE CORE, AND INFUSER.

UR-727 2 GALLON  
7.75" L. x 10.25" W. x 12.25" H.



**GLASS COUNTRY BEVERAGE DISPENSER WITH CHALKBOARD NECKLACE**  
THE UNIT COMES COMPLETE WITH A CHALKBOARD NECKLACE TO LABEL.

UR-726  
2 GALLON  
10 3/4" DIA. x 16 1/4" H.



**GLASS BEEHIVE BEVERAGE DISPENSER WITH CHALKBOARD NECKLACE**  
THE UNIT COME COMPLETE WITH NECKLACE, ICE CORE, AND INFUSER.

UR-725  
2.5 GALLON  
10 3/4" DIA. x 16 1/4" H.



**PEDESTAL BEVERAGE SERVER**  
EASY TO FILL PEDESTAL SERVER. GREAT FOR SERVING SANGRIA, PUNCH, WATER, OR ANY REFRESHMENTS. TALL HEIGHT ALLOWS FOR EASY FILLING OF TALL GLASSES. MUST BUY IN CASE PACKS OF 2 EACH.

UR-67008  
1.7 GALLON  
18" H.



**COLD BEVERAGE DISPENSER WITH INFUSER (BPA FREE PLASTIC)**  
COMES COMPLETE WITH AN INFUSER TO ADD FLAVOR TO YOUR BEVERAGE. CAN BE USED WITH ANY GLASS UP TO 4.75" TALL. HAND WASH ONLY.

UR-1500 1.5 GAL.  
10" DIA. x 14" H.



**BON BON GLASS BEVERAGE DISPENSER**  
OFFERS AN ELEGANT PRESENTATION FOR ANY BEVERAGE SERVICE. FEATURES A STAINLESS SPIGOT AND REMOVABLE TOP.

UR-9001  
1.5 GALLON,  
15 1/4" H.



**INFUSION JARS WITH SCREW TOP LID (GLASS)**  
THEN BREAK OUT THE INFUSION JAR. DISPLAY YOUR LEMONADE, ICED TEA, OR ANY COLD BEVERAGE IN THIS GREAT JAR THAT WILL ADD A GREAT COUNTRY LOOK.

UR-9100  
4.375 QT. (140 OZ.)  
10" H. X 4 1/4" T. X 5 3/4" B.  
UR-9101  
6.5 QT. (210 OZ.)  
12" H. X 5" T X 7" B.



**INFUSION JARS WITH CLAMP (GLASS)**  
THEN BREAK OUT THE INFUSION JAR. DISPLAY YOUR LEMONADE, ICED TEA, OR ANY COLD BEVERAGE IN THIS GREAT JAR THAT WILL ADD A GREAT COUNTRY LOOK.

UR-9102  
5 QT. (160 OZ.)  
12" H. X 3 1/2" T. X 6 1/2" B.  
UR-9103  
9.375 QT. (1600 OZ.)  
14 1/2" H. X 4 1/2" T. X 7 1/2" B.



**EVOLUTION SQUARE COLD BEVERAGE DISPENSER**  
THE COLD BEVERAGE DISPENSER HAS A POLYCARBONATE BODY WITH AN OFFSET ICE RESERVOIR FOR EASY FILL AND REFILL.

DS-2204  
12 QT.  
11" L. x 12" W. x 23 1/8" H.

DSF-2200  
REPLACEMENT FAUCET



**DRINK AND CEREAL DISPENSERS ON ROTATING BASE**

THIS ROTATING DISPLAY COMES WITH YOUR SELECTION OF DISPENSERS FOR LIQUID OR DRY CONTENTS, SEATED ON AN ELEVATED BASE. ONE GALLON CAPACITY LIQUID DISPENSERS ARE OUTFITTED WITH SPIGOTS AND ICE CUBE TUBES. CAN BE CHANGED FOR CUSTOM SETUPS!

- DS-8800 12.5" H. x 5.5" W. x 10" D. SINGLE DRINK HOLDER
- DS-8801 12.5" H. x 5.5" W. x 5.5" D. SINGLE DRINK HOLDER
- DS-8802 ROTATING BASE
- DS-8803 12.5" H. x 14" W. x 14" D. 3 DRINK HOLDERS & BASE
- DS-8804 12.5" H. x 14" W. x 14" D. 6 CEREAL HOLDERS & BASE
- DS-8805 12.5" H. x 14" W. x 14" D. 2 DRINK, 2 CEREAL & BASE
- DS-8806 12.5" H. x 14" W. x 14" D. 1 DRINK, 4 CEREAL & BASE



**GALVANIZED TUB/BASE**

USE AS A RUSTIC TUB FOR STORAGE OR IT CAN BE FLIPPED OVER TO SERVE AS A BASE TO UR-725 AND UR-726 FOR ADDED HEIGHT.

URT-725 7.5" H.



**METAL BAND BEVERAGE DISPENSERS**  
THESE DISPLAY TANKS AND BASES ARE MADE OF POLYCARBONATE SO DISPENSERS ARE DURABLE AND LIGHTWEIGHT. THE SPIGOT IS REMOVABLE FOR EASY CLEANING. COMES WITH A DRIP TRAY FOR A NO MESS SOLUTION.  
8" W. X 10" D. X 24" H. 3 GALLON SIZE

- UR-2015 ICE CHAMBER AND BLACK BAND
- UR-2016 INFUSION CHAMBER AND BLACK BAND
- UR-2017 ICE CHAMBER AND SILVER BAND
- UR-2018 INFUSION CHAMBER AND SILVER BAND

**IDOL MILK DISPENSER (STAINLESS STEEL)**

MD-320 1.5 GALLON



**STAINLESS STEEL BEVERAGE DISPENSERS**

THESE DISPLAY TANKS ARE MADE OF POLYCARBONATE SO IT IS ALSO A LIGHTWEIGHT UNIT. THE SPIGOT, CHAMBER, LID, AND BASE ARE REMOVABLE FOR EASY CLEANING. IT ALSO COMES WITH A DRIP TRAY FOR A NO MESS SOLUTION.  
7 1/2" W. X 9 1/2" D. x 23 1/2" H.  
3 GALLON

**CHOOSE ICE OR INFUSION**

- UR-3320 ICE CHAMBER
- UR-3321 INFUSION CHAMBER



**MILK DISPENSER**  
THIS MILK DISPENSER HAS A MIRRORRED FINISH AND IS MADE OF STAINLESS STEEL.

MK-4635110  
5 QT. CAPACITY  
8" x 12 7/8" x 16 3/8" H.



**ROSEWOOD FINISH WOOD TEA CHEST**  
THIS HINGED WOOD BOX FEATURES A ROSEWOOD COLORED FINISH AND A CREAM COLOR CLOTH LINED INTERIOR. IT IS PARTITIONED INTO SIX COMPARTMENTS TO HOLD YOUR DIFFERENT TEA BAG OPTIONS.

TCW-6980 9" X 6.25" X 3.75"



**TEA STRAINER AND HOLDER (STAINLESS)**

TS-600 2.5" x 1.5"



**FRENCH PRESS**

- CASE PACK
- FPS-200 17 OZ., 2-CUP FRENCH PRESS 12 EACH
  - FPS-201 2 CUP REPLACEMENT GLASS
  - FPS-400 34 OZ., 4-CUP FRENCH PRESS 12 EACH
  - FPS-401 4 CUP REPLACEMENT GLASS



**WOODEN TEA CHEST**  
WOODEN TEA BAG CHEST WITH SILVERPLATED ACCENTS.

AC-20420

**6 COMPARTMENT TEA CHEST (PLASTIC)**  
THIS WOODEN TEA CHEST HAS A SEE-THROUGH COVER AND MATTE BLACK FINISH.

TCW-600 9.25" x 6.25" x 3.5"



## BEVERAGE SERVERS



### SWIRL SERVING CARAFES

MADE OF HIGH IMPACT PLASTIC, INSULATED BODY WITH PUSH BUTTON LIDS, REMOVABLE DECAF ORANGE TAG.

AC-731	20 OZ.	5.1" L. x 5.4" W. x 8.3" H.	WHITE
AC-732	20 OZ.	5.1" L. x 5.4" W. x 8.3" H.	BLACK
AC-733	42 OZ.	6.5" L. x 6.5" W. x 10.4" H.	WHITE
AC-734	42 OZ.	6.5" L. x 6.5" W. x 10.4" H.	BLACK
AC-737	64 OZ.	7.4" L. x 6.9" W. x 11.5" H.	WHITE
AC-738	64 OZ.	7.4" L. x 6.9" W. x 11.5" H.	BLACK



### METALLIC LUSTER® CARAFES

FEATURES A PUSH BUTTON LID AND VACUUM, FOAM INSULATION THAT HOLDS TEMPERATURES FOR 2-3 HOURS. HAS A PLASTIC CONSTRUCTED BODY WITH A CHROME FINISH, AND A BLACK BASE AND LID. DISHWASHER SAFE.

AC-12280	20 OZ.	8" x 4 1/2"
AC-12281	33 OZ.	9 1/4" x 5"
AC-12282	50 OZ.	11 3/4" x 5"



### PUSH-BUTTON VACUUM SERVER WITH COLOR BOX

BLACK/BRUSH FINISH. HEAT RETENTION: 10 HRS @ 173°F OR 24 HRS @ 144°F. SIZE: 6.6" L. x 6.6" W. x 17.9" H.

AC-4309	3 L.
AC-4309DC	3 L., DECAF



### VACUUM SERVERS

PUSH BUTTON AIRPOT STAINLESS BODY AND STAINLESS STEEL LINED. HEAT RETENTION: 10 HRS @ 173°F, AND 24 HRS @ 144°F. 2.5 LT SIZE: 6.8" L. x 6.8" W. x 15.8" H. 3.0 LT SIZE: 6.9" L. x 6.9" W. x 17.5" H.

AC-6791	2.5 LT.
AC-6792	3.0 LT.



### GOLD SERVER

PC LINED AND POLYURETHANE FOAM INSULATED. SERVER IS FOAM INSULATED AND HAS A BLACK TRIM BRUSHED GOLD BODY AND A HIGH IMPACT PLASTIC BOTTOM AND TOP FOR LONG LASTING LIFE AND DURABILITY.

AC-643	20 OZ.
AC-644	32 OZ.
AC-645	64 OZ.



### AUTOPOUR SERVER (BRUSHED COPPER BODY W/BLACK BASE, HANDLE AND LIP)

AUTOPOUR SERVERS ARE AN EXCELLENT CHOICE FOR ANY RESTAURANT, HOTEL, DINER OR COFFEE SHOP. URC-33 33 OZ. CAPACITY



### VACUUM INSULATED SLIMLINE SERVERS (STAINLESS STEEL BODY, PLASTIC HANDLE)

THE SERVERS HAVE A HANDS-FREE FLIP LID, PROVIDING FAST AND SANITARY SERVICE.

AC-87001	24 OZ.
AC-87002	33 OZ.



### CARAFE SERVERS BLACK & STAINLESS

STAINLESS STEEL SERVERS ARE COMPACT AND LIGHTWEIGHT. IDEAL FOR SELF SERVICE ENVIRONMENTS, THESE ARE GREAT FOR CREAM BUT CAN ALSO BE USED FOR COFFEE OR TEA.

AC-87005	24 OZ.
AC-87006	33 OZ.



### VACUUM SERVERS

GLASS LINED STAINLESS BODY VACUUM SERVER. BLACK/BRUSH FINISH AIRPOT.

AC-4306	74 OZ., 2.2 L.
AC-4307	84 OZ., 2.5 L.
AC-4306DC	74 OZ., 2.2 L., DECAF
AC-4307DC	84 OZ., 2.5 L., DECAF



### VACUUM INSULATED THERMAL CARAFES

STAINLESS STEEL VACUUM INSULATED LINERS FOR GREATER DURABILITY, DRIP FREE POURING SPOUTS, WIDE, STABLE BASES, COME WITH TWIST-OFF AND TRIGGER LIDS.

AC-9111	1 LITER
AC-91112	1.5 LITER



### COFFEE POURER (STAINLESS W/ GOLD HANDLE)

BRIGHT POLISH STAINLESS POURER WITH FOAM INSULATION. STAINLESS STEEL- LINED AND NON-BREAKABLE.

ACG-6680	50 OZ.
ACG-6681	33 OZ.



### INSULATED SERVERS (MIRROR FINISH STAINLESS)

VACUUM INSULATED WITH BREAK RESISTANT, STAINLESS STEEL LINER. HOLDING TIME OF 4 TO 6 HOURS. EASY ONE-HANDED OPERATION. SOLD IN CASE PACKS ONLY!

ACSS-27	27 OZ.	PKG 12
ACSS-33	33 OZ.	PKG 6
ACSS-50	50 OZ.	PKG 6



### COFFEE SERVERS (STAINLESS STEEL)

MADE FROM DURABLE STAINLESS STEEL, THIS SERVER IS RESISTANT TO RUST AND WILL WITHSTAND HIGH VOLUME SERVICE WITHOUT WARPING. IT FEATURES A PLASTIC HANDLE AND PUSH BUTTON TOP TO ALLOW FOR A ONE-HANDED USE.

ACSS-012	1.2 L./40 OZ., PUSH BUTTON TOP
ACSS-015	1.5 L./51 OZ., PUSH BUTTON TOP
ACSS-019	1.9 L./64 OZ., PUSH BUTTON TOP
ACSS-020	1.9 L./64 OZ., BRU-THRU LID



### VANGUARD HOLLOWARE (18/10 STAINLESS)

TE-611	34 OZ. COFFEE POT
TE-622	68 OZ. WATER PITCHER
TE-628	5 OZ. MILK JUG



### AIRPOTS, LEVER TOP (GLASS LINED, STAINLESS)

HEAT RETENTION: 10 HOURS AT 173°F OR 24 HOURS AT 144°F. VACUUM SEAL MEANS THAT BEVERAGES STAY AT THEIR OPTIMUM SERVING TEMPERATURES FOR HOURS.

AC-9450	2.2 L.
AC-9451	2.5 L.
AC-9452	3 L.



### CARAFE (STAINLESS STEEL)

STAINLESS STEEL VACUUM INSULATED THERMAL CARAFE HAS A STAINLESS STEEL LINER FOR ADDED DURABILITY. THE CARAFE ALSO HAS A DRIP FREE SPOUT AND SLIM DESIGN. SOLD WITH TWIST OFF AND TRIGGER LIDS.

AC-9115	1.5 L.
---------	--------



### BEVERAGE SERVER (STAINLESS)

DISHWASHER SAFE. WILL NOT TARNISH OR RUST. THE PITCHER HAS A 64 OZ. CAPACITY WITH A FLIP-TOP COVER.

ACSS-9501	64 OZ.
-----------	--------



### GOOSENECK TEAPOTS (STAINLESS)

ACSS-2920	20 OZ.
ACSS-2932	32 OZ.



### TEAPOT WITH INFUSER

THIS TEAPOT COMES WITH ITS OWN INFUSER. THE TEAPOT IS 25 OZ AND MADE OF GLASS. THE INFUSER IS STAINLESS STEEL. SOLD IN CASE PACK OF 12 EACH ONLY.

TP-7500	25 OZ.
---------	--------



### HAMMERED GOOSENECK SERVER (STAINLESS STEEL)

ACSS-710	10 OZ.
	4.25" H.



### BEVERAGE SERVERS (STAINLESS)

FEATURES A STURDY HANDLE, HINGED LID AND AN EASY POUR SPOUT FOR SERVICE.

ACSS-1255	70 OZ.
ACSS-1256	32 OZ.
ACSS-1257	12 OZ.



### 3 PC SUGAR CREAMER SET WITH TRAY (HIGH POLISHED 18/8 STAINLESS STEEL)

6 OZ. CREAMER AND 5 OZ. SUGAR BOWL. THE TRAY IS 7.5" X 4.25". SOLD AS A SET ONLY. DISHWASHER SAFE.

TE-554
--------



### GOOSENECK TEAPOTS & SERVERS (STAINLESS)

AC-87010	10 OZ.
AC-87011	20 OZ.
AC-87012	32 OZ.
AC-87013	48 OZ.



### SERVING PIECES (STAINLESS STEEL)

STAIN FINISH. COFFEE POT, SUGAR BOWL AND TEAPOT HAVE HINGED LIDS. SOLD IN CASE PACKS OF 6.

ACSS-808	10 OZ.	CREAMER
ACSS-809	12 OZ.	SUGAR BOWL
ACSS-810	12 OZ.	TEAPOT
ACSS-811	68 OZ.	WATER PITCHER W/ICE GUARD
ACSS-812	68 OZ.	COFFEE POT



### STAINLESS HAMMERED FROTHING PITCHER (STAINLESS STEEL)

ACSS-72400	14 OZ.
	3" DIA. X 3.75" H.

**BEVERAGE SERVERS, CREAMERS, & SUGAR BOWLS**

**STILETTO COLLECTION**



STILETTO COLLECTION (18/10 STAINLESS)  
BRUSHED FINISH.

ONEIDA

ACSS-88609	17 OZ.	COFFEE POT, SHORT SPOUT
ACSS-88661	44 OZ.	COFFEE POT, LONG SPOUT
ACSS-88671	68 OZ.	COFFEE POT, LONG SPOUT
ACSS-88111	5 OZ.	CREAMER WITHOUT COVER
ACSS-88309	9 OZ.	CREAMER WITHOUT COVER
ACSS-88161	5 OZ.	CREAMER WITH COVER
ACSS-88307	9 OZ.	CREAMER WITH COVER
ACSS-88421	12 OZ.	SUGAR BOWL WITH COVER
ACSS-88801	9 OZ.	TEAPOT, SHORT SPOUT
ACSS-88821	17 OZ.	TEAPOT, SHORT SPOUT
ACSS-88631	68 OZ.	WATER PITCHER WITHOUT ICE GUARD
ACSS-88731	68 OZ.	WATER PITCHER WITH ICE GUARD

**SOPRANO COLLECTION**



THE SOPRANO COLLECTION (18/8 STAINLESS)  
HIGH POLISH FINISH, HEAVY DUTY HOTEL GRADE SERVERS.

ACSS-9260	70 OZ.	GOOSENECK COFFEE
ACSS-9266	70 OZ.	WATER PITCHER W/GUARD
ACSS-9261	30 OZ.	GOOSENECK COFFEE
ACSS-9262	18 OZ.	GOOSENECK COFFEE
ACSS-9263	12 OZ.	GOOSENECK COFFEE
ACSS-9264	20 OZ.	GOOSENECK TEA
ACSS-9265	12 OZ.	GOOSENECK TEA
ACSS-9267	10 OZ.	SUGAR BOWL WITH LID
ACSS-9268	10 OZ.	SUGAR BOWL WITHOUT LID
ACSS-9269	5 OZ.	CREAMER, WITHOUT LID, WITH HANDLE
ACSS-9270	5 OZ.	CREAMER, WITH LID, WITH HANDLE
ACSS-9271	5 OZ.	CREAMER, WITHOUT LID, WITHOUT HANDLE
ACSS-9272	12 OZ.	CREAMER, WITHOUT LID, WITH HANDLE
ACSS-9273	70 OZ.	WATER PITCHER WITHOUT ICE, WITH HANDLE

**OPERA™ COLLECTION**



ONEIDA

SANT' ANDREA®, OPERA™ COLLECTION (18/10 STAINLESS)  
DURABLE AND TIMELESS WITH SEAMLESS TIPS AND EDGES.

ACSS-60661	64 OZ.	COFFEE POT, LONG SPOUT
ACSS-61111	5 OZ.	CREAMER
ACSS-61131	10 OZ.	CREAMER
ACSS-64421	10 OZ.	SUGAR BOWL WITH COVER
ACSS-64461	10 OZ.	SUGAR BOWL WITHOUT COVER
ACSS-64801	10 OZ.	TEAPOT
ACSS-64821	20 OZ.	TEAPOT
ACSS-65731	64 OZ.	PITCHER WITH ICE GUARD

**TRIENNIUM™ COLLECTION**



TRIENNIUM™ BEVERAGE SERVERS (18/8 STAINLESS)  
SATIN FINISH.

AC-46200	10 OZ. x 7.875" H.	COFFEE POT
AC-46203	2.3 QT. x 8.375" H.	COFFEE POT
AC-46207	12 OZ. x 3" H.	TEA POT
AC-46208	9 OZ. x 3.75" H.	CREAMER WITHOUT COVER
AC-46209	9 OZ. x 3.75" H.	CREAMER WITH COVER
AC-46210	8.5 OZ. x 2.25" H.	SUGAR BOWL COVERED
WP-46204	2.3 QT. x 7.875" H.	WATER PITCHER
WP-46206	2.3 QT. x 7.875" H.	WATER PITCHER W/ ICE GUARD

**MILAN COLLECTION**



MILAN COLLECTION (18/8 STAINLESS)  
THE ELEGANT SHAPE ADDS A BEAUTIFUL TOUCH TO ANY TABLETOP.

ACSS-6130	4 OZ., 2 3/8" x 4 1/4"	MILK POT
ACSS-6131	8 OZ., 2 3/8" x 5 1/4"	MILK POT
ACSS-6132	12 OZ., 3 7/8" x 4 1/4"	MILK/TEA POT
ACSS-6133	64 OZ., 3 7/8" x 11 1/2"	WATER PITCHER
ACSS-6134	16 OZ., 2 3/8" x 7 1/4"	COFFEE POT
ACSS-6135	32 OZ., 3 7/8" x 7 3/4"	COFFEE POT
ACSS-6136	48 OZ., 3 7/8" x 9"	COFFEE POT
ACSS-6137	64 OZ., 3 7/8" x 11 1/2"	COFFEE POT
ACSS-6138	4 1/4" x 2 1/8" x 2 1/2"	SUGAR PACKET HOLDER

**EMPIRE COLLECTION**



EMPIRE COLLECTION (18/8 STAINLESS)  
DOUBLE WALL INSULATION KEEPS CONTENTS AT THEIR OPTIMAL SERVING TEMPERATURES FOR HOURS. PERFECT FOR HOTELS!

ACSS-6140	5 OZ.	2 1/2" x 4"	MILK POT.
ACSS-6141	9 OZ.	2 5/8" x 5 1/2"	MILK POT
ACSS-6142	16 OZ.	3 3/4" x 5 3/4"	COFFEE POT
ACSS-6143	32 OZ.	3 3/4" x 8 1/2"	COFFEE POT
ACSS-6144	48 OZ.	4 5/8" x 9 1/2"	COFFEE POT
ACSS-6145	64 OZ.	4 1/8" x 11 1/2"	COFFEE POT
ACSS-6146	64 OZ.	4 1/8" x 9 1/4"	WATER PITCHER W/ICE GUARD

**CADENZA™ MONTE CARLO**



BEVERAGE SERVING COLLECTION (18/10 STAINLESS)

ACSS-6970	5 OZ.	CREAMER
ACSS-6971	64 OZ.	COFFEE SERVER
ACSS-6972	10 OZ.	TEA POT
ACSS-6973	64 OZ.	WATER PITCHER

**ORION™ COLLECTION**



SERVING PIECES (STAINLESS STEEL) HAS A MIRROR-FINISHED EXTERIOR AND A SATIN FINISHED INTERIOR. **VOLLRATH®**

ACSS-104	12 OZ., 4 1/2" H.	COFFEE POT
ACSS-105	20 OZ., 5 1/8" H.	COFFEE POT
ACSS-106	34 OZ., 5 7/8" H.	COFFEE POT
ACSS-107	68 OZ., 7 11/16" H.	COFFEE POT
ACSS-108	12 OZ., 3 3/8" H.	SUGAR BOWL
ACSS-109	12 OZ., 4 1/2" H.	COVERED CREAMER
ACSS-110	8 OZ., 3 1/2" H.	OPEN CREAMER
WPSS-111	68 OZ., 6 3/4" H.	WATER PITCHER

**SANT' ANDREA®, OPERA™**

BEVERAGE SERVERS, SANT' ANDREA®, OPERA™ (SILVERPLATE)

FEATURES A TRADITIONAL OVAL SHAPE AND SUBTLE CURVES WHICH DEFINE THE OPERA COLLECTION. IT IS DURABLE AND TIMELESS WITH SEAMLESS TIPS AND EDGES.

ACSP-60662	64 OZ.	COFFEE POT WITH HINGED LID
ACSP-64802	10 OZ.	TEAPOT WITH HINGED LID
ACSP-64822	20 OZ.	TEAPOT WITH HINGED LID
ACSP-65732	64 OZ.	PITCHER WITH ICE GUARD



**BEVERAGE SERVERS, CREAMERS, & SUGAR BOWLS**



**VENUS BEVERAGE SERVERS (18/10 STAINLESS)**  
18/10 STAINLESS IN MIRROR FINISH. THESE ITEMS ARE ARGON WELDED FOR HEAVY HOTEL BANQUET USE.

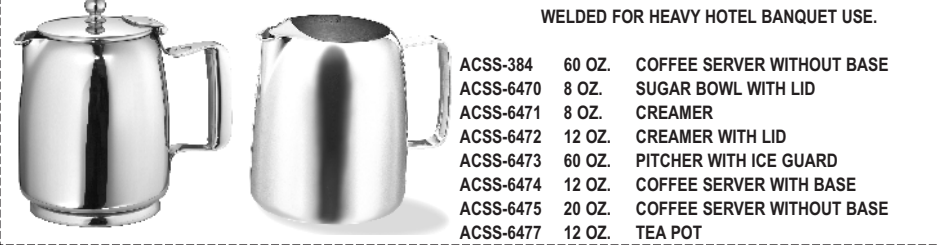

- ACSS-384 60 OZ. COFFEE SERVER WITHOUT BASE
- ACSS-6470 8 OZ. SUGAR BOWL WITH LID
- ACSS-6471 8 OZ. CREAMER
- ACSS-6472 12 OZ. CREAMER WITH LID
- ACSS-6473 60 OZ. PITCHER WITH ICE GUARD
- ACSS-6474 12 OZ. COFFEE SERVER WITH BASE
- ACSS-6475 20 OZ. COFFEE SERVER WITHOUT BASE
- ACSS-6477 12 OZ. TEA POT

**ELITE HAMMERED DOUBLE WALL SERVING SET**  
EACH ITEM IS DOUBLE WALLED STAINLESS STEEL AND INDIVIDUALLY HAMMERED WITH BALL PEEN HAMMER.

CPSS-600	16 OZ.	COFFEE POT
CPSS-601	64 OZ.	COFFEE POT
CRSS-602	5 OZ.	CREAMER
SBSS-603	5 OZ.	SUGAR BOWL WITH /LID
WPSS-604	64 OZ.	WATER PITCHER



**SATURN SERVERS (18/8 STAINLESS)**  
HIGH POLISH FINISH.

- ACSS-521 8 OZ. SUGAR BOWL WITHOUT LID
- ACSS-523 SUGAR BOWL LID ONLY
- ACSS-524 8 OZ. CREAMER
- ACSS-526 8 OZ. SUGAR BOWL WITH LID
- ACSS-527 12 OZ. COVER SERVER
- ACSS-528 12 OZ. CREAMER
- TE-9231 12 OZ. COFFEE POT WITH ARGON WELD HANDLE
- TE-9232 21 OZ. COFFEE POT WITH ARGON WELD HANDLE
- TE-9235 70 OZ. COFFEE POT WITH ARGON WELD HANDLE
- TE-9236 12 OZ. TEAPOT WITH ARGON WELD HANDLE
- TE-9237 21 OZ. TEAPOT WITH ARGON WELD HANDLE
- WP-218 70 OZ. WATER PITCHER WITHOUT ICE GUARD
- WP-218G 70 OZ. WATER PITCHER WITH ICE GUARD

**COFFEE/TEA POURERS (SILVERPLATE)**  
TE-1455 48 OZ.



**IRONSTONE BEVERAGE COLLECTION**  
THE IRONSTONE BEVERAGE COLLECTION IS DOUBLE WALLED TO KEEP THE BEVERAGE WARMER OR COLDER FOR LONGER PERIODS OF TIME. IF THE ITEMS ARE FILLED WITH THE ICE OR COLD BEVERAGES, IT WILL NOT SWEAT. THE HAMMERED FINISH HIDES FINGERPRINTS AS WELL. THE COVERS OPEN TO AN 180 DEGREES FOR SAFETY IN THE WASHING PROCESS.

- BS-5100 IRONSTONE BAIN MARIE
- BS-5101 64 OZ DOUBLE WALLED WATER PITCHER
- BS-5102 64 OZ DOUBLE WALLED WATER PITCHER W/ICE GUARD
- BS-5103 16 OZ DOUBLE WALLED BEVERAGE SERVER
- BS-5104 30 OZ DOUBLE WALLED BEVERAGE SERVER
- BS-5105 60 OZ DOUBLE WALLED BEVERAGE SERVER
- BS-5106 5 OZ DOUBLE WALLED MILK POT
- BS-5107 5 OZ DOUBLE WALLED SUGAR POT (WITHOUT LID)
- BS-5108 LID ONLY FOR SUGAR POT

**4 PC. COFFEE SET (SILVERPLATE)**  
FOOTED COFFEE SET COMES WITH A SUGAR BOWL AND LID, CREAMER, AND COFFEE POT ON A 12" TRAY.  
TE-443

**SUGAR/CREAMER SET**  
STAINLESS STEEL WITH CHROME PLATED LID. DISHWASHER SAFE.  
ACSS-450 8.5 OZ., 5" L., 3.5" W., 4.75" H.

**CREAMERS (STAINLESS)**  
5 OZ., 2" DIA. X 2 3/4" H.  
SOLD IN CASE PACK OF 1 DOZEN.  
AC-14243 SATIN FINISH  
AC-14244 HAMMERED FINISH

**HAMMERED BELL SHAPED CREAMERS (STAINLESS)**  
ACSS-711 3 OZ., 2" H.  
ACSS-712 5 OZ., 2.75" H.  
ACSS-713 8 OZ., 3" H.

**TEAPOT (SILVERPLATE)**  
SPUN BASE.  
TE-3902 8 CUP

**SUGAR & CREAMER POT SET (STAINLESS)**  
TE-4500  
SUGAR: 3" H.  
CREAMER: 2.5" H.

**BELL CREAMERS (STAINLESS)**  
AC-4660 3 OZ.  
AC-4661 5 OZ.  
AC-4662 8 OZ.  
AC-4663 10 OZ.



**SWING BOTTLES (GLASS)**  
THESE SWING BOTTLES COME IN A VARIETY OF SIZES SO THEY CAN BE USED FOR MANY PURPOSES. EACH COMES COMPLETE WITH THE ATTACHED CAP. SOLD IN THE CASE PACKS LISTED.

- |          |                     |                      | CASE PACK |
|----------|---------------------|----------------------|-----------|
| BTL-2520 | CORIAL SWING BOTTLE | 33 3/4 OZ., 12" H.   | 20 EACH   |
| BTL-2521 | SWING BOTTLE        | 17 OZ., 9 1/2" H.    | 6 EACH    |
| BTL-2522 | SQUARE SWING BOTTLE | 8 1/2 OZ., 7 1/2" H. | 28 EACH   |
| BTL-2523 | MINI SWING BOTTLE   | 2 1/2 OZ., 4" H.     | 1 DOZ.    |
| BTL-2524 | CORIAL SWING BOTTLE | 38 OZ., 9" H.        | 1 DOZ.    |
| BTL-2525 | CORIAL SWING BOTTLE | 19 OZ., 5" H.        | 1 DOZ.    |

**CREAMER AND SUGAR BOWL SET (SILVERPLATE)**  
THIS ELEGANT 2-PIECE SET OFFERS A SUGAR BOWL WITH LID AND A MATCHING CREAMER.  
TE-90513

# WATER PITCHERS



### WATER PITCHER (STAINLESS)

BELL SHAPED WATER PITCHERS WITH HOLLOW TUBULAR HANDLES.

- AC-17023 3 QT. (96 OZ) WITHOUT ICE GUARD
- WP-9270 2 QT. (64 OZ) WITHOUT ICE GUARD
- WP-2205 2.25 QT. (64 OZ.) WITH ICE GUARD
- WP-2206 3 QT. (96 OZ.) WITH ICE GUARD



### WATER PITCHER (18/8 STAINLESS)

MIRROR FINISH ICE GUARD, WELDED HOLLOW TUBULAR HANDLE.

- WP-161 2 QT. (64 OZ.) 9 1/8" H.



### WATER PITCHERS (STAINLESS) HAMMERED.

- WP-72606 48 OZ. (1.5 QT.)
- WPSS-8200 72 OZ. (2.25 QT.)



### WATER PITCHERS (STAINLESS)

BELL SHAPE, HAMMERED STAINLESS STEEL. NO ICE GUARD. USE TO SERVE WATER, JUICE, ICED TEA, SODA AND MORE.

- WP-85 68 OZ. (2 QT.) 8.5" L. x 5.25" W. x 8" H.
- WP-97 100 OZ. (3 QT.) 9.25" L. x 6" W. x 8" H.



### WATER PITCHER (STAINLESS)

HIGH POLISHED. ICE GUARD.

- WPSS-21 2 QT. (64 OZ.)



### WATER PITCHERS (18/10 STAINLESS)

THIS CONTEMPORARY COLLECTION IS CRAFTED WITH AN ANGULAR STYLE AND A BRUSH FINISH. 64 OZ CAPACITY.

- ACSS-88631 WITHOUT ICE GUARD
- ACSS-88731 WITH ICE GUARD



### WATER PITCHER (STAINLESS)

LINES WATER PITCHER, DOUBLE WALL STAINLESS STEEL.

- WC-72709 52 OZ. (1.5 QT.)



### WATER PITCHER WITH ICE GUARD (STAINLESS STEEL)

DURABLE AND TIMELESS WITH SEAMLESS TIPS AND EDGES.

- ACSS-65731 64 OZ.



### WATER PITCHER (18/8 STAINLESS)

ICE GUARD, HOLLOW HANDLE.

- WP-1921 2 QT. 7.25" HT.



### WATER PITCHER WITH ICE GUARD (18/8 STAINLESS)

HIGH POLISHED. SOLD CASE PACK OF 6. SEE MORE COLLECTION PAGE ?.

- ACSS-811 68 OZ.



### WATER PITCHER (STAINLESS)

WATER PITCHER W/ICE GUARD.

- WP-4645 2 QT. (64 OZ.)



### WATER PITCHERS (STAINLESS)

SEAMLESS CONSTRUCTION AND SATIN FINISHED BELL SHAPED, ALL WELDED HANDLES, HOLLOW HANDLE STAYS COOL.

- WP-7890 2 1/8 QT. (64 OZ.) 8" H.
- WP-7891 3 1/8 QT. (96 OZ.) 9" H.
- WP-7892 4 1/8 QT. (128 OZ.) 10.375" H.



### WATER PITCHERS (18/8 STAINLESS)

THE UNIQUE TRIANGULAR BODY DESIGN ELEVATES THE OVERALL APPEARANCE OF ANY ESTABLISHMENT. PLEASE SPECIFY MIRROR(M) FINISH OR SATIN(S) FINISH UPON ORDERING.

- WP-46204 2.3 QT. WITHOUT ICE GUARD
- WP-46206 2.3 QT. WITH ICE GUARD

CASE PACK

- 1 EACH
- 4 EACH



### WATER PITCHER (18/8 STAINLESS)

MIRROR-FINISHED EXTERIOR AND A SATIN FINISHED INTERIOR. SOLD IN CASE PACKS OF 6 EACH.

- WPSS-111 68 OZ., 6.75" H.

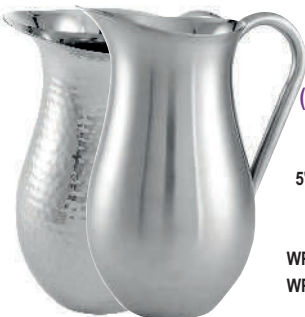

### DOUBLE WALL WATER PITCHERS (STAINLESS STEEL)

64 OZ. CAPACITY 5" DIA. X 11" H., 8 3/4" DIA. WITH HANDLE.

- WPSS-6400 SATIN FINISH
- WPSS-6401 HAMMERED



### GEOMETRIC WATER PITCHER (STAINLESS STEEL WITH GOLD HANDLES)

THE GEOMETRIC DESIGN WILL ONLY ENHANCE YOUR TABLETOP OR EVENT. 4.5" DIA. X 10" H. (5.75" DIA WITH HANDLE)

- WP-70223 56 OZ.



### WATER PITCHER (18/8 STAINLESS)

THE ELEGANT SHAPE ADDS A BEAUTIFUL TOUCH TO ANY TABLETOP.

- ACSS-6133 64 OZ., 3 7/8" x 11 1/2"



### WATER PITCHER WITH ICE GUARD (18/8 STAINLESS)

DOUBLE WALL INSULATION KEEPS CONTENTS AT THEIR OPTIMAL SERVING TEMPERATURES FOR HOURS.

- ACSS-6146 64 OZ.



### HAMMERED BELL PITCHERS

THESE BELL PITCHERS HAVE A HAMMERED DESIGN WITH A MIRROR FINISH.

- WPH-500 2 QT. WITHOUT ICE GUARD
- WPH-501 2 QT. WITH ICE GUARD
- WPH-502 3 QT. WITHOUT ICE GUARD
- WPH-503 3 QT. WITH ICE GUARD



### DOUBLE WALL PITCHER WITH LID (STAINLESS STEEL)

- WPSS-4800 52 OZ. 6" DIA. X 9" H.



### WATER PITCHER (18/10 STAINLESS)

WITH ICE GUARD HIGH POLISH FINISH. SOLD IN CASE PACKS OF 3.

- ACSS-6473 60 OZ.



### WATER PITCHER (ALUMINUM)

SATIN FINISH, RIVETED HANDLE, WITH ICE GUARD.

- WP-68174 2 1/8 QT. (64 OZ.) 7.8" H.



### WATER PITCHER WITH ICE GUARD (18/8 STAINLESS)

2 QUART WATER PITCHER FEATURES AN ICE GUARD THAT REDUCES SPLASHING AND SPILLS FOR TROUBLE-FREE POURING.

- WP-1922 2 QT. (64 OZ.) 9 1/4" H.



### WATER PITCHER (18/10 STAINLESS)

- TE-622 68 OZ. CAPACITY



### HAMMERED DOUBLE WALL WATER PITCHER (STAINLESS)

INDIVIDUALLY HAMMERED WITH BALL PEEN HAMMER.

- WPSS-604 64 OZ. CAPACITY

# WATER PITCHERS, DECANTERS, & CARAFES



### WATER PITCHERS (18/8 STAINLESS)

THIS IS MADE FROM 18/8 STAINLESS STEEL WITH A SATIN FINISH THAT IS EXCELLENT FOR HOTEL OR RESTAURANT USE. ADDS CHARACTER TO ANY TABLE SETTING FOR A VARIETY OF FUNCTIONS OR EVENTS.

WP-218 70 OZ. WITHOUT ICE GUARD  
WP-218G 70 OZ. WITH ICE GUARD



### HAMMERED STRAIGHT WATER PITCHER (STAINLESS)

PTR-950  
60 OZ., 11" H.



### WATER PITCHERS (PLASTIC)

PITCHERS MADE OF HEAVY-DUTY SAN PLASTIC TO PREVENT BREAKAGE! DISHWASHER SAFE. SOLD IN CASE PACKS OF 4.

WP-3200 32 OZ.  
WP-6000 60 OZ.



### WATER PITCHER (POLYCARBONATE)



AC-553607 32 OZ. 7" H.  
AC-553807 1.5 QT. (48 OZ.) 7 2/3" H.  
AC-554007 1.8 QT. (60 OZ.) 8 1/4" H.



### BEER PITCHER (CLEAR POLYCARBONATE)

PERFECT FOR ANY CATERING OR BUFFET APPLICATION.

WP-6500  
60 OZ.



### WATER PITCHER (POLYCARBONATE)

THICK WALLS AND A CLEAR OPTIC BOTTOM, MADE OF BREAK RESISTANT POLYCARBONATE. DISHWASHER SAFE. LIDS SOLD SEPARATELY.

WP-175 58 OZ. (1.8 QT.)  
5.13" TD. x 9.26" H.  
WPC-176 5.25" DIA. x 2" H. LID FOR WP-175



### WATER PITCHERS (POLYCARBONATE)

THESE POLYCARBONATE THREE LIP WATER PITCHERS MAKE POURING EASY.

60 OZ. (1.8 QT.)  
AC-1573 CLEAR  
AC-1575 AMBER



### PITCHER (GLASS)

SOLD IN CASE PACK OF 6 EACH.

AC-2401  
60 OZ. (1.8 QT.)  
9" H., 5 3/4" T.  
4 1/2" B., 7" M.



### WATER PITCHER (PLASTIC)

MADE OF POLYCARBONATE PLASTIC. BUILT-IN ICE CORE KEEPS BEVERAGE COOL WITHOUT DILUTING. SMOOTH BODY, DISHWASHER SAFE.

WP-4500  
2 QT., 10.9" H.



### DISPOSABLE PITCHER (PLASTIC)

HEAVY DUTY PITCHER-CLEAR. SOLD IN CASE PACKS OF 6 ONLY!

DP-560  
60 OZ.



### PITCHER (DISPOSABLE)

HEAVY DUTY PLASTIC, SWIRL DESIGN. SOLD IN CASE PACKS OF 12 ONLY.

DP-4510  
60 OZ.



### BEVERAGE PITCHER WITH POUR LIP (GLASS)

SOLD IN CASE PACK OF 6 EACH.

WP-55239  
44 OZ.  
7 3/4" H., 7" M.  
4 1/4" T., 3 1/4" B.



### ATLANTIS PITCHER (GLASS)

SOLD IN CASE PACK OF 6 EACH.

GL-7563  
73 OZ.  
11 1/8" H., 5 3/4" T.  
3 1/2" B., 7 3/4" D.



### MARIO PITCHER (GLASS)

SOLD IN CASE PACKS OF 6 EACH.

GL-7561  
58.4 OZ.  
8 3/4" H., 4 1/4" T.  
3 1/2" B., 7 1/2" D.



### IMPRESSIONS PITCHER (GLASS)

2.5 QUART CAPACITY, 10 1/8" H., 4 1/2" T., 5 5/8" B., 7 3/8" D., HAND MADE. SOLD AS CASE PACK OF 6 EACH.

GL-7562  
80 OZ.



### BEER PITCHER (GLASS)

SOLD IN CASE PACK OF 6 EACH.

AC-665  
55 OZ. (1.7 QT.)  
7" DIA., 9 1/8" H.



### PITCHERS (GLASS)

GLASS PITCHER HAS AN EASY-POUR SPOUT, SIDE HANDLE AND ANGULAR DESIGN. SOLD IN CASE PACKS OF 6 EACH.

GL-10050 63 OZ.  
GL-10051 27 OZ.



### PITCHER (DISPOSABLE)

HEAVY DUTY PLASTIC, SWIRL DESIGN. SOLD IN CASE PACK OF 50 EACH ONLY.

DP-4500  
50 OZ.

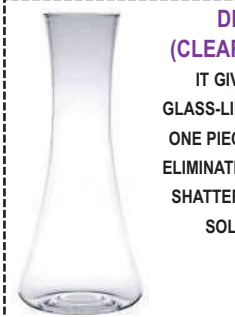

### DECANTER NAPA (CLEAR POLYCARBONATE)

IT GIVES A CRYSTAL CLEAR GLASS-LIKE LOOK. IT IS A COMPLETE ONE PIECE MOLDING PROCESS TO ELIMINATE WEAK JOINTS. THEY ARE SHATTER AND BREAK RESISTANT.

SOLD IN CASE PACKS OF 12 ONLY.

GL-95446 750 ML



### BEVERAGE DECANTERS (POLYCARBONATE)

MADE OF VIRTUALLY UNBREAKABLE POLYCARBONATE TO DELIVER YEARS OF DEPENDABLE SERVICE WITHOUT DENTING OR SCRATCHING. COMES WITH SPILL PROOF LID. SOLD IN CASE PACKS OF 12 EACH.

GLP-1000 33 OZ., 1 LITER 9 3/4" H. DECANTER  
GLP-1002 17 OZ., 1/2 LITER 7 7/8" H. DECANTER  
GLP-1004 LID FOR GLP-1000, GLP-1002 LID



### DECANTERS WITH LID (POLYCARBONATE)

MADE OF EASY TO CLEAN, NON-BREAKABLE POLYCARBONATE MATERIAL.

GLP-1500 17 OZ., 0.5 L.  
GLP-1501 33 OZ., 1 L.  
GLP-1502 50 OZ., 1.5 L.

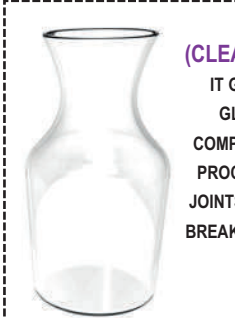

### DECANTER (CLEAR POLYCARBONATE)

IT GIVES A CRYSTAL CLEAR GLASS-LIKE LOOK. IT IS A COMPLETE ONE PIECE MOLDING PROCESS TO ELIMINATE WEAK JOINTS. THEY ARE SHATTER AND BREAK RESISTANT. SOLD IN CASE PACKS OF 12 ONLY.

GL-95481 9 OZ.



### DISPOSABLE CARAFES (POLYPROPYLENE PLASTIC)

THESE DISPOSABLE CARAFES HAVE A CLASSIC THEY ARE DISPOSABLE WHICH MAKES CLEAN UP IS A SNAP! ALL SALES ARE FINAL. SOLD IN CASE PACKS OF 1 DOZEN ONLY!

DP-2700 35 OZ. 10.5" H. CASE PACK 1 DOZEN  
DP-2701 20 OZ. 8.75" H. CASE PACK 1 DOZEN  
DP-2702 7.5 OZ. 10.5" H. CASE PACK 60 EACH



### TEMPO CARAFE (GLASS)

SOLD IN CASE PACKS ONLY!

GL-78502  
10 OZ., 2.5" T., 2.6" M., 6.3" H. CASE PACKS OF 4 DOZ.

GL-78503  
21 OZ., 3.0" T., 3.2" M., 6.3" H. SOLD IN CASE PACKS OF 2 DOZEN



### DECANTER (GLASS)

EACH PIECE IS MADE OF CLEAR GLASS WITH A CLASSIC STYLE AND TRADITIONAL ELEGANCE. EACH ONE WILL MATCH ANY DECOR OR TABLE SETTING, SO THEY ARE PERFECT FOR BARS, RESTAURANTS OR ANY CATERED EVENT. SOLD IN CASE PACKS OF 2 DOZEN.

GL-9946 13 OZ.

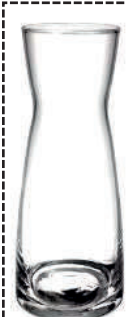

### DECANTER (GLASS)

THIS GLASS DECANTER HAS A SMALL OUNCE CAPACITY, MAKING IT A UNIQUE WAY TO SERVE FRUIT JUICES OR OTHER BRUNCH FAVORITES. PERFECT ADDITION TO ANY BAR OR CATERER! SOLD IN CASE PACKS OF 2 DOZEN.

GL-10052  
7 OZ., 3 1/4" T., 2 1/4" B., 3 1/4" D., 5 1/2" H.



## DECANTERS & CARAFES



### CARAFE (GLASS)

THESE GLASS CARAFE ARE GREAT FOR ANY EVENT THAT NEEDS JUICE, WATER, OR WINE. THE SIMPLE DESIGN IS GREAT TO BE SERVED.

- |         |                                |                  |
|---------|--------------------------------|------------------|
|         |                                | <b>CASE PACK</b> |
| AC-2530 | 8 1/2 OZ, 1/4 LITER            | <b>1 DOZ</b>     |
|         | 7" H. X 2 1/2" T. X 2 3/4" B.  |                  |
| AC-2531 | 17 OZ, 1/2 LITER               | <b>6 EACH</b>    |
|         | 10 1/4"H X 3 3/4" T X 4 1/4" B |                  |
| AC-2532 | 33 1/4 OZ, 1 LITER             | <b>6 EACH</b>    |
|         | 10 1/4"H X 3 3/4" T X 4 1/4" B |                  |



### CARAFE (POLYCARBONATE)

THIS APPEARANCE OF CUT CRYSTAL WITH THE PRACTICALITY OF POLYCARBONATE. IT IS PERFECT FOR INDOOR AND OUTDOOR EVENTS. SOLD IN THE CASE PACKS OF 6 EACH.

GL-02014  
1 LITER CARAFE



### DECANTER (LEAD-FREE CRYSTAL)

SOLD IN CASE OF 2 DOZEN.  
GL-11011  
15 OZ., 1/2 LITER

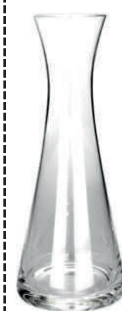

### DECANTER (LEAD-FREE CRYSTAL)

SOLD IN CASE OF 2 DOZEN.  
GL-11012  
1/4 LITER, 8 OZ.



### CARAFES (POLYCARBONATE)

TRADITIONAL CARAFE IS MADE FROM CLEAR POLYCARBONATE. IT GIVES A CRYSTAL CLEAR GLASS-LIKE LOOK. IT IS A COMPLETE ONE PIECE MOLDING PROCESS TO ELIMINATE WEAK JOINTS. THEY ARE SHATTER AND BREAK RESISTANT. THE ITEM IS PRICED BY THE EACH, BUT MUST BE PURCHASED IN THE QUANTITIES 12 EACH.

- |          |                          |
|----------|--------------------------|
| GL-95445 | 17 OZ., 0.5 LITER CARAFE |
| GL-95447 | 34 OZ., 1 LITER CARAFE   |
| GL-95474 | SNAP LID, POLYPROPYLENE  |



### CARAFE (PLASTIC)

THIS DISPOSABLE CARAFE IS GREAT FOR ANY EVENT THAT NEEDS JUICE OR WINE. THE SIMPLE DESIGN IS GREAT TO BE SERVED AT THE TABLE OR BY A SERVER. SOLD IN CASE PACKS OF 12 ONLY.

DP-4520 35 OZ.



### COFFEE DECANTER (STAINLESS STEEL BASE, POLYCARBONATE PLASTIC CONTAINER, HANDLE & CORE)

THIS 64 OUNCE DECAF COFFEE DECANTER IS EXTREMELY DURABLE AND RESISTANT TO BREAKAGE, PERFECT FOR HEAVY DUTY USAGE!

- |          |                        |
|----------|------------------------|
| AC-8890  | 64 OZ, 1.9 LITER       |
| AC-88891 | 64 OZ, 1.9 LITER DECAF |

## CHAFERS & CHAFER STORAGE BOXES



### CHAFER STORAGE BOX (POLYPROPYLENE)

THIS CHAFER STORAGE BOX IS IMPACT-RESISTANT AND FEATURES INTEGRATED HANDLES.

BX-2515 25" x 15" x 12", COLOR: GRAY



**X-LARGE SIZE!**

### X-LARGE STACK BOX WITH HINGE

MADE OF HEAVY-DUTY IMPACT RESISTANT PLASTIC CONSTRUCTION WITH INTEGRAL HANDLES.

COLOR: GRAY

BX-311 INSIDE TOP: 28 3/4" x 20 3/4" x 18 3/4"  
INSIDE BOTTOM: 26 5/8" x 18 5/8"



### SMALL STACK BOX WITH HINGED LID

MADE OF HEAVY-DUTY IMPACT RESISTANT PLASTIC CONSTRUCTION WITH INTEGRAL HANDLES.

BX-310 INSIDE TOP: 20 1/8" x 11 3/8" x 12 3/8"  
INSIDE BOTTOM: 18 7/8" x 10 1/8"



### CHAFER STORAGE CONTAINER

RECTANGULAR CHAFING DISH CONTAINER WITH ATTACHED LID. INNER DIMENSIONS ARE

BX-400 29.9" L. X 20.375" W. X 18.1" H.



### MEDIUM STACK BOX WITH HINGED LID

HOLDS ROUND CHAFERS, COFFEE URNS, OR SOUP CHAFERS. CHAFER BOX COMES WITH REMOVABLE LID AND FOAM BASE.

COLOR: GRAY.

BX-312 INSIDE TOP: 21 3/4" x 20 7/8" x 13"  
INSIDE BOTTOM: 21 7/16" x 20 1/2"



### CHAFER STORAGE CONTAINER & SPECIALTY DOLLY

ROUND CHAFING DISH CONTAINER. INNER DIMENSIONS ARE 21.375" L. X 20.375" W. X 13.75" H.

LID AND TRANSPORT DOLLY SOLD SEPARATELY.

- |         |                              |
|---------|------------------------------|
| BX-401  | ROUND CHAFING DISH CONTAINER |
| BXD-401 | SPECIALTY DOLLY FOR BX-401   |



### COLLAPSIBLE RECTANGULAR CHAFERS

THE TWO HINGES ALLOW FOR FLAT STORAGE AND TRANSPORT AND THE WIDGUARD CLIPS INTO HOLES ON EITHER END TO ENSURE THE CHAFER STAYS IN ITS RECTANGULAR DESIGN.

USE WITH ANY CANNED HEAT.

- |          |   |
|----------|---|
| CHF-3640 | STAINLESS STEEL, 8 QT., 21" W. X 13" D. X 11.25" H. |
| CHF-3640 | BRONZE, 8 QT., 21" W. X 13" D. X 11.25" H.          |



### MADERA CHAFER WITH RECLAIMED WOOD & METAL

IT IS PAIRED WITH A STAINLESS STEEL LIFT TOP CHAFER LID WHICH KEEPS FOOD HOT AND FRESH UNTIL SERVING TIME. FEATURES EASY ACCESS DRAWER THAT PULLS OUT TO PLACE FUEL. INCLUDES PAN AND STAINLESS COVER.

CHW-3420 23" W. X 14.5" D. X 13.5" H.

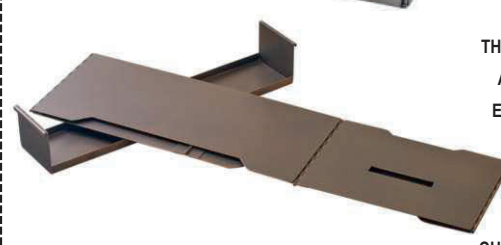

### ASHWOOD RECTANGULAR ROLL TOP CHAFER

THE GRAY WASHED OAK AND POLISHED STAINLESS STEEL CHAFER HAS AN EASY ACCESS DRAWER FOR THE CHAFER FUEL AND A BUILT IN WINDGUARD TO PROTECT FROM THE FLAME. INCLUDES STAINLESS STEEL CHAFER COVER.

CHW-3800 8 QT., 22" W. X 14" D. X 13.5" H.



## CHAFERS



**TWO TONE CHAFERS (STAINLESS STEEL)**  
THESE TWO TONE CHAFER ARE POLISHED STAINLESS WELD CONSTRUCTION WITH GOLDPLATED LEGS, HANDLES, AND FINIAL. SOLD COMPLETE!

- CHSS-791 6 QT. OVAL CHAFER, 22.5" D. x 13" W. x 11" H.
- CHSS-7911 FOOD PAN FOR CHSS-791
- CHSS-793 8 QT. RECT. CHAFER, 24" D. x 13.9" W. x 9.5" H.
- STP-4501 WATER PAN FOR CHSS-795
- CHSS-795 4 QT. ROUND CHAFER
- CHSS-7951 FOOD PAN FOR CHSS-795
- CHSS-796 4 QT. RECT. CHAFER, 17" D. x 12" W. x 10.5" H.



**MALIBU CHAFERS (STAINLESS STEEL)**

CHAFERS ARE MADE OF STAINLESS STEEL WITH GOLD ACCENTS ON THE LEGS AND HANDLES. THE COVER LIFTS OFF AND CLIPS ONTO THE FRAME. SOLD COMPLETE!

- CH-201 8 QT. OBLONG 25.1" L. x 14.3" W. x 9.8" H.
- CH-202 6 QT. OVAL 21.5" L. x 12.9" W. x 9.5" H.
- CH-203 4 QT. ROUND 14.2" L. x 14.1" W. x 9.5" H.
- FP-203 FOOD PAN FOR CH-203



**ADAGIO ROLL TOP CHAFERS (STAINLESS STEEL WITH GOLD HANDLE)**  
CHAFER SOLD COMPLETE!

- CHSS-4440 8 QT. RECTANGULAR CHAFER, 26.5" x 19.5" W. x 17.5" H.
- CHSS-4443 7 QT. ROUND CHAFER, 18" L. X 18 1/2" W. X 18" H.
- FP-798 ROUND FOOD PAN FITS CHSS-4443
- WP-798 ROUND WOOD PAN FITS CHSS-4443



**FUEL CUP & LID UNIT (STAINLESS)**

FITS STANDARD SIZE CHAFERS.  
ACSS-777 STAINLESS  
PT-260 SILVERPLATE  
PT-642A SILVERPLATE, SMALL SIZE



**MADISON MAROLL TOP CHAFERS (STAINLESS STEEL)**  
CHAFER SOLD COMPLETE!

- CHSS-4441 8 QT. RECTANGULAR CHAFER, 30" L. x 29" W. x 14" H.
- CHSS-4442 8 QT. OVAL CHAFER
- CHSS-4445 6 QT. ROUND CHAFER, 22" L. x 20" W. x 14" H.
- CHSS-7941 ROUND FOOD PAN FIT CHSS-4445
- CHSS-7941WP ROUND FOOD PAN FIT CHSS-4445
- STP-45595 18/8 STAINLESS RECTANGULAR DIVIDED FOOD PAN FITS FULL SIZE CHAFER, 20.88" L. X 12.81" W. X 2.5" H.
- STP-45596 ROUND DIVIDED FOOD PAN FITS CHSS-4445



**ROYALTY CHAFERS (STAINLESS)**

THESE STAINLESS CHAFERS FEATURE DEFINED SCULPTURED LEGS, HANDLES, AND KNOBS. ORNATE DESIGN. SOLD COMPLETE.

- CH-5450 8 QT. RECTANGULAR CHAFER, 26.9" L. x 14.6" W. x 12.6" H.
- CH-9151 WATER PAN 4.5" FOR CH-5450
- STP-4501 FOOD PAN 2.5" FOR CH-5450
- CH-5451 4 QT. RECTANGULAR CHAFER, 17.9" L. x 11.4" W. x 12.0" H.
- CH-5460 6 QT. ROUND CHAFER, 15.8" L. x 15.6" W. x 12" L.
- FP-5461 FOOD PAN FOR CH-5460



**WICK HEATING FUEL**

- |          |         |  |        |
|----------|---------|--|--------|
| FUL-6386 | 9.5 OZ. | STANDARD: 6 HR., HIGH: 3 HR., LOW: 8 HR. | SET/6  |
| FUL-638  | 9.5 OZ. | STANDARD: 6 HR., HIGH: 3 HR., LOW: 8 HR. | SET/24 |
| FUL-425  | 6.5 OZ. | STANDARD: 4 HR., HIGH: 2 HR., LOW: 5 HR. | SET/24 |
| FUL-213  | 3.5 OZ. | STANDARD: 2 HR., HIGH: 1 HR., LOW: 3 HR. | SET/48 |

**CASE PACK**



**UNIVERSAL ELECTRIC CHAFER HEATER**

SIZED TO FIT STANDARD FUEL CUP OPENINGS. SPRING-LOADED ELEMENT MAINTAINS FULL CONTACT WITH THE WATER PAN FOR EFFICIENT HEAT DISTRIBUTION. EACH UNIT COMES WITH AN INTERNAL AUTOMATIC RESETTING THERMOSTAT TO PREVENT OVER HEATING AND A SIX FOOT LONG GROUNDED CORD. UL APPROVED.

- CH-7301 120 VOLTAGE, 160/275 WATTS., 2.3 AMP

# CHAFERS



**GRANDEUR CHAFERS  
(18/10 STAINLESS)**

18/10 STAINLESS STEEL CHAFER WITH FASHIONABLE STRAP STYLE LEGS; COVER OPENS TO 180 DEGREES; FEATURES FULL SIZE FOOD PANS, 2.5" OR 3" DEEP! SOLD COMPLETE.

- CH-17019 8 QT. RECT. GOLD ACCENTS
- CH-17020 8 QT. RECT. ALL STAINLESS



**MINI SAUCE CHAFERS  
WITH COVER  
(STAINLESS)**

CHSS-3524 8" DIA., 23 OZ.

**ONEIDA**



**CHAFERS  
(MIRROR FINISH STAINLESS)**

ROLL-TOP COVER CAN BE OPENED TO VARIOUS POSITIONS UP TO 180 DEGREES. INCLUDES FOOD PAN, WATER PAN AND FUEL HOLDERS. EXTRA HEAVYWEIGHT. 6 QT. SIZE: 21.1" L. x 21.3" W. x 14" H. 8 QT. SIZE: 28.9" L. x 19.6" W. x 18.4" H.

- CHSS-1200 8 QT. OBLONG, ALL STAINLESS
- CHSS-1201 6 QT. ROUND, ALL STAINLESS
- CHSG-1200 8 QT. OBLONG, GOLD ACCENT
- CHSG-1201 6 QT. ROUND, GOLD ACCENT



**CHAFERS (STAINLESS)**

STAINLESS STEEL CONSTRUCTION WITH MIRROR FINISH, BRASS HANDLES, STACKABLE WELDED FRAMING.

- CH-8533 8 QT. RECTANGULAR 11" H. x 23 3/4" W. x 13 1/4" D.
- CH-8633 5 QT. ROUND 17" H. x 13" DIA.

**ROLLTOP CHAFERS (STAINLESS STEEL)**

STAINLESS ROLLTOP CHAFERS. GOLDPLATE LEGS, FINIAL AND HANDLES. HEAVY WEIGHT.

- CHSS-9570 8 QT. RECT. 25.5" L. x 19" W. x 16.6" H.
- CHSS-9572 6 QT. ROUND 19.5" L. x 20.8" W. x 16.3" H.

**SATELLITE CHAFERS (18/10 STAINLESS)**

18/10 STAINLESS STEEL CHAFER WITH FASHIONABLE STRAP STYLE LEGS; COVER OPENS TO 180 DEGREES; FEATURES FULL SIZE FOOD PANS, 2.5" OR 3" DEEP! SOLD COMPLETE.

- CH-17022 6 QT. ROUND, ALL STAINLESS
- CH-17024 6 QT. ROUND, GOLD ACCENTS

**LUNAR CHAFERS**

THE LUNAR CHAFERS ARE AN 8 QUART ELEGANT STYLED CHAFER WITH TWO OPTIONS FOR THE COVER, MIRROR FINISHED STAINLESS OR HAMMERED STAINLESS. THEY ARE A SIMPLE FUNCTION TO OPEN TO 90 DEGREES.

- CH-8870 8 QT LUNAR CHAFER WITH MIRROR FINISH LID
- CH-8871 8 QT LUNAR CHAFER WITH MIRROR HAMMERED LID
- CH-8872 MIRROR FINISH LID FOR LUNAR CHAFER
- CH-8873 HAMMERED FINISH LID FOR LUNAR CHAFER
- CH-8874 WATER PAN FOR 8 QT LUNAR CHAFER



**ROLLTOP CHAFER WITH GOLD ACCENT  
(STAINLESS STAINLESS)**

OBLONG HALF ROLLTOP, FULL SIZE, 8 QT. HEAVY WEIGHT, GOLD ACCENTS. COMES COMPLETE WITH STANDARD WATER PAN, FOOD PAN, AND TWO FUEL HOLDERS. SOLD COMPLETE.

- CHSS-5080 8 QT. CHAFER, 25" L. x 14.5" W. x 15.9" H.
- CHSS-7993 ROLLTOP COVER, 22.8" L. x 14" W. x 6.6" H.



**ONEIDA**

**HALF ROLLTOP CHAFERS  
(18/10 STAINLESS)**

- 90° ROLLTOP ROUND CHAFER. NOBLESSE STYLE. CH-2057 4 QT., 13" DIA.



**SOMERVILLE® ROUND  
ROLL TOP CHAFER (STAINLESS)**

- STAINLESS STEEL WITH A MIRROR FINISH. CH-4635610 6 QT., 19 5/8" X 20" X 19 5/8"



**GRANDEUR CHAFER  
(18/8 STAINLESS WITH GOLD ACCENTS)**

ITS STYLISH 18/8 STAINLESS STEEL FINISH WITH GOLD ACCENT DESIGN IS IDEAL FOR WEDDINGS, BUFFETS, OR ANY CATERING EVENT. IT CAN HOLD UP TO 8 QUARTS OF FOOD. THE CHAFER IS SOLD COMPLETE WITH A FOOD PAN, WATER PAN, FUEL HOLDERS, AND A COVER. THE BASE IS WELDED FOR EXTRA STRENGTH.

- CHG-700 8 QT., 25.2" L. X 14.4" W. X 10.9" H.

# CHAFERS



**PANACEA™ CHAFERS WITH 24K GOLD ACCENTS (STAINLESS STEEL)**

THESE CHAFERS ARE MADE OF MIRROR FINISHED STAINLESS STEEL. THE 24K GOLD ACCENTS ADD TO THE CONTEMPORARY STYLING OF THESE CHAFERS, DURABLE, STYLISH, AND LOW MAINTENANCE.

**RECTANGULAR CHAFER**

- CHSS-270 4 QT., 16 5/8" L. X 11 5/8" W. X 12 3/4" H. RECTANGULAR CHAFER
- CHSS-271 9 QT., 24" L. X 17" W. X 13 1/2" H., RECTANGULAR CHAFER

**ROUND CHAFER**

- CHSS-272 4 QT., 16" L. X 15" W. X 11.5" HT., ROUND CHAFER
- CHSS-274 6 QT., 18" DIA. X 13" HT., ROUND CHAFER
- CHSS-4523 4.2 QT. ROUND FOOD PAN
- CHSS-4524 4.2 QT. DIVIDED ROUND FOOD PAN

**SOUP MARMITE**

- CHSS-273 7.4 QT., 11.5" DIA. X 15.5" HT., SOUP MARMITE
- CHSS-275 4.2 QT., 11.5" DIA., X 15.5" HT., SOUP MARMITE



**CHAMPION SERIES™ ROUND CHAFER (18/10 STAINLESS STEEL)**

NEW CHAMPION SERIES CHAFERS FEATURE A GLASS COVER, STAINLESS STEEL CHAFING STAND AND A PORCELAIN INSERT HEATING OPTIONS: CANNED FUEL OR ELECTRIC

- CHSS-53320 6 QT. CHAFER
- FP-53320 STAINLESS STEEL FOOD PAN
- CHI-53320 PORCELAIN FOOD PAN



**ELECTRIC WATER PAN**

THIS WATER PAN FEATURES BUILT-IN FEET, ALLOWING THEM TO BE USED WITH OR WITHOUT A STAND. IT HOLDS ONE FULL SIZE PAN OR TWO HALF SIZE PANS. POWER CONSUMPTION IS 900 WATTS, UL LISTED, THERMOSTATICALLY CONTROLLED.

CHAFER STAND SOLD SEPARATELY.

- CH-2005 23.13" L. X 14.63" W. X 8.5" H.



**ELITE SERIES CHAFERS (STAINLESS)**

STAINLESS STEEL CHAFERS WITH ROMAN LEGS, CHROME TRIM, AND HAMMERED FINISH. DRIPLESS WATER PAN AND COVER, WINDGUARD, FULL ROLL AND HALF LOCKING COVER, SLOW DOWN LOCK MECHANISM. LIFETIME WARRANTY.

- CHH-5000 4 QT., 20.25" X 19.25" X 18.75"
- CHH-5001 4 QT., 24.75" X 17" X 17.75"
- FP-5000 1/2 SIZE

- ROUND CHAFER
- RECTANGULAR CHAFER
- ROUND FOOD PAN



**CLASSIC BRASS TRIM ELECTRIC CHAFERS**

18/8 MIRROR FINISH STAINLESS STEEL WITH BRASS TRIM. FULLY ADJUSTABLE NON-THERMOSTATIC HEAT CONTROL, SIX FOOT GROUNDED PLUG, 120V, 700W, 6 AMP, AC ONLY. WATER PAN IS WELDED TO UNITIZED FRAME, FRAME AND CONTROL ARE NON-IMMERSIBLE. CAN BE USED WITH FUEL OR ELECTRIC.

- CHSS-46040 LONG SIDE RECEPTACLE 25.25" X 18.25" X 15"
- CHSS-46045 SHORT SIDE RECEPTACLE 21.25" X 14.25" X 15"



**COOL TOUCH STACKABLE CHAFERS (STAINLESS STEEL)**

FEATURE MATTE FINISH EMBOSSED LEGS FOR STRENGTH AND STYLE.

- CH-9860 8 QT. CHAFER 25 5/8" X 14 5/16" X 13 9/16"
- CH-9870 4 QT. CHAFER 18 1/16" X 12 1/16" X 12 7/32"
- AC-9861 STACKABLE STAND 25 5/8" X 14 5/16" X 9 1/4" FITS CH-9860 ONLY



**DISPOSABLE FOIL PAN AND FOIL LID**  
SOLD IN CASE PACKS ONLY!

- |        |   |                              |          |
|--------|---|------------------------------|----------|
| DP-150 | FULL SIZE FOIL LID                      | 20 13/16" x 12 7/8" x 5/8"   | 50 EACH  |
| DP-151 | HALF SIZE FOIL LID                      | 12 13/16" x 10 7/16" x 5/8"  | 100 EACH |
| DP-152 | FULL SIZE DEEP 126G FOIL PAN            | 19 9/16" x 11 5/8" x 3 3/16" | 50 EACH  |
| DP-153 | HALF SIZE DEEP 40G FOIL PAN HEAVY DUTY  | 11 3/4" x 9 3/8" x 2 9/16"   | 100 EACH |
| DP-154 | FULL SIZE DEEP-110G FOIL PAN HEAVY DUTY | 19 9/16" x 11 5/8" x 3 3/16" | 50 EACH  |
| DP-155 | HALF SIZE DEEP-33G FOIL PAN HEAVY DUTY  | 11 3/4" x 9 3/8" x 2 9/16"   | 100 EACH |
| DP-157 | FULL SIZE WIRE STAND FOR FOIL TRAYS     | 22.5" L. X 12" W. X 9" H.    | 1 EACH   |

**CASE PACK**



**SOUP CROCK (ALUMINUM)**

MADE OF PEWTER-GLO (100% FOOD SAFE ALUMINUM ALLOYS). SOLD IN CASE PACK OF 6 EACH ONLY!

- CHI-330255 12 OZ., 3 3/4" DIA.

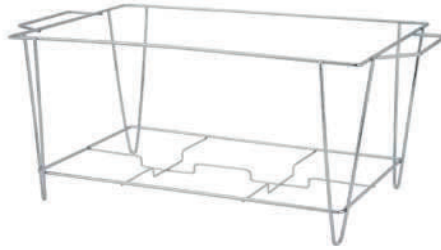

**CHROMEPLATED WIRE STAND FOR STEAM/WATER PANS, FULL-SIZE**

ONLY FITS STEAM TABLE PANS AND WATER PANS. DO NOT USE WITH ALUMINUM FOIL PANS.

- CH-7862 20.75" L. X 13" W. X 10" H.

# CHAFERS



**NEWBURG CHAFER (STAINLESS)**

TRIPLE WELDED WIDE STAINLESS STEEL LEGS FOR ADDED STRENGTH AND STABILITY. MIRROR POLISHED. FULL SIZE FOOD PAN, STANDARD WATER PAN, DUAL STERNO HOLDERS WITH EASY SNUFF COVERS. SOLD COMPLETE.  
CHSS-760B 8 QT., 24.6" L. x 14.3" W. x 10.4" H.



**FULL SIZE CHAFER (STAINLESS)**

STAY COOL PLASTIC HANDLE ON TOP OF CHAFER. WELDED LEGS. SOLD COMPLETE.

- CHSS-755 8 QT. CHAFER
- STP-4501 FOOD PAN
- CH-9151 8 QT. WATER PAN
- PT-755C COVER FOR CHSS-755



**FOLDING CHAFER (18/8 STAINLESS)**

CHAFER COMPLETE WITH WATER PAN, FUEL HOLDER, COVER AND FOLDING STAND.  
CHF-250 23.5" x 14" x 7"



**ROLLTOP CHAFERS (STAINLESS)**

ROLL TOP, HIGH POLISH AND HEAVY DUTY STAINLESS STEEL CHAFER. SOLD COMPLETE!

- CHSS-965 8 QT. RECTANGULAR CHAFE
- CHSS-965B 8 QT. RECTANGULAR CHAFE WITH BRAKE
- CHSS-970 6 QT. ROUND



**EVOLUTION CHAFER COLLECTION**

THE CHAFERS HAVE A SLOW RELEASE GLASS LID AND CAN BE BOUGHT WITHOUT OR WITHOUT THE STAND AND FUEL HOLDERS.

- CH-2200 7 QT. ROUND CHAFER WITH SPOON HOLDER, 20 1/2" L. x 20" W. x 12" H.
- CH-2201 STAND AND FUEL HOLDERS FOR CH-2200, 14 1/2" L. x 17" W. x 5 3/4" H.
- CH-2202 8 QT. RECTANGULAR CHAFER WITH SPOON HOLDER, 26" L. x 18" W. x 12" H.
- CH-2203 STAND WITH FUEL HOLDERS FOR CH-2202, 22" L. x 16" W. x 5 3/4" H.



**RECTANGULAR HINGED GLASS WINDOW LID CHAFER WITH STAND AND SPOON HOLDER**

HIGH POLISHED STAINLESS STEEL. USES STANDARD 2.5" DEEP FOOD PAN. HEAT SOURCES CAN BE CANNED FUEL, ELECTRIC, OR INDUCTION. THE VENTED GLASS WINDOW COVER ALLOWS GUEST TO VIEW THE BUFFET LINE OFFERINGS WITHOUT OPENING. A SELF CLOSING MECHANISM DRIP CHANNELS IN THE COVER REDIRECT WATER TO THE WATER PAN AND AWAY FROM THE FOOD.

CHSS-1950 8 QT.



**FULL SIZE CHAFER (STAINLESS)**

STAY COOL PLASTIC HANDLE ON TOP OF CHAFER. WELDED LEGS. SOLD COMPLETE.

- CHSS-755 8 QT. CHAFER
- STP-4501 FOOD PAN
- CH-9151 8 QT. WATER PAN
- PT-755C COVER FOR CHSS-755

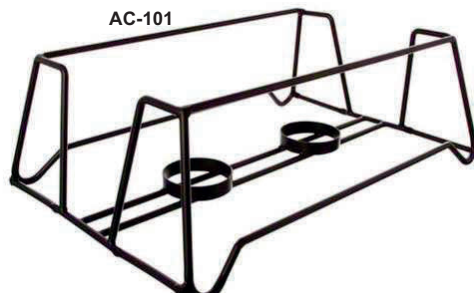
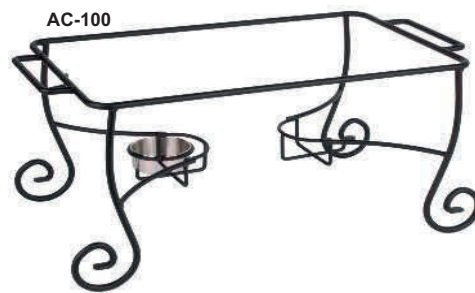

**CHAFER FRAME & CUP (WROUGHT IRON)**

WROUGHT IRON CHAFER FRAMES FITS STANDARD FULL SIZE CHAFER PANS.

- AC-100 CHAFER FRAME & CUP
- AC-101 STACKABLE CHAFER FRAME & CUP
- CH-100 KIT FITS AC-100, AC-101 INCLUDES FOOD PAN, LID, AND FUEL HOLDERS
- PT-100 FUEL HOLDER FIT AC-100, AC-101, CH-100, COMBO-100
- COMBO-100 COMBO AC-100 & CH-100
- COMBO-101 FULL CHAFER INCLUDES FOOD AND WATER PANS, LID, FUEL HOLDER AND FRAME
- COMBO-101 COMBO AC-101 & CH-100
- COMBO-101 FULL CHAFER INCLUDES FOOD AND WATER PANS, LID, FUEL HOLDER AND STACKABLE FRAME



**MESA CHAFERS**

180° ROLLTOP, WITH WROUGHT IRON ACCENTS. FEATURES A BUILT IN SPOON REST, FOOD PAN, WATER PAN, AND FUEL HOLDERS. SOLD COMPLETE.

- CH-1664 8 QT., 27 1/8" L. X 21 1/4" W. X 19 1/2" H. RECTANGULAR CHAFER STAINLESS STEEL COVER
- CH-1665 6 QT., 19" L. X 20" W. X 24" H. ROUND CHAFER STAINLESS STEEL COVER
- CHC-602 6 QT., 19" L. X 20" W. X 24" H. ROUND CHAFER HAMMERED COPPER COVER
- CHC-603 8 QT., 27 1/8" L. X 21 1/4" W. X 19 1/2" H. RECTANGULAR CHAFER HAMMERED COPPER COVER

# CHAFERS



**ADDITIONAL PARTS FOR WALCO IDOL COLLECTION**  
THESE ADDITIONAL PARTS ARE AVAILABLE AND FIT THE WALCO IDOL COLLECTION ONLY.

- FPP-315 PORCELAIN FOOD PAN FOR CH-315
- LD-315 GLASS LID FOR CH-315
- KT-315 GLASS LID, FOOD PAN, & SPOON HOLDER FOR CH-315
- PT-315 BURNER STAND AND TWO FUEL CUPS FOR CH-315
- FPP-316 PORCELAIN FOOD PAN FOR CH-316
- LD-316 GLASS LID FOR CH-316
- KT-316 GLASS LID, FOOD PAN, & SPOON HOLDER FOR CH-316
- PT-316 BURNER STAND AND ONE FUEL CUP FOR CH-316
- FPP-317 PORCELAIN FOOD PAN FOR CH-317
- FP-317 METAL FOOD PAN FOR CH-317
- KT-317 GLASS LID, FOOD PAN, & SPOON HOLDER FOR CH-317
- LD-317 GLASS LID FOR CH-317
- PT-317 BURNER STAND AND ONE FUEL CUP FOR CH-317
- FP-318 METAL FOOD PAN FOR CH-318
- KT-318 GLASS LID, FOOD PAN, & SPOON HOLDER FOR CH-318
- LD-318 GLASS LID FOR CH-318
- PT-318 BURNER STAND AND ONE FUEL CUP FOR CH-318
- SRG-318 ROUND SOUP STATION RING FOR CH-318
- KT-319 GLASS LID, FOOD PAN, & SPOON HOLDER FOR CH-319
- LD-319 GLASS LID FOR CH-319
- PT-319 BURNER STAND AND ONE FUEL CUP FOR CH-319
- LD-312 URN LID FOR UR-312 AND UR-319
- PT-312 URN SPIGOT FOR UR-312 AND UR-319



### IDOL COLLECTION

GLASS LID LIFT TOP CHAFERS AND SOUP STATIONS HAVE SELF CLOSING, VENTILATED LIDS TO KEEP FOOD FROM DRYING OUT. FOR ADDED CONVENIENCE, THE BODIES ARE REMOVABLE AND INDUCTION-READY. CHAFERS SOLD COMPLETE WITH FOOD PAN, SPOON HOLDER, BURNER STAND AND FUEL CUPS.

CD-313	9 LITER (9.5 QT)	CEREAL DISPENSER
CH-310	4 QT.	ROUND CHAFER WITH BODY GLASS WINDOW TOP LID FOOD PAN, SPOON HOLDER, BURNER STAND, & 1 EA. FUEL CUP
CH-314	4 QT., 9.63" DIA. x 12.63" H.	SAUCER WARMER
CH-315	8 QT.	RECTANGULAR CHAFER WITH BODY GLASS WINDOW TOP LID FOOD PAN, SPOON HOLDER, BURNER STAND, & 2 EA. FUEL CUPS
CH-316	4 QT.	RECTANGULAR CHAFER WITH BODY GLASS WINDOW TOP LID FOOD PAN, SPOON HOLDER, BURNER STAND, & 1 EA. FUEL CUP
CH-317	6 QT.	RECTANGULAR CHAFER WITH BODY GLASS WINDOW TOP LID FOOD PAN, SPOON HOLDER, BURNER STAND, & 1 EA. FUEL CUP
CH-318	7 QT.	ROUND CHAFER WITH BODY GLASS WINDOW TOP LID FOOD PAN, SPOON HOLDER, BURNER STAND, & 1 EA. FUEL CUP
CH-319	11.5 QT.	ROUND SOUP STATION WITH BODY GLASS WINDOW TOP LID
MD-320	1.5 GAL.	MILK DISPENSER
UR-311	1.5 GAL.	COFFEE URN WITH BASE AND FUEL HOLDER
UR-312	3.2 GAL.	COFFEE URN WITH BASE AND FUEL HOLDER
UR-319	5 GAL.	COFFEE URN WITH BASE AND FUEL HOLDER FOOD PAN, SPOON HOLDER, BURNER STAND, & 1 EA. FUEL CUP

### IDOL™ INDUCTION HINGED LID CHAFERS AND SOUP (STAINLESS STEEL & GLASS WINDOW)

- SELF CLOSING HINGED LID
- VENTED GLASS TOP - FOOD WON'T GET WET WITH CONDENSATION
- THIS ALLOWS FOR YOU TO SEE THE FOOD INSIDE AS WELL AS KEEP FOOD PRESENTATIONS FROM DRYING OUT
- MAGNETIC STEEL CLAD BOTTOMS INSURE EXCELLENT HEATING
- CAN ALSO BE USED ON INDUCTION

- ICH-315 8 QT. FULL SIZE RECTANGULAR CHAFER
- ICH-316 4 QT. HALF SIZE RECTANGULAR CHAFER
- ICH-317 6 QT. FULL SIZE RECTANGULAR CHAFER
- ICH-318 7 QT. FULL SIZE ROUND CHAFER
- ICH-319 11.5 QT. SOUP CHAFER



**DOME CHAFER COVERS ( STAINLESS)**  
CHC-800 FULL SIZE, 21" x 13" x 3.5"  
CHC-801 HALF SIZE, 13" x 10.5" x 3"



**FULL SIZE HINGED COVER (STAINLESS)**  
PT-CC1HDC 8 QT., FULL SIZE

# SOUP CHAFERS



**1 YEAR LIMITED MANUFACTURERS WARRANTY!**

### STAINLESS STEEL SOUP KETTLE

- ADJUSTABLE HEAT CONTROL DIAL
- HINGED NO-DRIP LID ALLOWS COVER TO BE OPENED
- DOUBLE WALL KEEPS THE OUTER SURFACE COOL
- INCLUDES THE INNER POT, SUCTION LABEL HOLDER, AND PRE-PRINTED SOUP LABELS
- 120 V, 60 HZ, 400 W

SW-6008 10 QT., 13 3/16" L. x 13 3/16" W. x 15" H.



### SOUP KETTLE

THE SOUP KETTLE IS CONSTRUCTED WITH A SCRATCH AND DENT RESISTANT HIGH IMPACT, HEAT-RESISTANT PLASTIC EXTERIOR AND AN INFINITE SWITCH.

SW-6003 11.4 QT., 110 V - 120 V AC, 500 W, 4 AMPS



### SOUP KETTLE

CORROSION RESISTANT ALUMINUM LINER AND A BLACK POWDER COATED STEEL SHELL. INCLUDES AN 11 QUART STAINLESS STEEL FOOD INSERT AND STAINLESS STEEL LID.

SW-6000 12 QT. 110V, 400W, 3.6 AMPS. UL LISTED



### ROUND SOUP CHAFER (STAINLESS STEEL)

- DAMPED-HINGED SELF-CLOSING LID
- COVER LIFTS OFF FOR EASY CLEANING
- SOUP CHAFER INCLUDES LADLE SIDE TRAY AND WORKS ON INDUCTION RANGES OR ON INCLUDED STAND WITH CANNED FUEL

CHSS-2511 11 QT., 22 X 20 X 17



### GRAVY WARMER/SERVER

TABLE MODEL HAS CANNED FUEL HOLDER. STEAM TABLE MODEL CAN BE DROPPED IN STEAM TABLE OR CAN BE ELECTRIFIED.

GRAVY WARMER:  
1.5 QT., 7.5" x 16.5" H.

INSERT:  
1.5 QT., 5.5" x 7.75" H. x 7.75" DEPTH

ACSS-30004 GRAVY WARMER  
ACC-30004 GRAVY WARMER CHROME  
ACI-30004 INSERT FOR ACSS-30004

### SOUP WARMER WITH INSERT AND WATER PAN (STAINLESS)



CH-3850 7 QT.  
CH-3851 11 QT.



### BRASS TRIM SOUP MARMITE

18/8 MIRROR FINISH STAINLESS STEEL WITH BRASS TRIM.

CHSS-46075  
7.25 QT.  
11.75" x 10.25" x 13.25"

**HEAVY DUTY!**

### IRONSTONE BAIN MARIE

THIS BAIN ARIE IS DOUBLE WALLED TO KEEP THE FOOD WARMER OR COLDER FOR LONGER PERIODS OF TIME. THE HAMMERED FINISH HIDES FINGERPRINTS AS WELL.

BS-5100

**NEW!**



### SOUP CHAFER/MARMITES (18/8 STAINLESS)

BRIGHT POLISH. WATER PAN AVAILABLE SEPARATELY.

CHSS-175 7 QT. SOUP CHAFER  
CHSS-176 WATER PAN FITS CHSS-175  
CHSS-178 11 QT. SOUP CHAFER  
CHSS-179 WATER PAN FITS CHSS-178

### HINGED ROUND COVER (18/8 STAINLESS)

STP-1872 OVER FITS CH-3850, CHSS-175  
STP-1873 COVER FITS CHSS-3851, CHSS-178

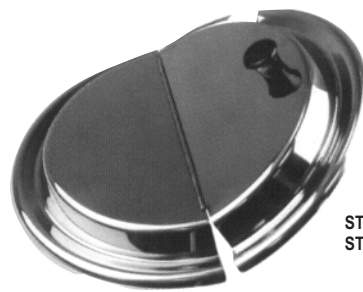

STP-1872  
STP-1873



### TWIN WELL RETHERMALIZER

TWIN WELL 4 QT. RETHERMALIZER, PACKAGE WITH TWO INSETS AND TWO HINGED COVERS. TWIN WELL 4 QUART CAPACITY, HOLDS TWO 4 1/8 QUART INSETS, INDIVIDUAL CONTROLS FOR SOUPS WITH DIFFERENT TEMPERATURE REQUIREMENTS, COATED ALUMINUM WELLS OFFER EASY CLEANING AND LONGER LIFE, 17.25" L. x 9.25" W. x 8.75" H., VOLTS:120 AC, WATTS:1100, AMPS:9.2, NSF CERTIFIED.

EQP-181 17.25" L. x 9.25" W. x 8.75" H.



### FOOD WARMER (18/8 STAINLESS)

THE INTERIOR LINER IS MADE OF 18/8 STAINLESS STEEL FOR EASY CLEANUP AND MAINTENANCE. A STEEL ELEMENT SUPPORT REFLECTS HEAT TOWARDS THE FOOD FOR EVEN HEAT DISTRIBUTION. EACH FOOD WARMER COMES COMPLETE WITH A 60" GROUNDED POWER CORD WITH A 3 PRONG MALE PLUG AND CAN HEAT UP WITHIN 10 MINUTES. MAINTAINS FOOD TEMPERATURE IN EXCESS OF 140 DEGREES.

120V/60 HZ., 1200 W., 10 AMPS. NSF AND UL APPROVED.

EQP-4500 EXTERIOR: 22.5" L. x 14.5" W. x 9.25" H.  
INTERIOR: 20" L. x 12" W. x 6.5" H.



STP-3100

STP-3103

STP-3108

AP-3105

STP-3104

STP-3102

### SUPER PAN® SUPER SHAPES STEAM TABLE PANS (STAINLESS)

- UNIQUE SHAPE DESIGN ENHANCES FOOD PRESENTATION
- UPSCALE FOOD PRESENTATION WITH MINIMAL INVESTMENT
- SHAPES PROVIDE DRAMATIC PRESENTATION AND REDUCED CAPACITY TO REDUCE FOOD WASTE
- PANS STACK NEATLY WITHIN THEMSELVES FOR EASY STORAGE
- 300 SERIES STAINLESS PROVIDES GREAT DURABILITY, CLEANABILITY AND THERMAL TRANSFER
- MADE IN U.S.A.
- NSF LISTED

STP-3100 4.8 QT. FULL OVAL, 20 1/4" L. X 12 13/16" W. X 2 1/2" D.  
STP-3101 5.1 QT. FULL KIDNEY, 20 1/2" L. X 12 13/16" W. X 2 1/2" D.  
STP-3102 2.2 QT. HALF OVAL, 10 1/4" L. X 12 13/16" W. X 2 1/2" D.  
STP-3103 2.2 QT. HALF KIDNEY, 10 1/4" L. X 12 13/16" W. X 2 1/2" D.  
STP-3104 3.7 QT. WILD SHAPE, 20 1/4" L. X 12 13/16" W. X 2 1/2" D.  
STP-3106 3.6 QT. HALF OVAL, 10 1/4" X 12 13/16" X 4" H.  
STP-3107 5.8 QT. FULL HEXAGON, 10 1/4" X 12 13/16" X 2 1/2" H.  
STP-3108 9.3 QT. FULL HEXAGON, 10 1/4" X 12 13/16" X 4" H.  
AP-3105 ADAPTER BAR FOR WILD PAN SHORT, STAINLESS STEEL

# FOOD CONTAINERS, FOOD PANS, & GRIDDLES

## STEAM TABLE FOOD PANS (STAINLESS STEEL)



STP-4501	(1/1) FULL SIZE PAN 2 1/2"	24 GAUGE
STP-4502	(1/1) FULL SIZE PAN 4"	24 GAUGE
STP-4503	(1/1) FULL SIZE PAN 6"	24 GAUGE
STP-4504	(1/1) FULL SOLID COVER	
STP-4505	(1/1) FULL SIZE NOTCHED COVER	
STP-4506	(1/2) HALF SIZE PAN 2 1/2"	24 GAUGE
STP-4507	(1/2) HALF SIZE PAN 4"	24 GAUGE
STP-4508	(1/2) HALF SIZE PAN 6"	24 GAUGE
STP-4509	(1/2) HALF SIZE SOLID COVER	
STP-4510	(1/2) HALF SIZE NOTCHED COVER	
STP-4511	(1/3) THIRD SIZE PAN 2 1/2"	24 GAUGE
STP-4512	(1/3) THIRD SIZE PAN 4"	24 GAUGE
STP-4513	(1/3) THIRD SIZE PAN 6"	24 GAUGE
STP-4514	(1/3) THIRD SIZE SOLID COVER	
STP-4515	(1/3) THIRD SIZE NOTCHED COVER	
STP-4501-22	(1/1) FULL SIZE PAN 2 1/2"	22 GAUGE
STP-4502-22	(1/1) FULL SIZE PAN 4"	22 GAUGE
STP-4503-22	(1/1) FULL SIZE PAN 6"	22 GAUGE
STP-4506-22	(1/2) HALF SIZE PAN 2 1/2"	22 GAUGE
STP-4507-22	(1/2) HALF SIZE PAN 4"	22 GAUGE
STP-4508-22	(1/2) HALF SIZE PAN 6"	22 GAUGE
STP-4511-22	(1/3) THIRD SIZE PAN 2 1/2"	22 GAUGE
STP-4512-22	(1/3) THIRD SIZE PAN 4"	22 GAUGE
STP-4513-22	(1/3) THIRD SIZE PAN 6"	22 GAUGE

### ADAPTER BARS FOR STEAM TABLE PANS

AC-4595	12" ADAPTER BAR	
AC-4596	20" ADAPTER BAR	

## CLEAR POLYCARBONATE FOOD PANS & FOOD COVERS

TEMPERATURE RANGES-40°F TO 210°F. DISHWASHER SAFE.



### POLY-WARE FOOD PANS

FP-1830	FULL SIZE 2.5"
FP-1831	FULL SIZE 4"
FP-1832	FULL SIZE 6"
FP-1833	HALF SIZE 2.5"
FP-1834	HALF SIZE 4"
FP-1835	HALF SIZE 6"
FP-1836	THIRD SIZE 2.5"
FP-1837	THIRD SIZE 4"
FP-1838	THIRD SIZE 6"
FP-1839	QUARTER SIZE 2.5"
FP-1840	QUARTER SIZE 4"
FP-1841	QUARTER SIZE 6"
FP-1842	SIXTH SIZE 2.5"
FP-1843	SIXTH SIZE 4"
FP-1844	SIXTH SIZE 6"
FP-1845	NINTH SIZE 2.5"
FP-1846	NINTH SIZE 4"

### POLY-WARE FOOD PAN COVERS

FPC-1847	FULL SIZE, SLOTTED
FPC-1848	HALF SIZE, SLOTTED
FPC-1849	THIRD SIZE, SLOTTED
FPC-1850	QUARTER SIZE, SLOTTED
FPC-1851	SIXTH SIZE, SLOTTED
FPC-1852	NINTH SIZE, SLOTTED
FPC-1853	FULL SIZE, SOLID
FPC-1854	HALF SIZE, SOLID
FPC-1868	THIRD SIZE, SOLID
FPC-1869	QUARTER SIZE, SOLID
FPC-1870	SIXTH SIZE, SOLID
FPC-1871	NINTH SIZE, SOLID

## PERFORATED STEAM TABLE PANS



STP-4535	FULL SIZE, 2 1/2"
STP-4536	FULL SIZE, 4"
STP-4537	FULL SIZE, 6"
STP-4538	HALF SIZE, 2 1/2"
STP-4539	HALF SIZE, 4"
STP-4540	HALF SIZE, 6"

## FOOD STORAGE CONTAINERS (POLYCARBONATE)



COVERS SOLD SEPARATELY.

	WHITE COLOR	CLEAR COLOR
2 QT. SQUARE	FSC-100	FSC-107
4 QT. SQUARE	FSC-101	FSC-108
6 QT. SQUARE	FSC-102	FSC-109
8 QT. SQUARE	FSC-103	FSC-110
12 QT. SQUARE	FSC-104	FSC-111
18 QT. SQUARE	FSC-105	FSC-112
22 QT. SQUARE	FSC-106	



### COVERS FOR SQUARE FOOD STORAGE CONTAINERS (POLYCARBONATE)

FSC-100C	COVER FITS 2 QT. & 4 QT.	GREEN
FSC-102C	COVER FITS 6 QT. & 8 QT.	RED
FSC-104C	COVER FITS 12 QT., 18 QT. & 22 QT.	BLUE

## DELI CROCKS



CR-2100	10" x 7" x 3"	RED
CR-2101	10" x 7" x 3"	BLACK
CR-2102	10" x 7" x 3"	CLEAR
CR-2103	13" x 10" x 3"	RED
CR-2104	13" x 10" x 3"	BLACK
CR-2105	13" x 10" x 3"	CLEAR

## STORAGE CANISTERS (STAINLESS STEEL)



CAN-400	30 OZ.	PLASTIC LID
CAN-401	45 OZ.	PLASTIC LID
CAN-402	55 OZ.	PLASTIC LID
CAN-403	70 OZ.	PLASTIC LID
CAN-500	30 OZ.	STAINLESS LID
CAN-501	45 OZ.	STAINLESS LID
CAN-502	55 OZ.	STAINLESS LID
CAN-503	70 OZ.	STAINLESS LID

## GLASS STORAGE JAR WITH CHROME COVER



SOLD IN CASE PACKS OF 4 EACH.

ST-1545	64 OZ.	7 1/4" H. x 4" T. x 4" B. x 6 7/8" D.
ST-1546	128 OZ.	8 1/8" H. x 4 3/4" T. x 5 7/8" B. x 8 5/8" D.

## ROUND WROUGHT IRON GRIDDLE AND STAND

THIS 18" GRIDDLE CAN BE PURCHASED AS A COMPLETE SET WITH THE STAND OR AS INDIVIDUAL PIECES, GIVING YOU MORE FLEXIBILITY TO MEET ALL OF YOUR FOOD SERVICE NEEDS AND DEMANDS.



GD-800	IRON GRIDDLE & STAND SET 18" DIA.
GD-801	GRIDDLE 18" DIA.
AC-1776	STAND 17" DIA.

## COUNTERTOP WARMING TRAY (STAINLESS)

FEATURES: HEAT CONTROLS AND SAFETY SIGNAL LIGHT, STEAM TABLE PANS, PANS NOT INCLUDED). LIMITED 1-YEAR WARRANTY. ELECTRICAL 120 VOLTS/300 WATTS/ 2.5 AMPS.

EQP-2371	20 1/2" x 14", ONE HEAT CONTROLS AND SAFETY SIGNAL LIGHTS ELECTRICAL 120 VOLTS/300 WATTS/ 2.5 AMPS
EQP-2371	41 1/4" x 14", TWO HEAT CONTROLS AND SAFETY SIGNAL LIGHTS 120 VOLTS/600 WATTS/5 AMPS



## COUNTERTOP WARMING TRAY

BLACK PORCELAIN ON STEEL WARMING SURFACE, 19" X 14" WARMING SURFACE, CONTROL KNOB ON TOP, 120 VOLTS/300 WATTS/2.5 AMPS. EQP-453 19" x 14"



## PAELLA PAN AND STAND

QUALITY CARBON STEEL NON-STICK FINISH WITH STAINLESS STEEL HANDLES FOR A LONGER USEABLE LIFE. COMBINED WITH THE WROUGHT IRON STAND AND FUEL HOLDER. ALL PARTS SOLD SEPARATELY.

AC-1775	PAELLA PAN, 21 5/8" DIA. WITH HANDLES
AC-1776	WROUGHT IRON STAND 17" DIA.
PT-1777	FUEL HOLDER, 3.75" DIA CUP x 6.75" W. (WITH HANDLE) BLACK WROUGHT IRON FLAT COIL



## GRIDDLES WITH STANDS (WROUGHT IRON)

GD-16	16" L. x 16" W. x 5" H., HALF SIZE GRIDDLE W/ WROUGHT IRON STAND
GD-27	27" L. x 16" W. x 5" H., FULL SIZE GRIDDLE W/ WROUGHT IRON STAND
PT-61	REPLACEMENT IRON GRIDDLE, FOR GD-16
PT-72	REPLACEMENT IRON GRIDDLE, FOR GD-27





# HEAT LAMPS & HOT DOG GRILL/STEAMER

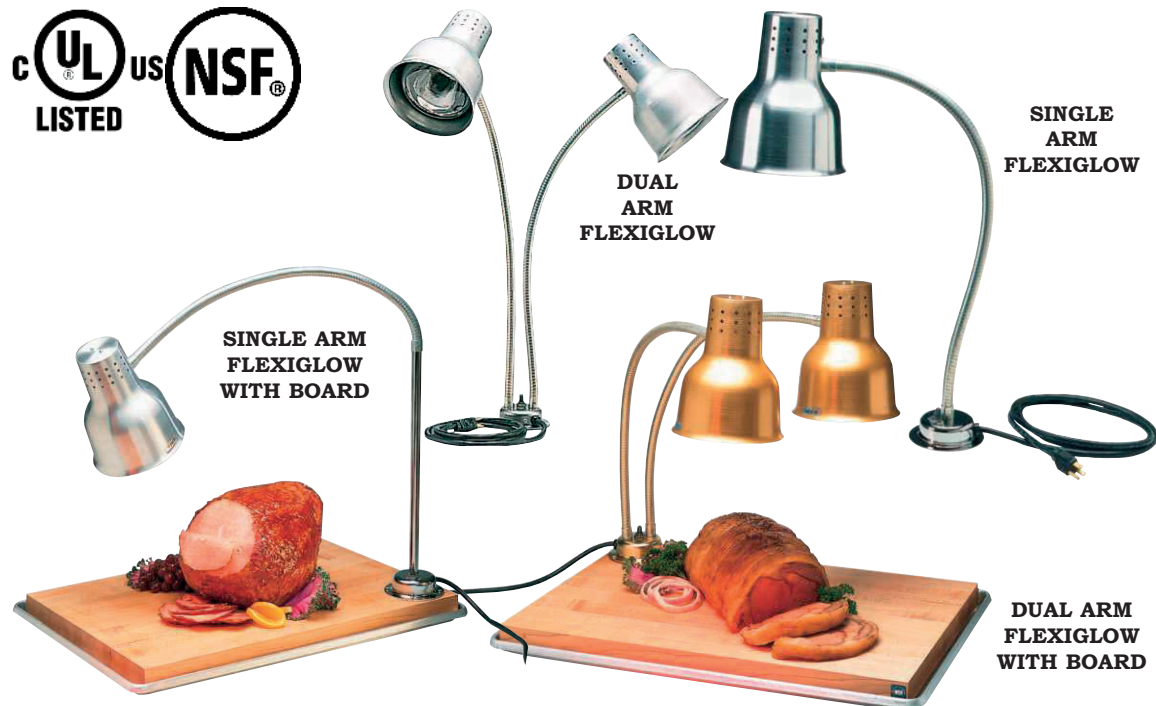

## HEAT LAMPS

FLEXIBLE AND ADJUSTABLE HEAT LAMP ARMS PROVIDE EVEN HEAT DISTRIBUTION. VINYL COATED ARMS HELP KEEP UNIT SANITARY. LAMPS INCLUDE TWO 250 WATT RED BULBS. UNITS FEATURE SPUN ALUMINUM SHADES WITH FLARED RIMS FOR ADDED STRENGTH AND DRILLED SHADES FOR INCREASED HEAT DISSIPATION. OPTIONAL MAPLE CUTTING BOARD AND DRIP PAN AVAILABLE. GOLD OR ANODIZED ALUMINUM FINISH OFFERS AN ELEGANT LOOK FOR CARVING STATIONS. PERFECT FOR CATERING, BANQUET HALLS, HOTELS, AND RENTAL COMPANIES. HEAT LAMPS ONE YEAR MANUFACTURER'S WARRANTY AGAINST DEFECTS. 120 V

### DUAL ARM FLEXIGLOW

- LT-1556 DUAL ARM FLEXIGLOW ONLY, ALUMINUM, 24" ARM
- LTG-1549 DUAL ARM FLEXIGLOW ONLY, GOLD, 24" ARM
- LTG-1550 DUAL ARM FLEXIGLOW WITH BOARD & PAN, GOLD, 24" ARM, 18" x 26" DRIP PAN AND 16" x 24" MAPLE CUTTING BOARD
- LT-82858 DUAL ARM FLEXIGLOW WITH BOARD & PAN, ALUMINUM, 24" ARM, 18" x 26" DRIP PAN AND 16" x 24" MAPLE CUTTING BOARD

### SINGLE ARM FLEXIGLOW

- LT-1557 SINGLE ARM FLEXIGLOW ONLY, ALUMINUM, 24" ARM
- LTG-1551 SINGLE ARM FLEXIGLOW ONLY, GOLD, 24" ARM
- LTG-1552 SINGLE ARM FLEXIGLOW ONLY, GOLD, 24" ARM, INCLUDES CLAMP FLEXIGLOW CLAMP ACCESSORY
- LT-1554 SINGLE ARM FLEXIGLOW ONLY, ALUMINUM, 39" ARM
- LTG-1553 SINGLE ARM FLEXIGLOW WITH BOARD & PAN, GOLD, 24" ARM, 18" x 26" DRIP PAN AND 16" x 24" MAPLE CUTTING BOARD
- LT-81858 SINGLE ARM FLEXIGLOW WITH BOARD & PAN, ALUMINUM, 24" ARM, 18" x 26" DRIP PAN AND 16" x 24" MAPLE CUTTING BOARD



### DUAL HEAT LAMP (ALUMINUM)

THE FLARED SHADES RESULT IN EVEN HEAT DISTRIBUTION, AND THE ON/OFF SWITCH IS CONVENIENTLY LOCATED ON THE ARM AWAY FROM THE HEAT ZONE. THE LAMP COMES COMPLETE WITH 2 CLEAR BULBS, 250W EACH.

LT-1500 ARM ADJUSTS FROM 15" TO 21" HIGH

### PROFESSIONAL FREE STANDING HEAT LAMP

THE FOUR POSITION ADJUSTABLE HEIGHT PROVIDES ADDED HEAT CONTROL FOR ANY FOOD OR EVENTS. INCLUDES A 6 FOOT POWER CORD SO YOU CAN PLUG IN ANYWHERE AND TWO 250W/120V SHATTER RESISTANT, VOLTAGE: 120V - 60 HZ, 6 FOOT POWER CORD. ETL LISTED FOR COMMERCIAL APPLIANCES. ETL SANITATION LISTED.

LT-1510 BASE: 14 1/4" D. x 16 1/4" W.

### HEAT LAMP

HEAT LAMP WITH ADJUSTABLE NECK. AVAILABLE IN YOUR CHOICE OF STAINLESS STEEL OR CHROMEPLATE FINISH. TELESCOPIC NECK ADJUSTS FROM 25.5" H. TO 35.5" FOR MAXIMUM TEMPERATURE CONTROL. AVAILABLE IN CHROMEPLATED OR STAINLESS STEEL WITH BRASS LAMP SHADE. 110V, 250 WATTS

LT-9686 BRASS ACCENT OR CHROME ACCENT



### ADJUSTABLE HEAT LAMPS (ALUMINUM)

FEATURES SPUN ALUMINUM SHADES WITH FLARED RIM FOR ADDED STRENGTH AND BETTER HEAT DISTRIBUTION. INCLUDES TWO 250-WATT CLEAR BULBS. CERAMIC INSULATED SOCKETS WITH NICKEL PLATED CONTACTS TO PREVENT FUSING. ON/OFF SWITCH MOUNTED ON ARM AWAY FROM HEAT ZONE.

- LT-7237 HEAT LAMP
- LT-7237PS HEAT LAMP, PAN, & DRIP SCREEN

### CARVING STATION

CARVING STATION WITH HEAT LAMP HAS ALL THE VITAL PIECES IN ONE COMPLETE UNIT. STAINLESS STEEL FRAME. INCLUDES DRIP TRAY AND BUTCHER BLOCK BOARD. ADDITIONAL CARVING BOARDS SOLD SEPARATELY. UL LISTED, 120VOLTS.



- LT-9698 21" x 13" x 30.5" CARVING STATION W/BUTCHER BLOCK BOARD
- CB-9698 CARVING BOARD ONLY 21" x 13" x 1.5



### PORTABLE HEAT LAMPS (CHROMEPLATE)

THESE HEAT LAMPS ARE FREE STANDING, MADE OF 18/8 STAINLESS STEEL THAT IS THEN CHROMEPLATED. IT IS PORTABLE AND COMES COMPLETE WITH THE BULB. THE MODERN & SLEEK LAMP HAS A FLEX NECK AND EXTRA STRONG STABILIZING BASE.



- LT-9669 SINGLE, 23" H.
- LT-6970 DOUBLE, 23" H.

### HOT DOG STEAMER

- FEATURES:
- STAINLESS STEEL BODY AND LIDS WITH TEMPERED GLASS
  - FITS 100 STANDARD SIZE HOT DOGS AND 36-48 BUNS
  - TOP LOADING DESIGN FOR EASY ACCESS TO CONTENTS
  - ADJUSTABLE THERMOSTAT WITH A HUMIDITY CONTROL SYSTEM KEEP BUNS FRESH WHILL HOT DOGS STEM
  - HOLDS UP TO 6 QUARTS OF WATER FOR ALL DAY STEAMING
  - 120V, 1200 W
  - 80°F- 185°F



HDS-1200  
WIDTH: 18 1/2" W., DEPTH: 14", HEIGHT: 16"

### HOT DOG ROLLER GRILL (STAINLESS)

THIS HOT DOG ROLLER GRILL HAS TWO INDEPENDENT KNOBS TO CONTROL THE FRONT AND BACK ROLLERS. 7 ROLLERS UNIT, HOLDS 18 HOT DOG. THE ROLLERS HAVE A COMPLETE 360° ROTATION. ENERGY: 120 V., 560 W., 60 HZ. CE AND NSF APPROVED.



EQP-4550 12" D. x 22.5" W. x 8" H.



# CONVECTION OVENS, MICROWAVES, & RANGES



### DOUBLE PORTABLE HEAVY DUTY RANGE

TWO CAST IRON ELEMENTS: 7 1/8" DIA. = 1,000 W, 6" DIA. = 650W, SIGNAL LIGHTS GLOW ONLY DURING HEAT CYCLE, EASY TO CLEAN STAINLESS HOUSING, INFINITE HEAT CONTROLS FOR EACH BURNER, 120 VOLTS/ 1650 WATTS/13.8 AMPS, UL SAFETY & SANITARY/C-UL.  
EQP-4380 DOUBLE RANGE, 10.25" W. x 2.5" H. x 11" DEPTH, 120 VOLTS



### SINGLE RANGE (CAST IRON)

HEAVY DUTY, 120 VOLTS/ 1500 ATTS/12.5 AMPS.  
EQP-2461 SINGLE RANGE, STAINLESS FINISH 9.5" W. x 3.25" H. x 10.25"  
EQP-2462 SINGLE RANGE, BLACK ENAMEL FINISH 9.5" W. x 3.25" H. x 10.25"

### BUFFET INDUCTION RANGE

IMMEDIATE POWER / FAST HEAT OFF AND A CERAMIC COOKING SURFACE. WORKS ONLY WITH POTS/PANS MADE OF CAST IRON, ENAMELED STEEL OR STAINLESS STEEL. FITS POTS/PANS 35/32" - 10 1/4" DIAMETER. LOW SILHOUETTE FOR COUNTERTOP BUFFET USE. ELECTRONIC CONTROL WITH AUDIBLE ACKNOWLEDGEMENT SIGNAL., BRUSHED STAINLESS STEEL HOUSING. CONTROL COOKING WITH POWER LEVEL OR TEMPERATURE LEVEL, 1-99 MINUTE TIMER, POWER LIGHT, TEMPERATURES FROM 160°F - 450°F, "RESIDUAL HEAT" SAFETY LIGHT OVER 160°F. 3 PRONG COMMERCIAL CORD SET, ETL LISTED, 120 VOLTS, 1400 WATTS, 11.7 AMPS.



EQP-4379  
12" W. x 3" H. x 16.25" DEPTH



### BUTANE STOVE

BUTANE STOVE WITH CYCLONE BURNER, 9560 BTU/HR, UL APPROVED. SOLD COMPLETE WITH PLASTIC CARRYING CASE.  
BS-5000 13" L. x 10 1/8" W. x 3" H.



### INDUCTION RANGE

IDEAL FOR PRESENTATION COOKING, OMELET STATIONS, OR SMALL RE-HEAT STATIONS. REAR BRACKET PROTECTS CORD AND PROVIDES PROPER VENTILATION. TEMPERATURE RANGE 140°F - 430°F. UNIT FEATURES NINE CONTROL SETTINGS AND A 120 AC VOLT, 1800 W.

EQP-1942 16 1/2" L. x 12 7/8" W. x 4" H.



### INDUCTION RANG

STAINLESS STEEL WITH CERAMIC TOP. ELECTRIC, PUSH-BUTTON OPERATION, 1800W, 120 VOLTS.  
EQP-1004 15.5" x 12" x 4.25", 140°F - 464°F



### ELECTRIC COUNTER TOP 1/2 SIZE CONVECTION OVEN (STAINLESS)

STOVE CONTAINS 2 MODES AND TEMPERATURE CONTROLS. HANDLES THREE STANDARD 1/2 SIZE SHEET PANS (NOT INCLUDED). HEAT SETTINGS FROM 175°F-500°F. FEATURES 120-MINUTE TIMER AND INDICATOR LIGHT. 120 VOLT.

- EQP-2375 23 5/8" W. x 15 7/8" H. x 22 5/8" L., 1/2 SIZE CONVECTION OVEN
- EQP-2380 ALUMINUM STAND W/ WHEELS FOR EQP-2375
- HOLDS OVEN AND 7 HALF SIZE SHEET PANS (NOT INCLUDED)
- EQP-3020 25"W x 16.25"H x 25"D, BLACK, OVEN CARRY BAG, FITS EQP-2375
- BAG FEATURES TEAR-PROOF MARINE GRADE RESIN MATERIAL. BLEACH AND WATER WASHABLE.



### ELECTRIC COUNTER TOP 1/4 SIZE CONVECTION OVEN (STAINLESS)

HANDLES THREE 1/4 SIZE SHEET PANS OR TWO 1/2 SIZE STEAM TABLE PANS, NO ROTATION NECESSARY. TOTALLY EVEN BAKING, HEAT RANGE FROM 175°F - 500°F, 120 MINUTE TIMER OR CONTINUOUS ON, EASY TO CLEAN STAINLESS FINISH, SAFETY COOL-TOUCH DOOR. NEMA 5-15P PLUG, 120 VOLTS - 1500 WATTS - 12.5 AMPS. 0.8 CUBIC FOOT. COOKING CHAMBER: 13 7/8" W. x 11.25" D. x 8 5/8"H.

EQP-2379 18 15/16" W. x 20 3/32" D. x 15 7/8"H, 1/4 SIZE CONVECTION OVEN



### COMMERCIAL CONVECTION OVEN

- STAINLESS STEEL CONSTRUCTION
- BUILT-IN 120 MINUTE TIMER WITH "STAY ON" FEATURE
- DUAL PAN TEMPERED GLASS DOOR
- INCLUDES THREE CHROME INTERIOR SHELVES
- WHISPER QUIET CIRCULATION
- ONE YEAR PARTS AND LABOR WARRANTY



EQP-500 1/2 SIZE 22 1/2" L. x 22 3/4" W. x 17 3/4" H. 120 V, 60 HZ, 1600 W, 13.3 A 1.5 CUBIC FT  
EQP-250 1/4 SIZE 18 3/4" L. x 19 7/8" W. x 15" H. 120 V, 60 HZ, 1440 W, 12 A 0.8 CUBIC FT.



### TOUCH CONTROL MICROWAVE

THIS COMMERCIAL TOUCH CONTROL MICROWAVE IS DURABLE AND ATTRACTIVE WITH A FULL STAINLESS STEEL EXTERIOR AND INTERIOR.

- 10 EASY TO PROGRAM FUNCTIONS
- 1,000 WATTS OF POWER FOR QUICK HEATING
- MOTOR DRIVEN BOTTOM ANTENNA FOR EFFICIENT DISTRIBUTION AND CONSISTENT RESULTS
- 0.9 CUBIC FEET OVEN CAPACITY
- CAN HOLD UP TO 12" DIAMETER PLATTER
- BACKLIT LED DISPLAY
- INTERIOR OVEN LIGHT
- 3 CUSTOMIZABLE KEY BEEP VOLUME LEVELS
- ONE YEAR WARRANTY

MV-500 20.1" W. x 17" D. x 12.2" H.



### DIAL CONTROL MICROWAVE

THIS COMMERCIAL DIAL CONTROL MICROWAVE IS DURABLE AND ATTRACTIVE WITH A FULL STAINLESS STEEL EXTERIOR AND INTERIOR.

- 1,000 WATTS OF POWER FOR QUICK HEATING
- BOTTOM ENERGY FEED SYSTEM WITH CERAMIC PLATE FOR EFFICIENT DISTRIBUTION AND CONSISTENT RESULTS
- 0.9 CUBIC FEET OVEN CAPACITY
- CAN HOLD UP TO 12" DIAMETER PLATTER
- BACKLIT LED DISPLAY
- INTERIOR OVEN LIGHT
- CUSTOMIZABLE COOKING TIMER FOR UP TO 60 MINUTES
- ONE YEAR WARRANTY

MV-505 20.5" W. x 17.9" D. x 12.3" H.



### HEAVY DUTY MANUAL COUNTERTOP CONVECTION OVEN

- MANUAL CONTROLS: TIME, TEMPERATURE, HUMIDITY
- INCLUDES ELECTRO VALVE FOR DIRECT WATER CONNECTION
- HANDLES 3 FULL SIZE SHEET PANS (NOT INCLUDED)
- ALSO HANDLES STEAM PANS
- THREE SHELVES INCLUDED
- COOKING CHAMBER IS 10" H. x 27.25" W. x 18.75" D. (3 CUBIC FEET)
- 60 MINUTE TIMER OR CONTINUOUS ON
- HEAT SETTINGS FROM 175°F - 500°F
- HIGH TEMPERATURE MOTOR BEARINGS
- REINFORCED DOOR DESIGN
- INTERIOR HALOGEN LIGHT
- 3" BETWEEN SHELVES
- THIS MODEL MUST SHIP BY TRUCK, NOT UPS

EQP-2196 31 1/5" W. x 32" L. x 19 7/8" H., 208-240 VOLTS, 4,600 WATTS, 20 AMPS

**PROOFERS**



**MOBILE CABINET**  
ALL WELDED, REINFORCED, NON-INSULATED ALUMINUM. DOUBLE PAN CONSTRUCTION WITH REINFORCED BRACES, 1.5 SPACING BETWEEN RUNNERS. EASILY MANEUVERABLE ON FOUR 5" POLYURETHANE, SWIVEL PLATE, DOUBLE BALL RACE CASTERS. 40 PAN CAPACITY. 18" x 26".

PRF-1840  
21" W. x 27" L. x 68" H.

**BEST BUY**



**UNDER COUNTER HEATER PROOFER**

THIS UNDER COUNTER HEATER/PROOFER IS PERFECT FOR TIGHT SPACES! THIS NON-INSULATED MODEL HAS A POLY TOP WORKSTATION AND BUMPERS ON THE CORNERS TO KEEP FROM MARKING/SCUFFING THE WALLS. 10 FULL SIZE SHEET PANS.

PRF-1842 21 1/4" W. x 32" L. x 30 2/3" H.



**INSULATED HEATER/PROOFER**

35% ENERGY SAVINGS! 100% PRE-TESTED ELECTRICAL ASSEMBLY HEAVY CHANNEL ALUMINUM CONSTRUCTION DESIGNED FOR DURABILITY. AIR BAFFLE AND CIRCULATION AIR BLOWER PROVIDE EVEN HEAT DISTRIBUTION. DUAL PROOF/HEAT CONTROL: PROOF MODE: HUMIDITY FROM 30% TO 100%. TEMPERATURES UP TO 115°F (46°C) HEAT MODE: NOMINAL TEMPERATURES UP TO 185°F (85°C) CLEAR DOOR, EXTRUDED ANODIZED ALUMINUM FRAME WILL NOT DULL. TIGHT GASKET FIT, THE DOOR LIFTS OFF FOR EASY CLEANING AND ACCESSIBILITY. UNIT HAS CORNER BUMPERS TO PROTECT WALLS.

PRF-1839  
HOLD 35 - 18" X 26" SHEET PANS  
21 1/2" W. X 32" L. X 66 1/2" H.



**HEATER / PROOFER**

NON-INSULATED HEATER PROOFER. AIR BAFFLE AND CIRCULATING AIR BLOWER PROVIDE EVEN HEAT DISTRIBUTIONS. CLEAR LEXAN DOOR. EASY DUAL PROOF/HEAT CONTROL. PROOF: HUMIDITY FROM 30% TO 95%. TEMPERATURES UP TO 115°F (46°C). HEAT: NOMINAL TEMPERATURES UP TO 180°F (82°C). ELECTRICAL: 120 VAC, 60 HZ., 14 AMPS - STANDARD 110 OUTLET. STANDARD 110 OUTLET.

PRF-1835  
21.5" W. x 31.25" L. x 69.5" H.

**GOOD**



**HEATER / PROOFER**

NON-INSULATED HEATER PROOFER. AIR BAFFLE AND CIRCULATING AIR BLOWER PROVIDE EVEN HEAT DISTRIBUTIONS. CLEAR LEXAN DOOR. EASY DUAL PROOF/HEAT CONTROL. PROOF: HUMIDITY FROM 30% TO 95%. TEMPERATURES UP TO 115°F (46°C). HEAT: NOMINAL TEMPERATURES UP TO 185°F (85°C). ELECTRICAL: 120 VOLT - 60 CYCLE A.C. 1440 WATTS, 14 AMPS - STANDARD 110 OUTLET.

PRF-1836  
21.5" W. x 31.25" L. x 69.5" H.

**BETTER**



**HEATER / PROOFER**

NON-INSULATED HEATER/ PROOFER. AIR BAFFLE AND CIRCULATING AIR BLOWER PROVIDE EVEN HEAT DISTRIBUTION. REMOVABLE CHROME PAN SLIDES FOR VARIABLE SPACING. REVERSIBLE DOOR FOR RIGHT OR LEFT HANGING STANDARD. 25 PAN SLIDES HOLD A VARIETY OF PAN CONFIGURATIONS. EASY DUAL PROOF/HEAT CONTROL. PROOF: HUMIDITY FROM 30% TO 95%. TEMPERATURES UP TO 115°F (46°C). HEAT: NOMINAL TEMPERATURES UP TO 185°F (85°C). ELECTRICAL: 120 VAC - 60 HZ., 14 AMPS - STANDARD 110 OUTLET. TRAYS NOT INCLUDED.

PRF-1837  
24" W. x 32" L. x 70" H.

**BEST**



**NON INSULATED HEATER PROOFER**

NON-INSULATED HEATER PROOFER CABINET IS IDEAL FOR ALL YOUR FOOD HOLDING AND PROOFING NEEDS. CONSTRUCTED OF NON-CORROSIVE ALUMINUM THROUGHOUT THE CABINET THAT ALLOWS YOU TO HOLD PREPARED FOODS AT PROPER SERVING TEMPERATURES FOR EXTENDED PERIODS OF TIME. THE AIR BAFFLE AND CIRCULATING AIR BLOWER PROVIDE EVEN HEAT DISTRIBUTION THROUGHOUT THE CABINET. A REMOVABLE CONTROL DRAWER WITH LED THERMOSTAT GIVES YOU COMPLETE CONTROL OVER THE OPERATING TEMPERATURE AND HUMIDITY RANGE AND DOESN'T REQUIRE OPENING THE DOOR TO USE. THIS ITEM COMES STANDARD WITH 5" HEAVY DUTY CASTORS AND A CLEAR LEXON DOOR WITH ALUMINUM FRAME. IT SHIPS KNOCKED DOWN AND IS EASY TO ASSEMBLE (TOOLS AND HARDWARE KIT INCLUDED). THE CABINET DIMENSIONS ARE 18"W X 26.25"D X 52.75"H WHICH WILL ALLOW YOU TO FIT 36- 18"X26" PANS (SOLD SEPARATELY). THE HEATING TEMPERATURE RANGE FOR THIS ITEM IS 80°F - 185°F AND A HUMIDITY PROOFING RANGE OF 30% - 95% (TEMPERATURE UP TO 115°F IN PROOF MODE). IT IS CE CERTIFIED AND IS BACKED BY 1 YEAR WARRANTY.



PRF-PW120  
21" W. x 31.25" D. x 67.25" H.



**NON-INSULATED DUTCH DOOR HEATER PROOFER**

THIS NON-INSULATED DUTCH DOOR HEATER PROOFER IS MADE WITH ALUMINUM TOP, SIDES, AND BOTTOM. THE DOORS HAVE AN ALUMINUM FRAME WITH LEXAN WINDOW, MAGNETIC DOOR GASKETS, AND INTEGRATED DOOR HANDLE. THE DUTCH DOOR DESIGN IS GREAT FOR THE DUAL PURPOSE OF HOLDING PRODUCT AT MEAL TIMES WHILE ALSO PROOFING DOUGH DURING PREP TIME. THE DUTCH DOOR DESIGN ALSO REDUCES HEAT LOSS.

**DUTCH DOORS**



- HOLDS 33 - 18" X 36" OR 66 - 14" X 18" SHEET PANS WITH 1 1/2" SPACING
- REMOVABLE DRIP PAN
- POWER ON/OFF AND PROOF/HEAT SWITCH
- ADJUSTABLE HEAT AND HUMIDITY CONTROLS
- DUAL CONTROLS, ONE FOR HEAT (UP TO 180°F) AND ONE TO CONTROL PROOF/HUMIDITY (UP TO 95% AT 110°F)
- INTERNAL WATER PAN IS STAINLESS STEEL
- FOUR 5" POLYURETHANE SWIVEL CASTERS, WITH 2 BRAKES
- EACH DOOR IS 27" H. X 20 1/2" W.
- ONE YEAR LIMITED MANUFACTURERS PARTS AND LABOR WARRANTY
- 1440 WATTS, 120 VOLTS, 60 Hz, 14 AMPS
- NSF AND ETL LISTED

PRF-1845 20 1/2" W. X 32 1/3" L. X 66 1/2" H.



**SHEET PAN TRUCK (ALUMINUM)**

THIS ALUMINUM SHEET PAN TRUCK IS AN ESSENTIAL TOOL FOR ANY BUSY AND HECTIC KITCHEN! EACH TRUCK WILL HOLD UP TO 54 FULL SIZE (18" X 26") OR 108 HALF SIZE (13" X 18") SHEET PANS. THE ALUMINUM SHEET PAN TRUCK IS SHIPPED KNOCKED DOWN AND INCLUDES FULL SWIVEL CASTERS FOR EASY MANEUVERABILITY. THE DURABLE TRUCK IS MADE OF 14 GAUGE ALUMINUM WITH 1" EXTRUDED ALUMINUM TUBE FRAME WITH 5" DIAMETER X 1 1/4" WIDTH FULL SWIVEL CASTER, SO IT WILL HOLD UP TO YOUR BUSIEST EVENTS! SHIP KNOCKED DOWN.

CART-1700 SHEET PAN TRUCK, 20 5/8" W. x 28 7/8" D. x 33 3/8" H.  
CST-1700 CASTERS WITH BRAKE ONLY FOR CART-1700

## PAN RACKS & SHEET PANS



### WELDED, NESTABLE "Z" FRAME ALUMINUM SHEET PAN RACKS

THESE ULTRA HEAVY DUTY, END-LOADING WELDED RACKS ARE TRULY REMARKABLE. THE UNIQUE "Z FRAME" CONSTRUCTION ALLOWS THE RACKS TO NEST WHILE NOT IN USE, SAVING HUGE AMOUNTS OF SPACE. RIBBED SLIDES FOR EASIER LOADING AND UNLOADING OF PANS. INCLUDES 5" NON-MARKING POLYURETHANE CASTERS - 2 SWIVEL & 2 SWIVEL WITH BRAKES. 20 13/16" X 26" X 70" H.

EQP-12	12 PAN CAPACITY	20 13/16" X 26" X 70" H	5" SPACING
EQP-20	20 PAN CAPACITY	20 13/16" X 26" X 70" H	3" SPACING



### SHEET PAN RACKS (ALUMINUM)

HEAVY DUTY ALUMINUM SHEET PAN RACK. ASSEMBLY REQUIRED.

EQP-11234	10 TIER RACK	26" L. x 20 1/4" W. x 69 1/4" H.
EQP-11235	10 TIER RACK	26.5" L. x 20.25" W. x 38.75" H.
EQP-11236	20 TIER RACK	26.5" L. x 20.25" W. x 60" H.
EQP-11237	COVER	FOR EQP-11233 & EQP-11235
EQP-11238	COVER	FOR EQP-11234 & EQP-11236



### NESTING KNOCK-DOWN Z RACK, ALUMINUM

THIS Z-RACK IS A KNOCK-DOWN NESTING UNIT WHICH CAN SAVE ON SPACE AT YOUR LOCATION OR EVENT WHEN NOT IN USE. YOU CAN STORE AND TRANSPORT FINISHED AND UNFINISHED PRODUCT FOR QUICK ACCESS. THE CROSS BRACES ARE HEAVY WALL TUBING. THE CASTERS ARE INSERTED INTO REINFORCES SOCKET EXTRUSION FOR ADDED STRENGTH.

- HOLDS 20 PANS, 18" X 26" OR 14" X 18" SHEET PANS WITH 3" SPACING
  - 1" SQUARE ALUMINUM TUBING
  - 1" X 1 1/2" RUNNER ANGLES
  - FOUR 5" POLYURETHANE SWIVEL CASTERS, TWO WITH LOCKS
  - KNOCK-DOWN DESIGN CAN ASSEMBLE IN MINUTES
  - LIFETIME MANUFACTURERS WARRANTY AGAINST RUST
- EQP-220 26" L. X 21" W. X 70" H.



### ALUMINUM SHEET PAN RACK

10 TIER ALUMINUM SHEET PAN RACK COMES WITH WHEELS. NSF CERTIFIED. ASSEMBLY REQUIRED.

EQP-11233  
20 1/4" x 26" x 38 1/2"



### COUNTER HEIGHT SHEET PAN RACK WITH RAILS (ALUMINUM)

15 TIER RACK WITH SLIDES AND HARD TOP CAN BE USED AS CUTTING BOARD STAND, CASTERS ARE FULL SWIVEL, 5" DIA. x 1.25", CAPACITY: 15 FULL SIZE (18" x 26") OR 30 HALF SIZE (18" x 13") SHEET PANS.

CART-1701  
20 7/8" W. x 26 1/8" D. x 31 5/8" H.



### SHEET PANS (ALUMINUM)

PAN-1585	FULL SIZE	18" x 26" x 1"
PAN-1586	FULL SIZE	18" x 26" x 1"
PAN-1584	HALF SIZE	18 GAUGE, 12 7/8" x 17 3/4" x 1"
PAN-68373	FULL SIZE, PERFORATED	25 3/4" x 17 3/4" x 1"
PAN-68375	HALF SIZE, PERFORATED	12 7/8" x 17 3/4" x 1"
PAN-68379	QUARTER SIZE	13" x 9" x 1 1/8"
PAN-68380	QUARTER SIZE, CLOSED BEAD	10" x 13"

### SHEET PANS (STAINLESS)

PAN-68376	2/3 SIZE 16" x 22"	CLOSE BEAD
PAN-68377	FULL SIZE 18" x 26"	CLOSE BEAD
PAN-68405	FULL SIZE 18" x 26" x 1"	OPEN BEAD, PERFORATED
PAN-68406	HALF SIZE 13" x 18" x 1"	OPEN BEAD

### PIZZA PAN RACK

THIS PIZZA PAN RACK HAS 15 SLOTS, MAKING IT A GREAT ADDITION TO ANY DELI, PIZZERIA OR RESTAURANT. THE RACK WILL HOLD A RANGE OF PIZZA PAN SIZES, SO YOU CAN KEEP TRACK OF THE PIZZAS AS THEY GO IN OR COME OUT OF THE OVEN. 15 SLOTS.

PZ-191  
27" L. x 12" W. x 11.5" H.



### PIZZA PANS (ALUMINUM)

PZ-100	8" DIA.	COUPE
PZ-101	9" DIA.	COUPE
PZ-102	10" DIA.	COUPE
PZ-103	11" DIA.	COUPE
PZ-104	12" DIA.	COUPE
PZ-105	13" DIA.	COUPE
PZ-106	14" DIA.	COUPE
PZ-107	15" DIA.	COUPE
PZ-108	16" DIA.	COUPE
PZ-109	18" DIA.	COUPE
PZ-150	8" DIA.	WIDE RIM
PZ-151	10" DIA.	WIDE RIM
PZ-152	11" DIA.	WIDE RIM
PZ-153	12" DIA.	WIDE RIM
PZ-154	13" DIA.	WIDE RIM
PZ-155	14" DIA.	WIDE RIM
PZ-156	15" DIA.	WIDE RIM
PZ-157	16" DIA.	WIDE RIM
PZ-158	17" DIA.	WIDE RIM
PZ-159	18" DIA.	WIDE RIM
PZ-160	19" DIA.	WIDE RIM
PZ-161	20" DIA.	WIDE RIM



### COOKIE SHEETS (ALUMINUM)

HEAVY 10 GAUGE ALUMINUM HEATS RAPIDLY AND EVENLY.

PAN-68084	STEEL COATED x 3 PREMIUM NON STICK	17" x 14"
PAN-68085	NATURAL FINISH ALUMINUM	17" x 14"



SILICONE BAKE & WORK MATS FIT ALL STANDARD FULL, HALF SIZE, AND QUARTER SIZE SHEET PANS. FOOD GRADE SILICONE OVER REINFORCED FIBERGLASS TO WITHSTAND TEMPERATURES UP TO 500° F (260° C). NATURALLY NON-STICK SO NO GREASE, FATS, OR OILS ARE NEEDED. SAFE FOR USE IN OVEN, FREEZER, OR MICROWAVE

BK-152	QUARTER SIZE SILICONE BAKE MAT	11 3/4" x 8"
BK-153	HALF SIZE SILICONE BAKE MAT	16 1/2" x 11 9/10"
BK-154	FULL SIZE SILICONE BAKE MAT,	24 1/2" x 16 1/2"



### DOUBLE ROASTER COMBINATION (HEAVY DUTY ALUMINUM)

PAN-68410	ROSTER W/ STRAPS	18" W. x 24" L. x 4.5" D.
PAN-68411	ROSTER W/ STRAPS & LUGS	18" W. x 24" L. x 4.5" D.



### BAKE/ROAST PANS (HEAVY DUTY ALUMINUM)

PAN-68415	25.75" L. x 17.75" W. x 2.25" D., WITHOUT HANDLE
PAN-68416	25.75" L. x 17.75" W. x 3.5" D., WITH DROP HANDLE



### BAKE PAN (ALUMINUM)

THIS BAKE PAN IS MADE OF ALUMINUM AND FEATURES A DROP HANDLE, MAKING IT EASIER TO PICK UP AND REMOVE FROM THE OVEN.

PAN-68417  
17.75" L. x 11.5" W. x 2.25" D.

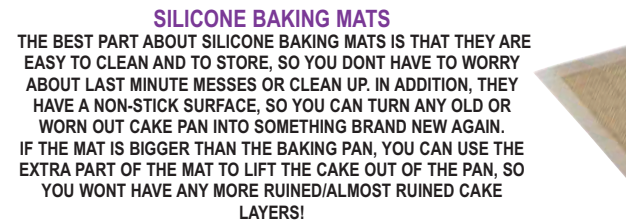

### SILICONE BAKING MATS

THE BEST PART ABOUT SILICONE BAKING MATS IS THAT THEY ARE EASY TO CLEAN AND TO STORE. SO YOU DONT HAVE TO WORRY ABOUT LAST MINUTE MESSSES OR CLEAN UP. IN ADDITION, THEY HAVE A NON-STICK SURFACE, SO YOU CAN TURN ANY OLD OR WORN OUT CAKE PAN INTO SOMETHING BRAND NEW AGAIN. IF THE MAT IS BIGGER THAN THE BAKING PAN, YOU CAN USE THE EXTRA PART OF THE MAT TO LIFT THE CAKE OUT OF THE PAN, SO YOU WONT HAVE ANY MORE RUINED/ALMOST RUINED CAKE LAYERS!

BK-605	11 7/8" x 16 1/2"	FITS HALF SIZE
BK-606	15 3/8" x 21 1/2"	FITS 2/3 SIZE
BK-607	16 3/8" x 24 1/2"	FITS FULL SIZE

**CONFECTION MACHINES, PIZZA OVENS, & COOKWARE**

**COUNTERTOP PIZZA OVEN**

- DUAL INDEPENDENTLY CONTROLLED HEATING ELEMENTS
- 60 MINUTE TIMER WITH BELL INCLUDES "STAY ON" FEATURE
- PIZZA TRAY HANDLE FOLDS FOR STORAGE
- INCLUDES CRUMB TRAY
- FITS UP TO A 12" PIZZA
- 12V, 60HZ, 1500W, 12.5A

EQP-750 20 7/8" W. X 14.76" D. X 9.25" H.L. x 14 3/4" W. x 9 1/4" H.



**PIZZA/SNACK OVEN (STAINLESS)**

THE 13 1/2" RACK WILL ACCOMMODATE PRODUCTS UP TO 12" DIAMETER AND 2 1/2" TALL. UPPER AND LOWER HEATING ELEMENTS FOR EVEN COOKING WITH A 450°F PRE-SET THERMOSTAT AND ON/OFF OPERATION WITH A 30 MINUTE TIMER. ENERGY: 120 V., 1450 W., 12 AMPS.

PZ-5500



**ELECTRIC HEATED DISPLAY PIZZA**  
THIS HEATED DISPLAY MERCHANDISER IS IDEAL FOR PIZZA, PRETZELS, OR CONCESSIONS.

- PASSIVE HUMIDITY CONTROL WITH REMOVABLE WATER TRAY
- HOLDS UP TO FOUR 14" DIAMETER PIZZAS
- LIGHTED DISPLAY PANEL FOR BRANDED PRODUCTS
- REMOVABLE CHROME TRAY
- 120V, 60HZ, 875W, 7.3 AMPS
- 49 LBS.

CS-820 ELECTRIC HEATED MERCHANDISER, 17.6" W. X 18.1" D. X 30.9" H.

CS-821 PRETZEL RACK FOR MERCHANDISER

**COUNTERTOP COTTON CANDY MACHINE**

- EASY TO USE CONTROLS
- INCLUDES SUGAR SCOOP FOR POURING FLOSS SUGAR
- 20.5" DIAMETER STAINLESS STEEL BOWL
- THE SPINNER HEAD CAN ACCOMMODATE UP TO 4 OUNCES OF FLOSS SUGAR
- EASY ACCESS TO VOLTAGE METER AND FUSE FOR USE WITH GENERATORS AND POWER SUPPLIES
- OPTIONAL LID IS SOLD SEPARATELY
- 120V, 60HZ, 1080W, 9AMPS
- 27 LBS.

CS-2800 ELECTRIC COTTON CANDY MACHINE, 20.5" W. x 20.5" D. x 19" H.  
CS-2800C PLASTIC COVER FOR MACHINE, 21" W. x 21" D. x 14" H.



**POPCORN POPPER**

THIS POPCORN MACHINE TAKES 3 TO 4 MINUTES TO PREHEAT AND KEEPS THE POPCORN HOT AND READY TO BE SERVED. THE POPCORN ARTWORK WILL CATCH THE EYES OF YOUR CUSTOMERS FROM MILES AWAY. PERFECT FOR STATE FAIRS, STADIUMS, AND FUNDRAISING EVENTS.

CS-910 30" H. RED, 1350W



**COMMERCIAL ELECTRIC POPCORN POPPER**

- 8 OZ. STAINLESS REMOVABLE KETTLE
- BUILT IN WARMER LIGHT
- REMOVABLE CRUMB TRAY
- TEMPERED GLASS SIDE PANELS
- CLEAR PLEXIGLASS DOORS & STAINLESS STEEL FOLD OUT TRAY FOR EASY ACCESS TO POPCORN
- 120V, 60HZ, 1350W, 12AMPS
- 55 LBS.

CS-810 22" W. x 16.5" D. x 30" H., RED



**COTTON CANDY MACHINE**

EACH MACHINE HAS A 21" DIA. STAINLESS STEEL BOWL AND CAN PRODUCE 2 CONES PER MINUTE. THE SPINNER HOLDS 4 OZ OF FLOSS SUGAR BEFORE MELTING INTO COTTON CANDY. GREAT FOR HIGH VOLUME OPERATIONS.

CS-2900 COTTON CANDY MACHINE WITH SUPPLY DRAWER  
CS-2901 COTTON CANDY MACHINE WITHOUT SUPPLY DRAWER  
CS-2902 PLASTIC COVER FOR COTTON CANDY MACHINE

**LIMITED MANUFACTURERS WARRANTY!**



**ELECTRIC POPCORN POPPER**

- 8 OZ STAINLESS STEEL REMOVABLE KETTLE
- BUILT IN WARMER LIGHT
- REMOVABLE CRUMB TRAY
- TEMPERED GLASS SIDE PANELS
- CLEAR PLEXIGLASS DOORS AND STAINLESS STEEL FOLD OUT TRAY FOR EASY ACCESS
- 120V, 60HZ, 1130W, 9.5AMPS
- 36 LBS.

CS-800 15.75" W. x 14.75" D. x 23" H., BLACK



**COMMERCIAL POPCORN MACHINE**

THIS POPCORN MACHINE HAS AN 8 OZ KETTLE AND 3-SWITCH OPERATION TO MAKE USING THE MACHINE QUITE SIMPLE. FEATURES 8 OZ KETTLE, TAKES 3 TO 4 MINUTES TO PREHEAT. SOLD COMPLETE WITH A SMALL PLASTIC SCOOP AND MEASURING SPOONS. 120V, 850W, NEMA 5-15P PLUG

CS-900 15" W. X 12 1/4" D. X 24" H. POPCORN MACHINE  
CRT-900 CART ONLY FOR CS-900 POPCORN MACHINE



**TRI-PLY MINI COOKWARE**

THESE SINGLE SERVE PORTION PANS COME IN A COPPER OR STAINLESS EXTERIOR. THE TRI-PLY CONSTRUCTION WORKS ON ALL HEAT SOURCES. THE COOKING SURFACE IS 18/8 STAINLESS STEEL FOR SUPERIOR COOKING PERFORMANCE. EACH PAN HAS AN ALUMINUM CORE TO PROVIDE EVEN HEAT DISTRIBUTION.

PAN-3300	15 OZ., 3.75" CASSEROLE	STAINLESS EXTERIOR
PAN-3300C	15 OZ., 3.75" CASSEROLE	COPPER EXTERIOR
PAN-3301	5 OZ., 4" FRY PAN	STAINLESS EXTERIOR
PAN-3301C	5 OZ., 4" FRY PAN	COPPER EXTERIOR
PAN-3302	5 OZ., 3" SAUCIER	STAINLESS EXTERIOR
PAN-3302C	5 OZ., 3" SAUCIER	COPPER EXTERIOR
PAN-3303	11 OZ., 3.5" SAUCE PAN	STAINLESS EXTERIOR
PAN-3303C	11 OZ., 3.5" SAUCE PAN	COPPER EXTERIOR
PANC-3300	LID FOR CASSEROLE, PAN-3300 AND PAN-3300C	
PANC-3303	LID FOR SAUCE PAN, PAN-3303 AND PAN-3303C	

**7 PC COOKWARE SET (HEAVY WEIGHT STAINLESS STEEL)**

THIS COOKWARE SET CONSISTS OF A 1 QUART COVERED SAUCE PAN, A 2 QUART COVERED SAUCE PAN, A 5 QUART COVERED DUTCH OVEN, AND A 9 1/2" SAUTÉ PAN. ALL THE PANS HAVE AN ALUMINUM CORE FOR FAST AND EVEN HEAT DISTRIBUTION, THAT IS THEN BONDED BETWEEN TWO LAYERS OF STAINLESS STEEL TO ENSURE A LIFETIME OF USE. THEY ARE HEAVY WEIGHT STAINLESS STEEL, THE HANDLES ARE DOUBLE RIVETED, AND INDUCTION READY. SOLD IN THE SET ONLY.

POTS-750 7 PC COOKWARE SET



**NEW!**



**NEW!**

**SEAFOOD SERVERS WITH LID (STAINLESS STEEL)**

THESE SERVERS ARE ELEGANT AND MADE FROM DURABLE STAINLESS STEEL. SOLD IN CASE PACK OF 4.

POT-550 64 OZ., 7" DIA. X 6 3/4" H. (9" DIA. WITH HANDLES)  
POT-551 118 OZ., 7 3/4" DIA. X 7 3/4" H. (10 1/2" DIA. WITH HANDLES)

**ALUMINUM FRYER WITH BASKET**

HEAVY DUTY 3004 ALUMINUM PAN SOLD COMPLETE WITH ALUMINUM FRYER BASKET. BASKET HOLES ARE 3/16" DIA.

FRY-68227 9 QT. PAN: 12" DIA. x 4 7/8" DEPTH BASKET: 11" DIA.

FRY-68228 12 QT. PAN: 14" DIA. x 4.5" DEPTH BASKET: 12 7/8"

**FESTIVAL FAVORITE!**



**BOILER/FRYER WITH BASKET**

3004 ALUMINUM. BAIL HANDLE FOR EASY REMOVAL AND DRAINING. SET INCLUDES POT, PERFORATED BASKET WITH BAIL HANDLE, AND COVER.

STM-68270 40 QT.



# COOKWARE

## STOCK POTS AND COVERS (ALUMINUM)

HEAVY DUTY. NSF LISTED. HAND WASH. POTS AND COVERS SOLD SEPARATELY.



### STOCK POT

POT-4708	8 QT.
POT-4712	12 QT., 10" DIA. x 9.25" H.
POT-4716	16 QT., 10" DIA. x 12" H.
POT-4720	20 QT., 12" DIA. x 10.5" H.
POT-4724	24 QT., 12" DIA. x 12.5" H.
POT-4740	40 QT., 14" DIA. x 15" H.
POT-4760	60 QT., 16" DIA. x 17" H.
POT-4780	80 QT., 18" DIA. x 18.25" H.
POT-47100	100 QT., 20" DIA. x 17.7" H.
POT-47120	120 QT., 21.7" DIA. x 19.5" H.
POT-47140	140 QT., 22.8" DIA. x 20.3" H.

### POT COVER

POTC-4708	COVER FOR POT-4708
POTC-4712	COVER FOR POT-4712
POTC-4716	COVER FOR POT-4716
POTC-4720	COVER FOR POT-4720
POTC-4724	COVER FOR POT-4724
POTC-4740	COVER FOR POT-4740
POTC-4760	COVER FOR POT-4760
POTC-4780	COVER FOR POT-4780
POTC-47100	COVER FOR POT-47100
POTC-47120	COVER FOR POT-47120
POTC-47140	COVER FOR POT-47140

## STOCK POT WITH COVER (STAINLESS STEEL)

COMMERCIAL-QUALITY PREMIUM STAINLESS STEEL. TRI-PLY HEAVY-DUTY BOTTOM FOR EVEN HEAT DISTRIBUTION. EXTRA STURDY WELDING ON HANDLES. INDUCTION READY. NSF LISTED.



POT-1916	8 QT.	9 1/2" DIA. x 6 3/4" H.
POT-1917	12 QT.	11" DIA. x 7 1/8" H.
POT-1918	16 QT.	11" DIA. x 9 3/4" H.
POT-1919	20 QT.	11 3/4" DIA. x 10 1/4" H.
POT-1920	24 QT.	13 3/8" DIA. x 10 1/4" H.
POT-1921	32 QT.	14 1/4" DIA. x 11 3/4" H.
POT-1922	40 QT.	15 3/4" DIA. x 11 3/4" H.
POT-1923	60 QT.	17 3/4" DIA. x 14 1/4" H.
POT-1924	80 QT.	19 3/4" DIA. x 15 3/4" H.

## STOCK POTS (ALUMINUM)

HEAVY DUTY. NSF LISTED. HAND WASH. POTS AND COVERS SOLD SEPARATELY.



POT-3400	16 QT.	10" DIA. x 12" H.
POT-3401	20 QT.	12" DIA. x 10 1/2" H.
POT-3402	24 QT.	12" DIA. x 12 1/2" H.
POT-3403	32 QT.	13" DIA. x 14" H.
POT-3404	40 QT.	14" DIA. x 15" H.
POT-3405	60 QT.	16" DIA. x 17" H.
POT-3406	80 QT.	18" DIA. x 18 1/4" H.

## STOCK POTS (ALUMINUM)

HEAVY DUTY. NSF LISTED. HAND WASH. POTS AND COVERS SOLD SEPARATELY.



POT-3300	8.5 QT.	10" DIA. x 6 1/2" H.
POT-3301	10 QT.	10" DIA. x 7 12" H.
POT-3303	16 QT.	10" DIA. x 12" H.
POT-3304	20 QT.	12" DIA. x 10 1/2" H.
POT-3306	32 QT.	13" DIA. x 14" H.
POT-3307	40 QT.	14" DIA. x 15" H.
POT-3308	60 QT.	16" DIA. x 17" H.
POT-3309	80 QT.	18" DIA. x 18 1/4" H.

## STOCK POTS (ALUMINUM)

HEAVY DUTY. NSF LISTED. HAND WASH. POTS AND COVERS SOLD SEPARATELY.



POT-3100	14 QT.	12" DIA. x 7 1/2" H.
POT-3101	20 QT.	13" DIA. x 9" H.
POT-3102	26 QT.	14" DIA. x 10" H.
POT-3103	34 QT.	16" DIA. x 10" H.

## COVER (ALUMINUM) HEAVY HEAVY DUTY NSF LISTED. HAND WASH. POTS AND COVERS SOLD SEPARATELY.



POTC-3500	COVER ONLY FOR POT-3300, POT-3301, POT-3302, POT-3303 & POT-3400
POTC-3501	COVER ONLY FOR POT-3304, POT-3305, POT-3401, POT-3402 & POT-3100
POTC-3502	COVER ONLY FOR POT-3306, POT-3403 & POT-3101
POTC-3503	COVER ONLY FOR POT-3307, POT-3200, POT-3102 & POT-3404
POTC-3505	COVER ONLY FOR POT-3309, POT-3406 & POT-3202

## SIZZLING PLATTERS AND UNDERLINERS

ALUMINUM SIZZLING PLATTERS AND WOOD UNDERLINERS. SOLD SEPARATELY.



PL-1280	10" ALUMINUM PLATTER
PL-1281	11" ALUMINUM PLATTER
PL-1282	12" ALUMINUM PLATTER
PL-1283	10" UNDERLINER FOR PL-1280
PL-1284	11" UNDERLINER FOR PL-1281
PL-1285	12" UNDERLINER FOR PL-1282



## BAIN MARIE POTS (MIRROR FINISH STAINLESS STEEL)

COVERS ARE SOLD SEPARATELY, POTS AND COVERS SOLD SEPARATELY.



### STOCK POT

POT-48860	1 1/4 QT., 5" x 6"
POT-48861	2 QT., 5 3/4" x 7"
POT-48863	3 1/2 QT., 7 1/4" x 7"
POT-48864	4 1/4 QT., 7 1/4" x 7 3/4"
POT-48865	6 QT., 8" x 8 3/4"
POT-48866	8 1/4 QT., 9" x 9 3/4"

### POT COVER

POTC-48860	COVER FOR POT-48860
POTC-48861	COVER FOR POT-48861
POTC-48863	COVER FOR POT-48863
POTC-48864	COVER FOR POT-48864
POTC-48865	COVER FOR POT-48865

## SAUCE PAN WITH COVER (STAINLESS STEEL)

HEAVY DUTY. INDUCTION READY. NSF LISTED.



PAN-1925	2 QT.	6 3/8" x 3 3/4"
PAN-1926	3.5 QT.	8" x 4 1/4"
PAN-1927	4.5 QT.	8" x 5 1/2"
PAN-1928	6 QT.	9 1/2" x 5"
PAN-1930	7.5 QT. WITH HELP HANDLE	9 1/2" x 6 1/8"
PAN-1931	10 QT. WITH HELP HANDLE	11" x 6 1/8"



## TAPERED SAUCE PANS (ALUMINUM)

HEAVYWEIGHT. COVERS SOLD SEPARATELY. NSF LISTED. HAND WASH.



### STOCK POT

PAN-4861	1 1/2 QT. POT, 5 3/4" x 3 5/8"
PAN-4862	2 1/2 QT. POT, 7 3/4" x 4 1/8"
PAN-4863	3 3/4 QT. POT, 9" x 4 1/4"
PAN-4864	5 QT. POT, 9 3/4" x 5 1/8"

### POT COVER

POTC-4861	COVER FOR POT-4861
POTC-4862	COVER FOR POT-4862
POTC-4863	COVER FOR POT-4863
POTC-4864	COVER FOR POT-4864

## FRY PAN (STAINLESS STEEL)

HEAVY DUTY. INDUCTION READY. NSF LISTED.



PAN-1932	8" DIA.	8" x 1 1/2"
PAN-1933	9 1/2" DIA.	9 1/2" x 1 3/4"
PAN-1934	11" DIA.	11" x 2"
PAN-1935	12" DIA. WITH HELP HANDLE	12 1/2" x 2"
PAN-1936	14" DIA. WITH HELP HANDLE	14 1/4" x 2 1/2"

## FRY PAN, NON - STICK (STAINLESS STEEL)

EXCALIBUR® NON-STICK COATING. INDUCTION READY. NSF LISTED



PAN-1937	8" DIA.	8" x 1 1/2"
PAN-1938	9 1/2" DIA.	9 1/2" x 1 3/4"
PAN-1939	11" DIA.	11" x 2"
PAN-1940	12" DIA. WITH HELP HANDLE	12 1/2" x 2"
PAN-1941	14" DIA. WITH HELP HANDLE	14 1/4" x 2 1/2"

## DOUBLE BOILERS WITH COVER

INDUCTION READY. TRI-PLY BOTTOM.



POT-1942	8 QT.	9 1/2" x 6 3/4" x 7 1/2"
POT-1943	12 QT.	10 1/4" x 8 1/2" x 9 3/8"
POT-1944	16 QT.	11" x 9 5/8" x 10 1/2"
POT-1946	20 QT.	11 7/8" x 10 5/8" x 11 1/2"

## PERFORATED STEAMER/PASTA WITH COVERS

INDUCTION READY. TRI-PLY BOTTOM.



POT-1947	8 QT.	9 1/2" x 6 3/4" x 7 1/2"
POT-1948	12 QT.	10 1/4" x 8 1/2" x 9 3/8"
POT-1949	16 QT.	11" x 9 5/8" x 10 1/2"
POT-1950	20 QT.	11 7/8" x 10 5/8" x 11 1/2"

## PANS (ALUMINUM)

HEAVYWEIGHT. HAND WASH. NSF LISTED.



FRY-48806	7 1/2" NON STICK
FRY-48807	7 1/2" FRY PAN
FRY-48808	8 1/2" NON STICK
FRY-48809	8 1/2" FRY PAN
FRY-48810	10 3/8" NON STICK
FRY-48811	10 3/8" FRY PAN
FRY-48812	12 5/8" NON STICK
FRY-48813	12 5/8" FRY PAN
FRY-48814	14 9/16" NON STICK
FRY-48815	14 9/16" FRY PAN

## STEAMER BASKETS (ALUMINUM)

HEAVY WEIGHT.



SBSK-4721	20 QT.
SBSK-4741	40 QT.
SBSK-4761	60 QT.
SBSK-4781	80 QT.

## COOL HANDLE SLEEVES

SILICONE COOL SLEEVES WITHSTAND HEAT UP TO 400°F.



HAN-467	SMALL
HAN-469	MEDIUM
HAN-470	LARGE

## BRAZIER WITH HANDLES (ALUMINUM)

HEAVY DUTY. NSF LISTED. HAND WASH. POTS AND COVERS SOLD SEPARATELY.



POT-3200	15 QT.	14 3/8" DIA. x 5 3/4" DEPTH
POT-3201	18 QT.	16 3/8" DIA. x 5 1/2" DEPTH
POT-3202	24 QT.	18 3/8" DIA. x 5 3/4" DEPTH

# KITCHENWARE



**MEASURING CUPS (POLYCARBONATE)**  
POLYCARBONATE CONSTRUCTION RESISTS BREAKING AND CHIPPING, MOLDED ONE-PIECE CONSTRUCTION. DISHWASHER SAFE.

- MC-400 1 CUP
- MC-401 1 PINT
- MC-402 1 QT.
- MC-403 2 QT.
- MC-404 4 QT.
- MC-405 5 PIECE SET, INCLUDES:  
1 CUP, 1 PINT, 1 QT., 2 QT., 4 QT.



**MEASURING SPOONS**  
4 PIECE: 1/4 TEASPOON, 1/2 TEASPOON, 1 TEASPOON, 1 TABLESPOON.

- BK-400 4 PC SET
- BK-401 DELUXE 4 PC SET



AC-SQG-1

AC-SQG-4

**GRATERS (STAINLESS)**

PERFECT FOR FRESHLY GRATED CHEESES, VEGETABLES, SPICES AND MORE.

- AC-SQG-1 4" x 3" x 9" TAPERED
- AC-SQG-4 9" x 4" BOX



**GRATERS WITH COVER - 5 SLIDED GRATER**

THIS GRATER COMES WITH A COVER AND FEATURE A STAINLESS STEEL BLADE, A BLACK SOFT GRIP HANDLE, AND SUPERIOR ANTI-CORROSION AND DURABILITY PROPERTIES THAN OTHERS. DISHWASHER SAFE.

GRT-109



**MEASURING CUPS (STAINLESS)**

4 PIECE SET: 1/4 CUP, 1/3 CUP, 1/2 CUP, 1 CUP.

BK-402



**MEASURING CUPS (ALUMINUM)**

- MC-300 1/2 QT.
- MC-301 1 QT.
- MC-302 2 QT.
- MC-303 4 QT.



**CHEESE SERVER (18/8 STAINLESS)**  
HIGH POLISHED, CHEESE SERVER HAS A SLOTTED LID. AC-1625 6 OZ., 4 3/8" DIA.

**ICE SCOOPS (CLEAR POLYCARBONATE)**

- AC-12356 5 OZ.
- AC-12357 10 OZ.



**UTILITY SCOOPS (STAINLESS)**

- AC-5600 2 QT.
- AC-5601 3 QT.



**ICE SCOOPS (POLYCARBONATE)**

- AC-430607 6 OZ.
- AC-433207 32 OZ.
- AC-436407 64 OZ.



**ROLLING PINS (ALUMINUM)**

3.5" CAST ALUMINUM BARREL THAT RIDES ON A BALL BEARING ROLLER.

- RP-844713 13" L.
- RP-844715 15" L.
- RP-844718 18" L.



**PIANO WIRE WHIPS (STAINLESS)**

- ACSS-1491 10" L.
- ACSS-1492 12" L.
- ACSS-1493 14" L.
- ACSS-1494 16" L.

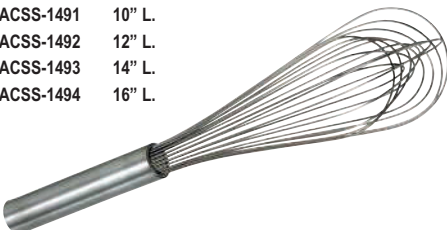

**ICE SCOOPS (STAINLESS)**

SOLD AS SET OF 12.  
ACSS-8855 4 OZ.



**ICE SCOOP (SILVERPLATE)**

AC-1054 8.5" LENGTH



**ROLLING PINS (HARDWOOD)**

MADE OF HARD ROCK MAPLE WITH A 2.75" BARREL THAT RIDES ON NYLON BALL BEARINGS.

- RP-313 13" L.
- RP-315 15" L.
- RP-318 18" L.



**PASTRY BAGS COTTON WITH PLASTIC COATING INSIDE.**

- BK-201 12"
- BK-202 14"
- BK-203 16"
- BK-204 18"
- BK-205 21"
- BK-206 24"



**PLASTIC COUPLINGS**  
PLASTIC COUPLING 2-SIZE SET. USED WITH PASTRY BAGS AND PASTRY TIPS TO CREATE BEAUTIFULLY DECORATED PASTRIES. A SET NO PASTRY CHEF CAN LIVE WITHOUT!

BK-207



**MIXING BOWLS (STAINLESS STEEL)**  
MULTI-PURPOSE MIXING BOWLS ARE GREAT FOR EVERYDAY USAGE.

- AC-1 1.5 QT.
- AC-3 3 QT.
- AC-4 4 QT.
- AC-5 5 QT.
- AC-8 8 QT.
- AC-13 13 QT.
- AC-15 16 QT.
- AC-20 20 QT.



**CHEESE GRATER (18/8 STAINLESS)**  
ROTARY GRATER WITH ONE DRUM FOR FINE CHEESE GRATING.



AC-GRTS-1  
8.34" x 4.67" x 5.48"



**CAKE DECORATING TIPS**

THESE PIECES CAKE DECORATING TIP SETS ARE MAKE FROM STAINLESS STEEL AND COMES WITH TIPS, STANDARD COUPLER, AND METAL FLOWER NAIL.

- BK-208 26 PC. CAKE DECORATING TIPS
- BK-209 52 PC. CAKE DECORATING TIPS



**COLANDERS (ALUMINUM)**

THIS LARGE ALUMINUM COLANDER IS PERFECT FOR HOLDING, STRAINING, AND WASHING LARGE AMOUNTS OF FOOD.

- CN-1235 11 QT.
- CN-1236 16 QT.

**HANDCRANK CHEESE GRATER (PLASTIC)**  
SOLD IN CASE PACKS OF 12 EACH ONLY!



HCG-950

7 3/4" L. X 2 5/8" W. X 3 1/2" H.

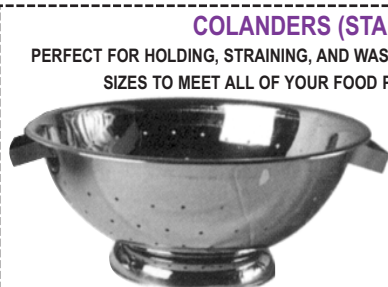

**COLANDERS (STAINLESS)**

PERFECT FOR HOLDING, STRAINING, AND WASHING. AVAILABLE IN MULTIPLE SIZES TO MEET ALL OF YOUR FOOD PREPARATION NEEDS

- CN-1231 3 QT., 10" DIA.
- CN-1232 5 QT., 12" DIA.
- CN-1233 8 QT., 14" DIA.
- CN-1234 14 QT., 16.5" DIA.

**KITCHEN SHEARS**  
KNV-1254



# KITCHENWARE & CUTLERY HOLDERS

CB-1206

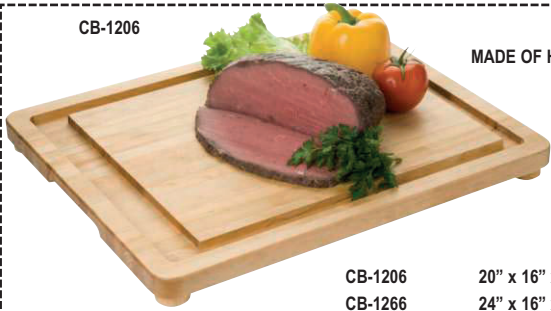

CB-1206  
CB-1266

**CARVING BOARD**  
MADE OF HARD BIRCH FOR DURABILITY. INTEGRAL CHANNEL CATCHES MEAT DROPPINGS.

20" x 16" x 1"  
24" x 16" x 1.25"

CARVING BOARD WITH WOOD LEGS, NON-SKID RUBBER BOTTOMS  
CARVING BOARD

CB-1266

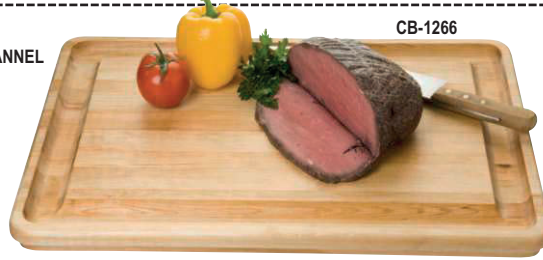

**CAN OPENER**

THIS TABLE MOUNTED CAN OPENER CAN BE MOUNTED ON ANY TABLE OR COUNTERTOP, MAKING IT PERFECT FOR BUSY KITCHENS OR TRAVELING CHEFS.



AC-56060



**CUTTING BOARD HOLDER (WIRE)**  
CB-1467 HOLDS 6 BOARDS

**COLORED CUTTING BOARDS (POLYCARBONATE)**



CB-1468	12" x 18" x 1/2" H.	BROWN
CB-1469	12" x 18" x 1/2" H.	BLUE
CB-1470	12" x 18" x 1/2" H.	GREEN
CB-1471	12" x 18" x 1/2" H.	RED
CB-1472	12" x 18" x 1/2" H.	YELLOW
CB-1473	15" x 20" x 1/2" H.	BROWN
CB-1474	15" x 20" x 1/2" H.	BLUE
CB-1475	15" x 20" x 1/2" H.	GREEN
CB-1476	15" x 20" x 1/2" H.	RED
CB-1477	15" x 20" x 1/2" H.	YELLOW
CB-1478	18" x 24" x 1/2" H.	BROWN
CB-1479	18" x 24" x 1/2" H.	BLUE
CB-1480	18" x 24" x 1/2" H.	GREEN
CB-1481	18" x 24" x 1/2" H.	RED
CB-1482	18" x 24" x 1/2" H.	YELLOW



**UTILITY BOARDS**

MADE FROM NORTHERN HARD BIRCH FOR DURABILITY.

CD-301	14" x 10" x 3/4"	RECTANGULAR
CD-303	20" x 14" x 3/4"	RECTANGULAR

**BREAD BOARD CHEESE SERVING BOARD (WOOD)**

CB-2100 12" x 5" x 3/4"



**WHITE GROOVED CUTTING BOARDS**

MADE OF POLYETHYLENE, A THICKER AND MORE DURABLE FORM OF PLASTIC.



AC-CBI-1218	12" x 18" x 1/2"
AC-CBI-1520	15" x 20" x 1/2"
AC-CBI-1824	18" x 24" x 1/2"



**CUTTING BOARD**

THIS BOARD IS MADE OF OAK AND HAS A DOUBLE SIDED INLAY FOR TWO THICKNESSES OF 1/4" OR 3/8". THE STAINLESS STEEL KNIFE ALLOWS FOR SLICING MEATS OR VEGETABLES WITH EASE. THE SET ALSO INCLUDES 1 OUNCE OF CURE AND SEASONINGS FOR 5 POUNDS OF MEAT AND SEASONINGS FOR 5 POUNDS OF MEAT.

JB-8372 JERKY BOARD AND KNIFE SET

**CUTTING BOARDS (POLYETHYLENE)**  
TRADITIONAL WHITE CUTTING BOARDS.

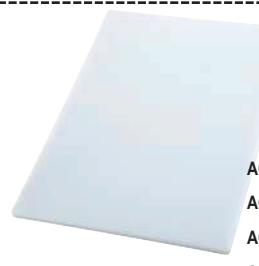

AC-4436	6" x 9" x 1/2" H.
AC-4437	12" x 18" x 1/2" H.
AC-4438	15" x 20" x 1/2" H.
AC-4439	18" x 24" x 1/2" H.

**CUTTING BOARDS (WOOD)**

EXCELLENT VALUE CUTTING BOARD AND THE PERFECT COMPANION IN THE KITCHEN.

CB-1500	12" x 18" x 1.75" H.
CB-1501	15" x 20" x 1.75" H.
CB-1502	18" x 24" x 1.75" H.
CB-1503	18" x 30" x 1.75" H.



**WALNUT FLATWARE CADDIES**

THESE FLATWARE CADDIES HAVE A SIMPLE YET ELEGANT WAY TO DISPLAY OR STORE YOUR FLATWARE. THE CADDY COMES COMPLETE WITH THREE REMOVABLE PLASTIC INSERTS TO MAKE RESTOCKING A BREEZE. YOU CAN CHOOSE FROM BRASS OR CHROME ACCENTS.

FTC-3700	WALNUT FLATWARE CADDY WITH BRASS ACCENT
FTC-3701	WALNUT FLATWARE CADDY WITH CHROME ACCENT
FTC-3715	MADERA FLATWARE CADDY, 9" W. X 6" D. X 5 1/4" H.
FTC-3720	GALVANIZED FLATWARE CADDY, 10" W. X 6" D. X 6" H.

**CYLINDER TRANSPORT RACK (STAINLESS)**

HEAVY DUTY, HOLDS 6 CYLINDERS.

CYLINDERS SOLD SEPARATELY.

AC-1932	CYLINDER RACK: 15" x 10" x 11 1/8".
AC-1427	STAINLESS CYLINDER ONLY



**WOOD CUTLERY HOLDERS WITH CHALKBOARD**

THE CHALKBOARD OFFERS EASY LABELING ALONG WITH HEIGHT TO ANY FOOD SETTING AND THE CHALK IS INCLUDED. ALL BUT RR-208 ARE MADE OF ECO-FRIENDLY BAMBOO.

RR-206	ROUND 5" DIA. X 7" H. WOOD
RR-207	SQUARE 4" X 6" H. WOOD
RR-208	ROUND 5" DIA. X 7" TEAK WITHOUT CHALKBOARD



**FLATWARE HOLDER WITH 4 DIVIDER INSERT (18/10 STAINLESS)**

IT MADE OF 18/10 STAINLESS STEEL WITH BLACK ACCENTED STAINLESS STEEL.

CRT-427  
6.25" SQUARE X 4.75" H.

**FLATWARE CYLINDER HOLDERS (STAINLESS STEEL)**

CYLINDERS SOLD SEPARATELY.



AC-1428	4 SECTIONS CYLINDER HOLDER	STAINLESS
AC-1465	6 SECTIONS CYLINDER HOLDER	STAINLESS
AC-3461	PERFORATED CYLINDER	PLASTIC



**BRICK CADDY (STAINLESS STEEL)**

THIS ITEMS HAS A UNIQUE BRICK PATTERN AND IS MADE FROM STAINLESS STEEL FOR DURABILITY.

CD-7300  
10.75" X 4.5" X 7.25"



**FLATWARE CADDY WITH SOLID BOTTOM**

THIS CADDY HAS A SIMPLE DESIGN TO MAKE IT EASY TO USE AT ANY OCCASION. IT IS CHROMEPLATED WITH A SOLID STAINLESS STEEL BOTTOM.

FTC-3500 10 1/2" X 8"



**CUTLERY BIN (BROWN PLASTIC)**

4 COMPARTMENT. INTEGRATED HANDLES.

CB-1936 20"x10"x4"





# SERVING PIECES

## SERVING PIECES (SILVERPLATE)



- AC-423 11" L. SERVING FORK, PLAIN HANDLE
- AC-424 11" L. CAKE SERVER, PLAIN HANDLE
- AC-1034 10.5" L. JUMBO TONG
- AC-1044 10.5" L. JUMBO PASTRY TONG
- AC-1052 4" L. SUGAR TONG
- AC-1053 10.5" L. SANDWICH TONG
- AC-1054 8.5" L. ICE SCOOP
- AC-1260 7" L. ICE TONG
- AC-1262 7.25" L. ICE TONG
- AC-2867 11.5" L. LASAGNA SERVER, BAROQUE DESIGN
- AC-2874 6.5" L. GRAVY LADLE, BAROQUE DESIGN



## SERVING TONGS (18/8 STAINLESS) HEAVY DUTY.

- ACSS-73013 10" LENGTH. ALL PURPOSE SCISSOR TONG
- ACSS-73014 10" LENGTH. SALAD SCISSOR TONG
- ACSS-73015 10" LENGTH. PASTRY TONG

## SERVING PIECES (STAINLESS)

SOLD IN CASE PACKS OF 12 ONLY!



- ACSS-781 11.75" L. SOLID SPOON
- ACSS-782 11.75" L. SLOTTED SPOON
- ACSS-783 11.75" L. NOTCHED SALAD SPOON
- ACSS-784 4 OZ., 12.75" L. LADLE
- ACSS-785 10.75" L. PASTRY SERVER
- ACSS-786 11.25" L. PIE SERVER
- ACSS-787 10.5" L. COLD MEAT FORK
- ACSS-792 9" L. WAVE EDGE BLADE CAKE KNIFE

## SPAGHETTI SERVER (STAINLESS)

- AC-91300 9" L.
- AC-91301 13" L.



## BAROQUE SERVING SPOON (NICKELPLATED)

- AC-15302 12.75" L.



## SERVING FORKS & SPOONS (18/10 STAINLESS STEEL)

SOLD IN CASE PACK OF DOZEN.



- |           |                |                |
|-----------|----------------|----------------|
| FL-16800  | 8.5" L. SPOON  | STAINLESS      |
| FL-16801  | 8.5" L. FORK   | STAINLESS      |
| FL-16802  | 11.5" L. SPOON | STAINLESS      |
| FL-16803  | 11.5" L. FORK  | STAINLESS      |
| FLG-16800 | 8.5" L. SPOON  | BRUSHED GOLD   |
| FLG-16801 | 8.5" L. FORK   | BRUSHED GOLD   |
| FLG-16802 | 11.5" L. SPOON | BRUSHED GOLD   |
| FLG-16803 | 11.5" L. FORK  | BRUSHED GOLD   |
| FLC-16800 | 8.5" L. SPOON  | BRUSHED COPPER |
| FLC-16801 | 8.5" L. FORK   | BRUSHED COPPER |
| FLC-16802 | 11.5" L. SPOON | BRUSHED COPPER |
| FLC-16803 | 11.5" L. FORK  | BRUSHED COPPER |

## SALAD TONGS (STAINLESS)

THESE STAINLESS STEEL TONGS WORK GREAT WITH LETTUCE, PASTA, AND VEGETABLE SALADS.



- ACSS-1026 3-TINE TONG, SPOON/FORK
- ACSS-1027 TONG, SPOON, SPATULA

## MATTE PLATING/SERVING SPOONS (18/8 STAINLESS STEEL)

THESE PLATING/SERVING SPOONS ARE COATED TO ENSURE A LONG PRODUCT LIFE. THEY HAVE DUAL MICRO-SERRATIONS FOR BETTER STABILITY AND OPTIMAL CONTROL. THE MATTE SATIN FINISH IS IDEAL TO HIDE WEAR. SOLD IN CASE PACKS ONLY.



- |           |   |                  |
|-----------|---|------------------|
| FLB-3500  | MATTE BLACK 9" L. SOLID SPOON           | <b>CASE PACK</b> |
| FLB-3501  | MATTE BLACK 7 7/8" L. SOLID SPOON       | <b>12 EACH</b>   |
| FLB-3502  | MATTE BLACK 9" L. SLOTTED SPOON         | <b>12 EACH</b>   |
| FLB-3503  | MATTE BLACK 7 7/8" L. SLOTTED SPOON     | <b>12 EACH</b>   |
| FLRG-3500 | MATTE ROSE GOLD 9" L. SOLID SPOON       | <b>12 EACH</b>   |
| FLRG-3501 | MATTE ROSE GOLD 7 7/8" L. SOLID SPOON   | <b>12 EACH</b>   |
| FLRG-3502 | MATTE ROSE GOLD 9" L. SLOTTED SPOON     | <b>12 EACH</b>   |
| FLRG-3503 | MATTE ROSE GOLD 7 7/8" L. SLOTTED SPOON | <b>12 EACH</b>   |

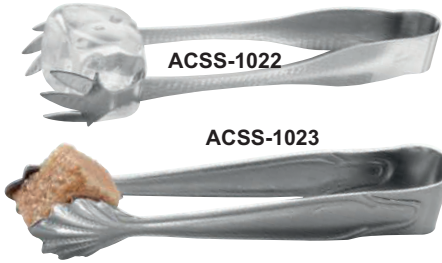

## SUGAR AND ICE TONGS (STAINLESS)

SOLD IN CASE PACK ONE DOZEN!

- ACSS-1022 6.5" L. ICE TONG (HAMMERED FINISH)
- ACSS-1023 4" L. SUGAR TONG



## SPRING

## HEAVY DUTY TONGS

SOLD IN CASE PACKS ONLY!

- |         |        |        |                  |
|---------|--------|--------|------------------|
| AC-4230 | 6" L.  | POM    | <b>CASE PACK</b> |
| AC-4231 | 9" L.  | POM    | <b>1 EACH</b>    |
| AC-4235 | 9" L.  | SPRING | <b>1 DOZ.</b>    |
| AC-4236 | 12" L. | SPRING | <b>1 EACH</b>    |
| AC-4237 | 16" L. | SPRING | <b>1 EACH</b>    |

## OVAL SALAD TONG (STAINLESS)



- ACSS-850 7.75" L.

## STAR ICE TONG (STAINLESS STEEL)



- AC-2435 7" L.

## SCALLOPED TONG (18/8 STAINLESS) HEAVY DUTY



- AC-17029 10.5" L.

# SERVING PIECES

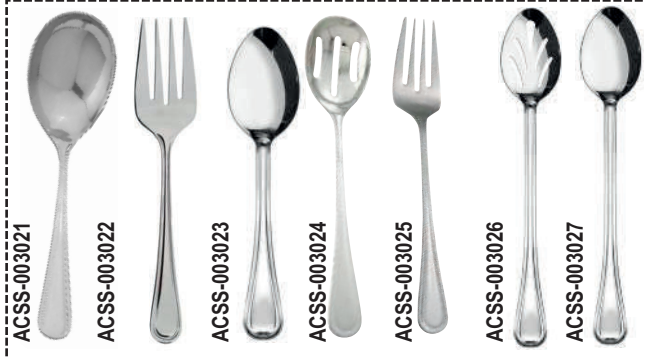

**SHANGARILA SERVING PIECES (STAINLESS)**  
SOLD IN CASE PACK OF 1 DOZEN.

ACSS-003021	8 3/4"	BOWL SERVING SPOON
ACSS-003022	9"	COLD MEAT FORK
ACSS-003023	11 1/2"	SOLID SPOON
ACSS-003024	11 1/2"	BANQUET SLOTTED SPOON
ACSS-003025	11 3/4"	BANQUET FORK
ACSS-003026	13"	SLOTTED SPOON
ACSS-003027	11 1/2"	SOLID SPOON



**SALAD TONG (STAINLESS)**  
AC-4285 10" L.



**SERVING TONG (STAINLESS)**  
EXTRA HEAVY. SOLID & NOTCHED OPPOSING GRIPS.  
AC-599 12" L.



**SERVING PIECES (GOLDPLATE)**  
ACG-86200 7" L. ICE TONG  
ACG-86201 4.5" L. SUGAR TONG

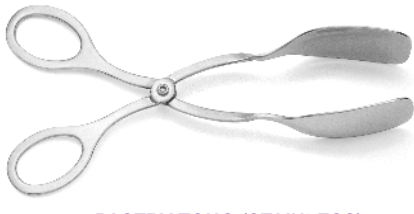

**PASTRY TONG (STAINLESS)**  
AC-4286 7" LENTH  
AC-4287 9" LENTH



**PUNCH LADLE (STAINLESS)**  
AC-72589 12" L.



ACG-86201



**ARIA SERVING PIECES (18/8 STAINLESS)**  
HEAVY DUTY, POLISHED. ONE PIECE, HOLLOW HANDLE CONSTRUCTION. DISHWASHER SAFE.

ACSS-609001	12"	SOLID SPOON
ACSS-609002	12"	SLOTTED SPOON
ACSS-609003	11 1/2"	NOTCHED SPOON
ACSS-609005	10 3/4"	COLD MEAT FORK
ACSS-609006	11 3/4"	WIDE PIE SERVER
ACSS-609007	10 7/8"	NARROW PASTRY SERVER
ACSS-609009	10"	SOLID SPOON
ACSS-609013	6"	SALAD TONG
ACSS-609014	9"	SALAD TONG
ACSS-609015	9 1/2", 1 OZ.	OVAL BOWL LADLE
ACSS-609016	13 1/2", 10 OZ.	OVAL BOWL LADLE
ACSS-609017	9 1/4"	SOLID SPOON



**SERVING PIECES (STAINLESS STEEL)**  
ACSS-1034 10.5" L. TONG  
ACSS-1044 10.5" L. PASTRY TONG  
ACSS-1053 10.5" L. SANDWICH TONG

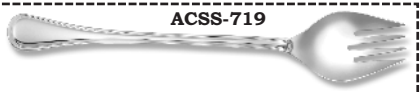

ACSS-719



ACSS-720



ACSS-723



ACSS-724



ACSS-722



**WOODEN SPOONS**  
WS-1274 12" L.  
WS-1275 14" L.  
WS-1276 16" L.  
WS-1277 18" L.



**EXTRA LONG SPOONS (STAINLESS)**  
HEAVY DUTY! EXTRA LONG HANDLE SPOONS, GREAT FOR BIG POTS  
AC-3445 18" L. SOLID  
AC-3446 21" L. SOLID  
AC-3447 18" L. SLOTTED  
AC-3448 18" L. PERFORATED



**BASTING SPOONS**  
WITH BLACK BAKE LITE HANDLES.  
AC-4630 11" L. SOLID  
AC-4631 13" L. SOLID  
AC-4632 15" L. SOLID  
AC-4633 11" L. SLOTTED  
AC-4634 13" L. SLOTTED  
AC-4635 15" L. SLOTTED  
AC-4636 11" L. PERFORATED  
AC-4637 13" L. PERFORATED  
AC-4638 15" L. PERFORATED



**BUFFET TONGS (18/8 STAINLESS)**  
HEAVY DUTY, MIRROR POLISHED FINISH.  
ACSS-607691 7" L. ICE TONG  
ACSS-607693 9" L. SALAD TONG

**BUFFETWARE (18/10 STAINLESS)**  
HEAVY DUTY, MIRROR FINISH, AND LONG HANDLES.  
ACSS-719 13.25" L. SERVING FORK  
ACSS-720 13.25" L. LADLE DOUBLE SIDE SPOUT  
ACSS-722 6" L. CLAW ICE TONG  
ACSS-723 6" L. GRABBER TONG  
ACSS-724 8.75" L. SALAD TONG



**SERVING PIECES (18/10 STAINLESS STEEL)**  
SOLD IN CASE PACKS OF 12 EACH ONLY!

ACSS-120	8.5" L., 3.25" OPENING	18/10 SS ICE TONG
ACSS-121	8" L.	18/10 SS SERVING TONG
ACSS-122	9" L.	18/10 SS PASTRY TONG TONG
ACSS-123	9" L.	18/10 SS SALAD SCISSOR TONG



**PASTRY TONG (STAINLESS)**  
ACSS-994 8" L.



**SPAGHETTI TONG (STAINLESS)**  
SEVEN TIPS PER SIDE.  
SOLD IN CASE PACKS OF 1 DOZEN ONLY!  
ACSS-1024 8" LENGTH

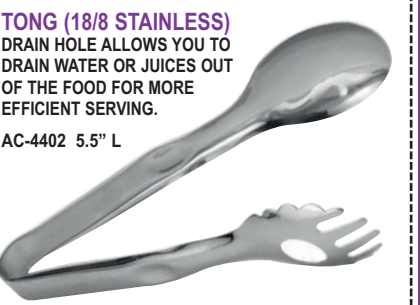

**GRAPEFRUIT SPOON (STAINLESS)**  
THIS HEAVY WEIGHT GRAPEFRUIT SPOON. THE SERATED EDGE CUTS EASILY INTO ANY CITRUS FRUIT.  
SOLD BY THE DOZEN ONLY.  
GSP-600 6 1/4"

**SERVING TONGS**  
HEAVYWEIGHT. SOLD IN CASE PACK OF 12 EACH.  
ACSS-6999 8" L. 18/10 STAINLESS  
ACSP-6999 8" L. SILVERPLATE  
ACSS-7000 12" L. 18/10 STAINLESS  
ACSP-7000 12" L. SILVERPLATE

**BAGUETTE DESIGN SERVING SPOON (SILVERPLATE)**  
AC-425 13" L.

# SERVING PIECES

## SERVING PIECES (SILVERPLATE/STAINLESS) HEAVY, DURABLE QUALITY.

ACSS-6685	10"	SHELL BREAD TONG	STAINLESS
ACSS-9541	10"	SALAD SCISSOR TONG	STAINLESS
ACSS-9548	10"	SCALLOPED EDGE SERVING TONG	STAINLESS
ACSS-9553	11" L., 1 OZ.	SPOUT LADLE FOR GRAVY	STAINLESS
ACSS-9554	7"	ICE TONG	STAINLESS
ACSP-6685	10"	SCALLOPED SHELL BREAD TONG,	SILVERPLATE
ACSP-8541	10"	SALAD SCISSOR TONG	SILVERPLATE
ACSP-8548	10"	SCALLOPED EDGE SERVING TONG	SILVERPLATE
ACSP-8553	11" L., 1 OZ.	SPOUT LADLE FOR GRAVY	SILVERPLATE
ACSP-8554	7"	ICE TONG	SILVERPLATE



ACSS-6687  
ACSS-6688  
ACSS-6689  
ACSS-6690  
ACSS-6691  
ACSS-6693  
ACSS-6694



ACSS-6685  
ACSP-6685  
ACSS-9541  
ACSP-8541  
ACSS-9548  
ACSP-8548  
ACSS-9553  
ACSP-8553  
ACSS-9554  
ACSP-8554

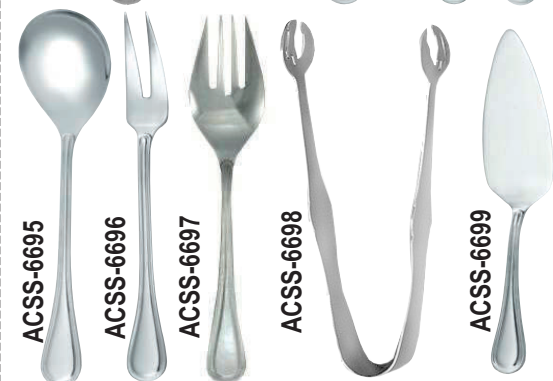

ACSS-6695  
ACSS-6696  
ACSS-6697  
ACSS-6698  
ACSS-6699



AC-HM8TNG  
AC-HM11CMF  
AC-HM11FK  
AC-HM12PIE  
AC-HM12PAS  
AC-HM14KN



**SALAD TONGS (STAINLESS)**  
SOLD CASE PACK OF 6.

ACSS-5200	10" L.	DOUBLE SPOON	MIRROR FINISH
ACSS-5201	10" L.	FORK & SPOON	SATIN FINISH

### ULTRA BUFFETWARE (18/10 STAINLESS STEEL) 18/10 STAINLESS STEEL, HEAVY GAUGE.

ACSS-6687	11" L. CARVING KNIFE
ACSS-6688	9.75" L. SLOTTED SPOON
ACSS-6689	0.75 OZ., 6" L. GRAVY LADLE
ACSS-6690	10.5" L. DEEP BOWL SPOON
ACSS-6691	4 OZ., 11.75" L. SOUP LADLE
ACSS-6693	13" L. SPOON
ACSS-6694	13" L. SLOTTED SPOON
ACSS-6695	9.5" L. WIDE BOWL SPOON
ACSS-6696	10.5" L. MEAT FORK
ACSS-6697	9 1/16" L. FRENCH FISH FORK
ACSS-6698	8" L. SERVING TONG
ACSS-6699	9.5" L. PASTRY SERVER



ACSS-6690GP  
ACSS-6691GP  
ACSS-6695GP  
ACSS-6696GP  
ACSS-6699GP

11" L. CARVING KNIFE	ACSS-6687SP
10.5" L. DEEP BOWL SPOON	ACSS-6690SP
11.75" L., 4 OZ. SOUP LADLE	ACSS-6691SP
13" L. LONG HANDLED SPOON	ACSS-6693SP
13" L. LONG HANDLED SLOTTED SPOON	ACSS-6694SP
9.5" L. WIDE BOWL SPOON	ACSS-6695SP
10.5" L. MEAT FORK	ACSS-6696SP
9.5" L. PASTRY SERVER	ACSS-6699SP

### SILVERPLATED

ACSS-6687GP	ACSS-6687GP
ACSS-6690GP	ACSS-6690GP
ACSS-6691GP	ACSS-6691GP
ACSS-6693GP	ACSS-6693GP
ACSS-6694GP	ACSS-6694GP
ACSS-6695GP	ACSS-6695GP
ACSS-6696GP	ACSS-6696GP
ACSS-6699GP	ACSS-6699GP

### GOLDPLATED

ACSS-6687GP	ACSS-6687GP
ACSS-6690GP	ACSS-6690GP
ACSS-6691GP	ACSS-6691GP
ACSS-6693GP	ACSS-6693GP
ACSS-6694GP	ACSS-6694GP
ACSS-6695GP	ACSS-6695GP
ACSS-6696GP	ACSS-6696GP
ACSS-6699GP	ACSS-6699GP

### MIRAGE BUFFET WARE (18/8 STAINLESS) HAMMERED DESIGN.

AC-HM10SPO	10" L.	SOLID SPOON
AC-HM11CMF	11" L.	COLD MEAT FORK
AC-HM11FK	11" L.	TWO TINED FORK
AC-HM12NOT	12" L.	NOTCHED SPOON
AC-HM12PAS	12" L.	PASTRY SERVER
AC-HM12PIE	12" L.	PIE SERVER
AC-HM12SL	12" L.	SLOTTED SPOON
AC-HM12SOL	12" L.	SOLID SPOON
AC-HM14KN	14" L.	SERRATED KNIFE
AC-HM1LAD	1 OZ.	9" L. LADLE
AC-HM9SPN	9.5" L.	SPOON
AC-HM8TNG	8" L.	TONG



**SERVING SPOON (STAINLESS)**  
EXTRA HEAVY DUTY.  
CASE PACK ONE DOZEN.  
ACSS-1258

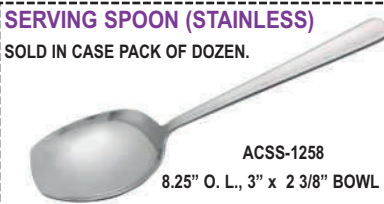

**SERVING SPOON (STAINLESS)**  
SOLD IN CASE PACK OF DOZEN.  
ACSS-1258  
8.25" O. L., 3" x 2 3/8" BOWL

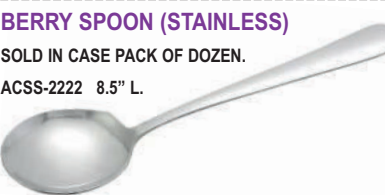

**BERRY SPOON (STAINLESS)**  
SOLD IN CASE PACK OF DOZEN.  
ACSS-2222 8.5" L.



**SLOTTED SPOON (SILVERPLATE)**  
AC-2135 12.5" L.



**SERVING PIECES (18/10 STAINLESS)**  
EXTRA HEAVYWEIGHT  
ACSS-2071 13" L. SPOON



**SERVING TONG (18/8 STAINLESS)**  
MIRROR FINISH.  
ACSS-607697 11.75" L.



AC-2438

### PASTRY TONGS (STAINLESS)

AC-2436	7.5"	SOLID WITH SHORT HANDLE
AC-2437	8.75"	SOLID WITH LONG HANDLE
AC-2438	10.5"	PERFORATED SCISSOR STYLE



**SALAD SCISSOR TONG (18/10 STAINLESS)**  
ACSS-1025 10" L.



### WESTWOOD HANDLE SERVING PIECES (NICKELPLATE)

FINISHED WITH A NON-TARNISH,  
BRIGHTLY POLISHED NICKELPLATE.

AC-1537	ICE CREAM SCOOP	8" L.
AC-1538	SPAGHETTI SERVER	10" L.
AC-1539	ICE SCOOP	8.25" L.



ACSS-9312

ACSS-9313

ACSS-9314

### BUFFET TONGS (STAINLESS) MIRROR POLISHED, ONE PIECE CONSTRUCTION. DISHWASHER SAFE!

ACSS-9312	5.75" L.	ICE
ACSS-9313	8" L.	PASTRY
ACSS-9314	9.5" L.	PASTRY



### SERVING PIECE SETS (SILVERPLATE) FLEUR-DE-LIS COLLECTION.

FL-85411	3 PC. CHEESE SET
FL-85412	4 PC. SPREADERS SET

FL-85412



### CHEESE SETS 3 PIECE SET WITH A CRYSTAL ACCENT ON THE END.

FL-87573	SILVERPLATE
FL-87574	GOLDPLATE

# SERVING PIECES

TAVOLA SERVING PIECES WITH HOLLOW COOL HANDLE (18/10 STAINLESS STEEL)  
MADE OF 18/10 STAINLESS STEEL THEN PVD COATED TO GIVE THEM BEAUTIFUL COLOR.  
THE WHOLE COLLECTION IS COMMERCIAL DISHWASHER SAFE.



STAINLESS, BLACK COLOR

- AC-94500B 14" L. FORK
- AC-94501B 6 OZ., 15" LADLE
- AC-94502B 2 OZ., 13 1/2" L. SOLID SPOON
- AC-94503B 13 1/2" L. SLOTTED SPOON
- AC-94504B 14 3/4" L. SOLID TURNER
- AC-94505B 14 3/4" L. SLOTTED TURNER
- AC-94506B 9 1/4" L. TONGS
- AC-94507B 1 OZ., 10" L. SAUCE LADLE
- AC-94508B 9 3/4" L. SOLID SPOON
- AC-94509B 9 3/4" L. SLOTTED SPOON
- AC-94510B 10 1/4" L. PASTRY SERVER
- AC-94511B 6" L. TONG



STAINLESS, BLACK MATTE COLOR

- AC-94500BM 14" L. FORK
- AC-94501BM 6 OZ., 15" LADLE
- AC-94502BM 2 OZ., 13 1/2" L. SOLID SPOON
- AC-94503BM 13 1/2" L. SLOTTED SPOON
- AC-94504BM 14 3/4" L. SOLID TURNER
- AC-94505BM 14 3/4" L. SLOTTED TURNER
- AC-94506BM 9 1/4" L. TONGS
- AC-94507BM 1 OZ., 10" L. SAUCE LADLE
- AC-94508BM 9 3/4" L. SOLID SPOON
- AC-94509BM 9 3/4" L. SLOTTED SPOON
- AC-94510BM 10 1/4" L. PASTRY SERVER
- AC-94511BM 6" L. TONG



HAMMERED STAINLESS, BLACK COLOR

- AC-94500HB 14" L. FORK
- AC-94501HB 6 OZ., 15" LADLE
- AC-94502HB 2 OZ., 13 1/2" L. SOLID SPOON
- AC-94503HB 13 1/2" L. SLOTTED SPOON
- AC-94504HB 14 3/4" L. SOLID TURNER
- AC-94505HB 14 3/4" L. SLOTTED TURNER
- AC-94506HB 9 1/4" L. TONGS
- AC-94507HB 1 OZ., 10" L. SAUCE LADLE
- AC-94508HB 9 3/4" L. SOLID SPOON
- AC-94509HB 9 3/4" L. SLOTTED SPOON
- AC-94510HB 10 1/4" L. PASTRY SERVER
- AC-94511HB 6" L. TONG



STAINLESS, GOLD COLOR

- AC-94500G 14" L. FORK
- AC-94501G 6 OZ., 15" LADLE
- AC-94502G 2 OZ., 13 1/2" L. SOLID SPOON
- AC-94503G 13 1/2" L. SLOTTED SPOON
- AC-94504G 14 3/4" L. SOLID TURNER
- AC-94505G 14 3/4" L. SLOTTED TURNER
- AC-94506G 9 1/4" L. TONGS
- AC-94507G 1 OZ., 10" L. SAUCE LADLE
- AC-94508G 9 3/4" L. SOLID SPOON
- AC-94509G 9 3/4" L. SLOTTED SPOON
- AC-94510G 10 1/4" L. PASTRY SERVER
- AC-94511G 6" L. TONG



STAINLESS, GOLD MATTE COLOR

- AC-94500GM 14" L. FORK
- AC-94501GM 6 OZ., 15" LADLE
- AC-94502GM 2 OZ., 13 1/2" L. SOLID SPOON
- AC-94503GM 13 1/2" L. SLOTTED SPOON
- AC-94504GM 14 3/4" L. SOLID TURNER
- AC-94505GM 14 3/4" L. SLOTTED TURNER
- AC-94506GM 9 1/4" L. TONGS
- AC-94507GM 1 OZ., 10" L. SAUCE LADLE
- AC-94508GM 9 3/4" L. SOLID SPOON
- AC-94509GM 9 3/4" L. SLOTTED SPOON
- AC-94510GM 10 1/4" L. PASTRY SERVER
- AC-94511GM 6" L. TONG



HAMMERED STAINLESS, GOLD COLOR

- AC-94500HG 14" L. FORK
- AC-94501HG 6 OZ., 15" LADLE
- AC-94502HG 2 OZ., 13 1/2" L. SOLID SPOON
- AC-94503HG 13 1/2" L. SLOTTED SPOON
- AC-94504HG 14 3/4" L. SOLID TURNER
- AC-94505HG 14 3/4" L. SLOTTED TURNER
- AC-94506HG 9 1/4" L. TONGS
- AC-94507HG 1 OZ., 10" L. SAUCE LADLE
- AC-94508HG 9 3/4" L. SOLID SPOON
- AC-94509HG 9 3/4" L. SLOTTED SPOON
- AC-94510HG 10 1/4" L. PASTRY SERVER
- AC-94511HG 6" L. TONG



STAINLESS, ROSE GOLD

- AC-94500RG 14" L. FORK
- AC-94501RG 6 OZ., 15" LADLE
- AC-94502RG 2 OZ., 13 1/2" L. SOLID SPOON
- AC-94503RG 13 1/2" L. SLOTTED SPOON
- AC-94504RG 14 3/4" L. SOLID TURNER
- AC-94505RG 14 3/4" L. SLOTTED TURNER
- AC-94506RG 9 1/4" L. TONGS
- AC-94507RG 1 OZ., 10" L. SAUCE LADLE
- AC-94508RG 9 3/4" L. SOLID SPOON
- AC-94509RG 9 3/4" L. SLOTTED SPOON
- AC-94510RG 10 1/4" L. PASTRY SERVER
- AC-94511RG 6" L. TONG



STAINLESS, ROSE GOLD MATTE

- AC-94500RGM 14" L. FORK
- AC-94501RGM 6 OZ., 15" LADLE
- AC-94502RGM 2 OZ., 13 1/2" L. SOLID SPOON
- AC-94503RGM 13 1/2" L. SLOTTED SPOON
- AC-94504RGM 14 3/4" L. SOLID TURNER
- AC-94505RGM 14 3/4" L. SLOTTED TURNER
- AC-94506RGM 9 1/4" L. TONGS
- AC-94507RGM 1 OZ., 10" L. SAUCE LADLE
- AC-94508RGM 9 3/4" L. SOLID SPOON
- AC-94509RGM 9 3/4" L. SLOTTED SPOON
- AC-94510RGM 10 1/4" L. PASTRY SERVER
- AC-94511RGM 6" L. TONG



HAMMERED STAINLESS, ROSE GOLD

- AC-94500HRG 14" L. FORK
- AC-94501HRG 6 OZ., 15" LADLE
- AC-94502HRG 2 OZ., 13 1/2" L. SOLID SPOON
- AC-94503HRG 13 1/2" L. SLOTTED SPOON
- AC-94504HRG 14 3/4" L. SOLID TURNER
- AC-94505HRG 14 3/4" L. SLOTTED TURNER
- AC-94506HRG 9 1/4" L. TONGS
- AC-94507HRG 1 OZ., 10" L. SAUCE LADLE
- AC-94508HRG 9 3/4" L. SOLID SPOON
- AC-94509HRG 9 3/4" L. SLOTTED SPOON
- AC-94510HRG 10 1/4" L. PASTRY SERVER
- AC-94511HRG 6" L. TONG



# SERVING PIECES



**EVOLUTION BUFFETWARE (STAINLESS)**  
THEY ARE MADE FROM DURABLE STAINLESS STEEL.

ACSS-99500	10 7/8" L.	SALAD SPOON
ACSS-99501	11 7/8" L.	SALAD FORK
ACSS-99502	12" L.	SLOTTED SPOON
ACSS-99503	13 3/4" L.	CARVING FORK
ACSS-99504	14 3/4" L.	CARVING KNIFE
ACSS-99505	13 3/8" L.	SERVER/TURNER
ACSS-99506	14 3/4" L.	SERVING TONG
ACSS-99507	13 1/2" L.	PASTRY/CAKE SERVER
ACSS-99508	10 3/4" L.	TONG
ACSS-99509	9" L., 1 OZ.	LADLE
ACSS-99510	4 7/8" L.	MUSTARD SPADE

**BAR KNIFE**

SOLD IN CASE PACK OF 24 EACH.  
BKNV-740 7.25" L.



**PEELER/ZESTER**

SOLD IN CASE PACK OF 12 EACH.  
BKNV-741 6" L.

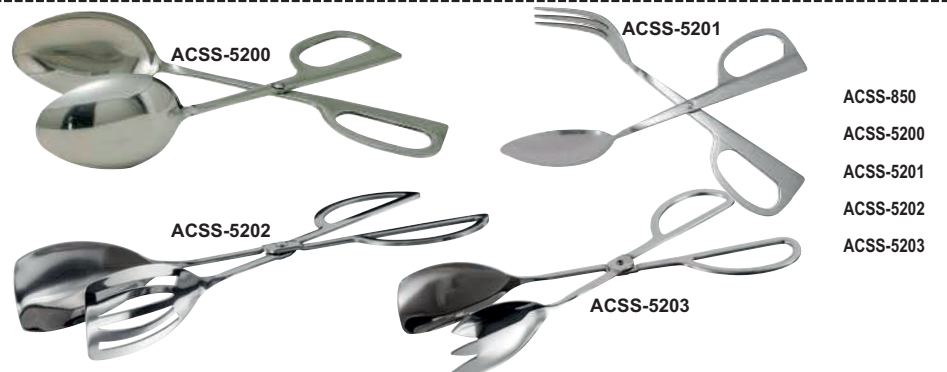

**SALAD TONGS (STAINLESS)**

ACSS-850	7.75" L.	OVAL	SATIN FINISH
ACSS-5200	10" L.	DOUBLE SPOON	MIRROR FINISH
ACSS-5201	10" L.	FORK & SPOON	SATIN FINISH
ACSS-5202	10" L.	SLOTTED & SOLID SPATULA	MIRROR FINISH
ACSS-5203	10.5" L.	SPATULA AND FORK	MIRROR FINISH

**OYSTER/CLAM KNIFE**

SOFT GRIP HANDLE NSF.  
OCK-3140 5 7/8" L.



**DOUBLE JAW LOBSTER CRACKERS**  
LIGHTWEIGHT. SOLD AS SET OF 12 ONLY!



AC-4599 6.25" L.  
ZINC ALLOY STAINLESS

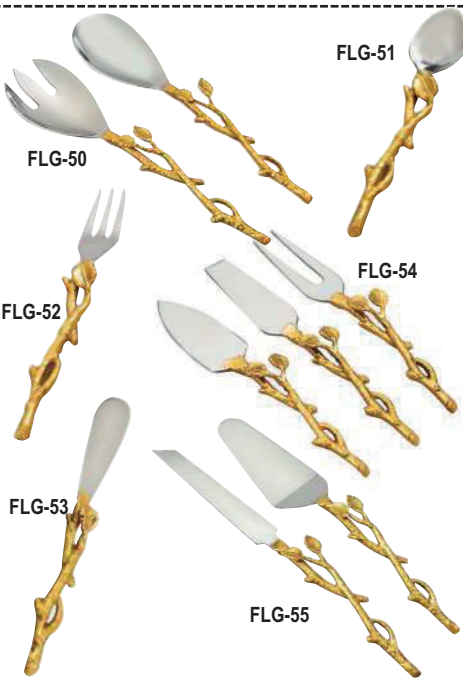

**GOLDEN VINE SERVING PIECES**

FLG-50	11.25"	2 PC. SALAD SET
FLG-51	4.5"	4 PC. SPOON SET
FLG-52	5.25"	4 PC. FORK SET
FLG-53	6"	4 PC. SPREADER SET
FLG-54	6.875"	3 PC. CHEESE SET
FLG-55	13"	2 PC. CAKE/KNIFE SET



**SCISSOR TONGS (NICKELPLATE)**

THEY ARE 10.75" LONG AND COME GIFT BOXED.

ACSS-15490	SCISSOR SALAD TONG	10.75" L.
ACSS-15491	SCISSOR SERVING TONG	10.75" L.



**COLOR PORTION CONTROLLERS**

AC-15601	2 OZ.	SOLID	RED HANDLE
AC-15602	2 OZ.	PERFORATED	RED HANDLE
AC-15603	3 OZ.	SOLID	BEIGE HANDLE
AC-15604	3 OZ.	PERFORATED	BEIGE HANDLE
AC-15605	4 OZ.	SOLID	GREEN HANDLE
AC-15606	4 OZ.	PERFORATED	GREEN HANDLE
AC-15607	6 OZ.	SOLID	BLACK HANDLE
AC-15608	6 OZ.	PERFORATED	BLACK HANDLE
AC-15609	8 OZ.	SOLID	BLUE HANDLE
AC-15610	8 OZ.	PERFORATED	BLUE HANDLE

**DOUBLE JAW LOBSTER CRACKERS (STAINLESS)**



AC-26 6"

**NUT CRACKER (CHROMEPLATE)**



AC-27 6" L.



**IDOL BUFFETWARE COLLECTION (18/10 STAINLESS)**

THE PISTOL GRIP FINGER HOLDS ENHANCE SECURE HANDLING. THEY ARE MADE FROM 18/10 STAINLESS STEEL SO THEY ARE SURE TO BE DURABLE.

ACSS-3130	10" L.	SOLID SERVING SPOON
ACSS-3131	10" L.	MEAT FORK
ACSS-3132	10" L.	WIDE BOTTOM SPOON
ACSS-3133	10" L.	PASTRY SERVER
ACSS-3134	13" L.	LONG HANDLE SPOON
ACSS-3135	13" L.	LONG HANDLE SLOTTED SPOON



**LYNDON SERVING PIECES (18/10 STAINLESS STEEL)**

ACSS-42310	2 PC. CARVING SET, 10" L. FORK & 13" L. KNIFE
ACSS-42311	CAKE KNIFE & LIFTER SET, 13" KNIFE & 11" SERVER
ACSS-42312	11" L. BUFFET FORK
ACSS-42313	11 1/2" L. PIERCED BUFFET SPOON
ACSS-42314	11 1/2" L. BUFFET SPOON
ACSS-42315	9 3/4" L. VEGETABLE SPOON
ACSS-42316	7 1/4" L. LADLE
ACSS-42317	11 1/2" LASAGNA SERVER
ACSS-42318	11" PASTA SCOOP
ACSS-42319	9" L. BAR SPOON



**IRONSTONE BUFFETWARE**

MATCHES IRONSTONE FLATWARE.

11" L.	SOLID SERVING SPOON
9.5" L.	WIDE BOTTOM SPOON
9.5"	PASTRY SERVER
13.25"	LONG HANDLE SPOON
13.25"	LONG HANDLE SLOTTED SPOON
1 OZ., 12.25" L.	SAUCE LADLE WITH SPOUT

**HAMMERED HANDLE DESIGN**

18/10 STAINLESS	SILVERPLATED	GOLDPLATED
FL-63011	FL-63011SP	FL-63011GP
FL-63012	FL-63012SP	FL-63012GP
FL-63013	FL-63013SP	FL-63013GP
FL-63014	FL-63014SP	FL-63014GP
FL-63015	FL-63015SP	FL-63015GP
FL-63016	FL-63016SP	FL-63016GP

# SERVING PIECES

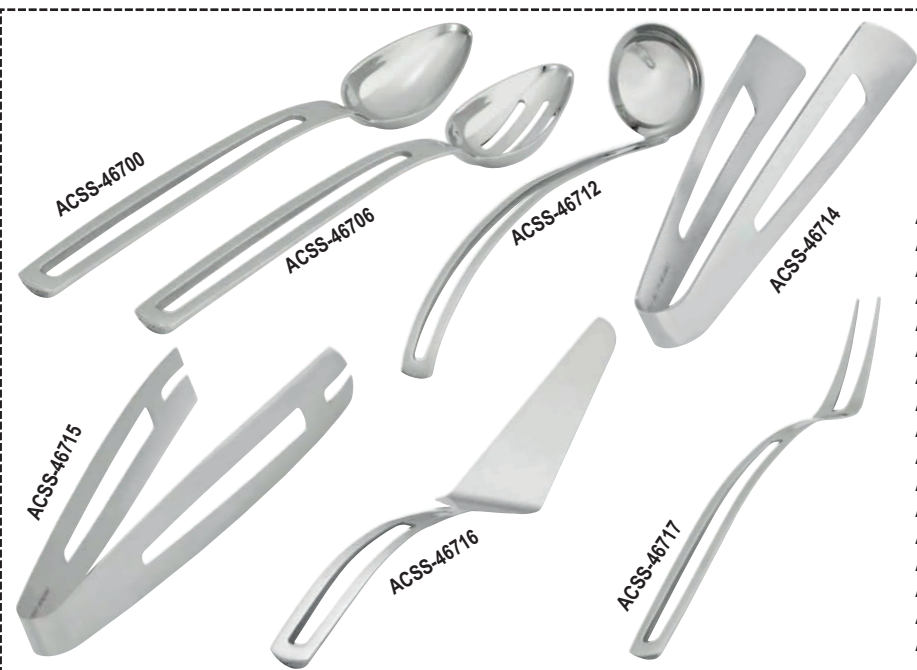

**MIRAMAR SERVING UTENSILS (STAINLESS STEEL)**  
THE ERGONOMIC DESIGN MAKE THEM COMFORTABLE TO USE. THE HIGH POLISHED HEAVY DUTY CAST STAINLESS STEEL HANDLE FEATURES AN OPEN DESIGN TO MAINTAIN A SAFE TEMPERATURE WHEN HANDLING. DISHWASHER SAFE, EASY TO CLEAN. NSF CERTIFIED.

- ACSS-46700 1/8 CUP OVAL SOLID SERVING SPOON, 10.96" L.
- ACSS-46701 1/4 CUP OVAL SOLID SERVING SPOON, 11.47" L.
- ACSS-46702 1/3 CUP OVAL SOLID SERVING SPOON, 11.843" L.
- ACSS-46703 1/2 CUP OVAL SOLID SERVING SPOON, 12.34" L.
- ACSS-46704 3/4 CUP OVAL SOLID SERVING SPOON, 12.82" L.
- ACSS-46705 1 CUP OVAL SOLID SERVING SPOON, 13.183" L.
- ACSS-46706 1/8 CUP OVAL SLOTTED SERVING SPOON, 10.96" L.
- ACSS-46707 1/4 CUP OVAL SLOTTED SERVING SPOON, 11.47" L.
- ACSS-46708 1/3 CUP OVAL SLOTTED SERVING SPOON, 11.843" L.
- ACSS-46709 1/2 CUP OVAL SLOTTED SERVING SPOON, 12.34" L.
- ACSS-46710 3/4 CUP OVAL SLOTTED SERVING SPOON, 12.82" L.
- ACSS-46711 1 CUP OVAL SLOTTED SERVING SPOON, 13.183" L.
- ACSS-46712 2 OZ. SERVING LADLE, 10.724" L.
- ACSS-46713 4 OZ. SERVING LADLE, 10.974" L.
- ACSS-46714 BREAD, PASTRY TONG, 7.928" L.
- ACSS-46715 SERVING TONG, 10" L.
- ACSS-46716 PASTRY SERVER, 11" L.
- ACSS-46717 2-TINE POT FORK, 11.5" L.

**SAUCE AND PLATING SPOONS (18/8 STAINLESS STEEL)**

- SPN-800 8" L. SAUCIER SPOON WITH TAPERED SPOUT
- SPN-801 8" L. SLANTED SOLID
- SPN-802 10" L. SLANTED SOLID
- SPN-803 8" L. SLANTED PERFORATED
- SPN-804 10" L. SLANTED PERFORATED



**NEW!**

**HAMMERED SERVING PIECES (STAINLESS)**

- SET HAS HAMMERED HANDLES. MADE FROM STAINLESS STEEL.
- ACSS-7520 11" CAKE KNIFE & LIFTER SET STAINLESS FINISH
  - ACSS-7521 10.5" SALAD SERVER SET STAINLESS FINISH
  - ACC-7520 11" CAKE KNIFE & LIFTER SET COPPER FINISH
  - ACC-7521 10.5" SALAD SERVER SET COPPER FINISH



**VINTAGE BUFFETWARE, BRONZE (HAMMERED STAINLESS STEEL)**  
DISHWASHER SAFE. SOLD IN THE CASE PACKS OF 6 ONLY. **NEW!**

- ACB-7400 SERVING TONG 9" L.
- ACB-7401 SERVING TONG 11 3/4" L.
- ACB-7402 PIE SERVER 12 1/4" L.
- ACB-7403 COLD MEAT FORK 13" L.
- ACB-7404 SLOTTED SPOON 13 1/4" L.
- ACB-7405 SOLID SPOON 13 1/4" L.
- ACB-7406 LADLE 3 1/2 OZ., 13" L.
- ACB-7407 LADLE 1 1/2 OZ., 11 1/2" L.



**VINTAGE BUFFETWARE, GOLD (HAMMERED STAINLESS STEEL)**  
DISHWASHER SAFE. SOLD IN THE CASE PACKS OF 6 ONLY. **NEW!**

- ACG-7400 SERVING TONG 9" L.
- ACG-7401 SERVING TONG 11 3/4" L.
- ACG-7402 PIE SERVER 12 1/4" L.
- ACG-7403 COLD MEAT FORK 13" L.
- ACG-7404 SLOTTED SPOON 13 1/4" L.
- ACG-7405 SOLID SPOON 13 1/4" L.
- ACG-7406 LADLE 3 1/2 OZ., 13" L.
- ACG-7407 LADLE 1 1/2 OZ., 11 1/2" L.

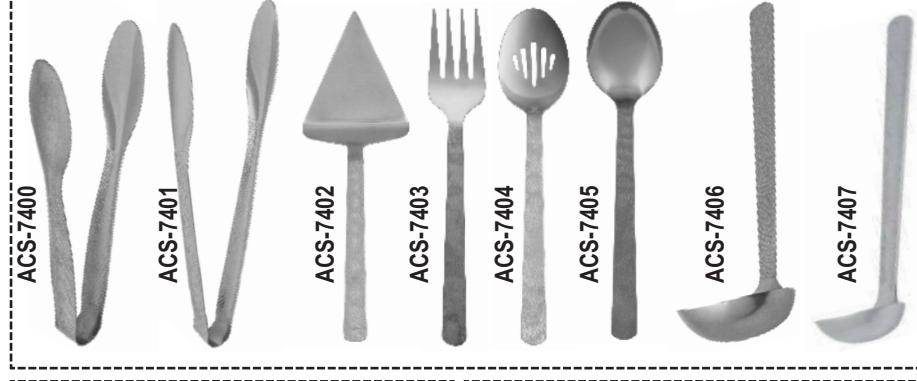

**VINTAGE BUFFETWARE, STAINLESS (HAMMERED STAINLESS STEEL)**  
DISHWASHER SAFE. SOLD IN THE CASE PACKS OF 6 ONLY. **NEW!**

- ACS-7400 SERVING TONG 9" L.
- ACS-7401 SERVING TONG 11 3/4" L.
- ACS-7402 PIE SERVER 12 1/4" L.
- ACS-7403 COLD MEAT FORK 13" L.
- ACS-7404 SLOTTED SPOON 13 1/4" L.
- ACS-7405 SOLID SPOON 13 1/4" L.
- ACS-7406 LADLE 3 1/2 OZ., 13" L.
- ACS-7407 LADLE 1 1/2 OZ., 11 1/2" L.



**BLACK NYLON COOKING TOOLS**

- AC-7851 12" L. WIDE BLADE SLOTTED SPATULA
- AC-7852 12" L. SLOTTED SPOON
- AC-7853 12" L. SOLID SPOON
- AC-7854 12" L. PRONG FORK.
- AC-7855 12" L. PASTA FORK
- AC-7856 12" L. RECTANGULAR SPATULA



**NEW!**

**SERVING TONGS (SATIN FINISH STAINLESS STEEL)**

- THESE TONGS ARE MADE FROM SATIN FINISH STAINLESS STEEL SO THEY ARE MADE TO LAST. SOLD IN THE CASE PACKS OF 2 ONLY.
- ACSS-8500 SOLID, 8 1/2" L. X 2 1/2" W. X 2 1/2" H.
  - ACSS-8501 SLOTTED, 8 1/2" L. X 2 1/2" W. X 2 1/2" H.



**3 PC BABY FEEDING SET (NICKELPLATE)**  
THE SET IS NON-TARNISH NICKELPLATED. THE FORK AND SPOON ARE 4" LONG WHILE THE LONG HANDLED SPOON IS 5.5" LONG. THE SET COMES WITH GIFT BOX.

- BFL-101 FORK & SPOON 4" L., SPOON 5.5" L.



**DISHERS/PORTIONERS (STAINLESS)**

- AC-8920 4 OZ. 2 3/4" DIA.
- AC-8921 3 3/4 OZ. 2 5/8" DIA.
- AC-8922 3 1/4 OZ. 2 1/2" DIA.
- AC-8923 2 3/4 OZ. 2 1/4" DIA.
- AC-8924 1 1/2 OZ. 2 1/8" DIA.
- AC-8925 1 3/4 OZ. 1 15/16" DIA.
- AC-8926 1 1/4 OZ. 1 7/8" DIA.
- AC-8927 7/8 OZ. 1 3/4" DIA.
- AC-8928 5/8 OZ. 1 1/2" DIA.
- AC-8929 9/16 OZ. 1 7/16" DIA.
- AC-8930 1/2 OZ. 1 3/8" DIA.
- AC-8931 3/8 OZ. 1 1/8" DIA.

# SERVING PIECES



**EZ USE BANQUET SERVERS (STAINLESS)**  
COOL GRIP HOLLOW HANDLES ARE CURVED FOR EASY USE & ENHANCED PRESENTATION.

ACSS-9450	14"	FORK
ACSS-9451	15"	LADLE
ACSS-9452	13.5"	SOLID SPOON
ACSS-9453	13.5"	SLOTTED SPOON
ACSS-9454	14.75"	SOLID TURNER
ACSS-9455	14.75"	SLOTTED TURNER



**BANQUET BUFFET SERVING UTENSILS (18/10 STAINLESS STEEL)**  
HIGH QUALITY & LOOK TO COMPLIMENT YOUR BUFFET.

ACSS-9460	9"	TONGS
ACSS-9461	12.5"	SERVING SPOON
ACSS-9462	13"	SPATULA
ACSS-9463	12.5"	SERVING FORK/MEAT
ACSS-9464	16"	SOUP LADLE



**SALAD DRESSING LADLES (18/10 STAINLESS)**

ACSS-8400-00	CREAMY ITALIAN
ACSS-8400-01	RUSSIAN
ACSS-8400-02	FRENCH
ACSS-8400-03	BLUE CHEESE
ACSS-8400-04	ITALIAN
ACSS-8400-05	HOUSE
ACSS-8400-06	BLANK
ACSS-8400-07	THOUSAND ISLAND
ACSS-8400-08	OIL & VINEGAR
ACSS-8400-09	GREEN GODDESS
ACSS-8400-10	LO-CAL
ACSS-8400-11	ROQUEFORT
ACSS-8400-12	VINAIGRETTE
ACSS-8400-13	HONEY MUSTARD
ACSS-8400-14	LITE RANCH
ACSS-8400-15	RANCH
ACSS-8400-16	CAESAR



**EVOLUTION CHEESE KNIVES (SATIN FINISH STAINLESS STEEL)**  
SOLD IN CASE PACKS OF 24 ONLY.

KNV-5500	FLAT CHEESE KNIFE	5 1/4" L.
KNV-5501	SEMI-HARD CHEESE KNIFE	5 1/4" L.
KNV-5502	HARD CHEESE KNIFE	5 1/4" L.
KNV-5503	SOFT CHEESE KNIFE & SPREADER	6 5/8" L.
KNV-5504	FORK-TIPPED HARD CHEESE KNIFE	9" L.
KNV-5505	SOFT CHEESE KNIFE	9" L.
KNV-5506	HARD CHEESE KNIFE	9" L.



**OLIVE STUFFER**  
SOLD IN CASE PACKS OF 12.  
OS-55 5 5/8" L.

**CURVED ONE PIECE LADLES (POLYCARBONATE)**

THE POLYCARBONATE MATERIAL ALLOWS THE LADLE TO WITHSTAND TEMPS FROM -40 DEGREES FAHRENHEIT TO 212 DEGREES FAHRENHEIT. SOLD IN THE CASE PACKS OF 12. NSF LISTED.

**NEW!**



ACC-800C	3/4 OZ., 8 1/2" L., CLEAR
ACC-800K	3/4 OZ., 8 1/2" L., BLACK
ACC-800R	3/4 OZ., 8 1/2" L., RED
ACC-801C	1 OZ., 13" L., CLEAR
ACC-801K	1 OZ., 13" L., BLACK
ACC-801R	1 OZ., 13" L., RED



**BLACK DISPOSABLE SERVING PIECES (POLYPROPYLENE)**

		<b>CASE PACK</b>
DP-8940	7" L. SCALLOPED	24 EA.
DP-8941	9" L. SCALLOPED	24 EA.
DP-8942	12" L. SCALLOPED	24 EA.
DP-8943	8.5" L. SERVING FORK	144 EA.
DP-8944	8.5" L. SERVING SPOON	144 EA.

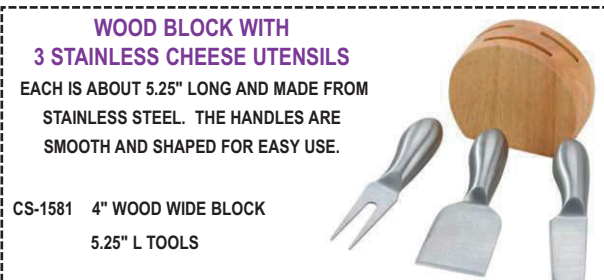

**WOOD BLOCK WITH 3 STAINLESS CHEESE UTENSILS**

EACH IS ABOUT 5.25" LONG AND MADE FROM STAINLESS STEEL. THE HANDLES ARE SMOOTH AND SHAPED FOR EASY USE.

CS-1581	4" WOOD WIDE BLOCK
	5.25" L TOOLS



**SPOON HOLDERS (STAINLESS STEEL)**

SH-50	IDOL SPOON REST, STAINLESS STEEL
SH-51	IRONSTONE HAMMERED SPOON REST, STAINLESS STEEL



**RECTANGULAR WOOD CHEESEBOARD WITH 3 STAINLESS CHEESE UTENSILS**

HOLDS THE 3 CHEESE TOOLS INSIDE. EACH TOOL IS BETWEEN 7" AND 8.5" LONG AND MADE FROM STAINLESS STEEL.

CS-1582	WOOD BOARD: 10.625" X 7.75" X 2" H.
---------	-------------------------------------



**6 PC CHEESE KNIFE SET (STAINLESS STEEL BLADE & WOOD HANDLES)**

THE SET INCLUDES KNIVES FOR HARD, SOFT, FIRM, OR CRUMBLY CHEESES.

CKS-605
---------



**ROUND WOOD CHEESEBOARD WITH 4 STAINLESS CHEESE UTENSILS**

THE WOOD BOARD HOLDS THE 4 CHEESE TOOLS INSIDE. EACH TOOL IS MADE FROM STAINLESS STEEL. THE HANDLES ARE SMOOTH AND SHAPED FOR EASY USE.

CS-1583
---------

**BUFFETWARE BOX**  
INSIDE TOP DIMENSION: 20 1/8" L. x 14 1/4" W. x 4 5/8" T.  
OUTSIDE BOTTOM DIMENSION: 18 3/4" L. x 13 1/4" W.  
BX-313 COLOR: GRAY



# SERVING PIECES



**GOLD HAMMERED HANDLE KNIFE & LIFTER SET**  
THIS GOLD KNIFE AND SERVER SET HAS A HAMMERED HANDLE DESIGN. THE SET COMES GIFT BOXED.  
ACG-3300 13" L.



**EMBRACE NICKELPLATED KNIFE & LIFTER SET (NICKELPLATE)**  
THE SET COMES GIFT BOXED.  
ACG-3301 13.5" L.



**GALAXY ROSE GOLD KNIFE & LIFTER SET**  
THIS ROSE GOLD KNIFE AND SERVER SET HAS A BEAUTIFUL STAR LIKE HANDLE DESIGN. THE SET COMES GIFT BOXED.  
ACG-3302 13" L.



**HEART SHOWER NICKELPLATE KNIFE & LIFTER SET (NICKELPLATE)**  
THIS NICKELPLATED KNIFE AND SERVER SET HAS A BEAUTIFUL HEART HANDLE DESIGN. THE SET COMES GIFT BOXED.  
ACG-3304 13" L.



**KNIFE/CAKE SET (SILVERPLATE)**  
AC-1128  
KNIFE: 12.5" L. x 2" W.  
SERVER: 11.5" L. x 3" W.



**STAINLESS STEEL CAKE KNIFE & LIFTER SET WITH CLEAR ACRYLIC CRYSTAL CUT HANDLES**  
THE SET COMES COMPLETE WITH A GIFT BOX.  
ACC-225  
KNIFE: 13 1/4" L.  
LIFTER: 11" L.



**CAKE/PIE SERVER (18/10 STAINLESS)**  
ACSS-6670 10.25" L.



**WESTWOOD CAKE SERVER (NICKELPLATE)**  
SOLD IN CASE PACK OF 6 EACH ONLY.  
AC-1534 9.75" L.

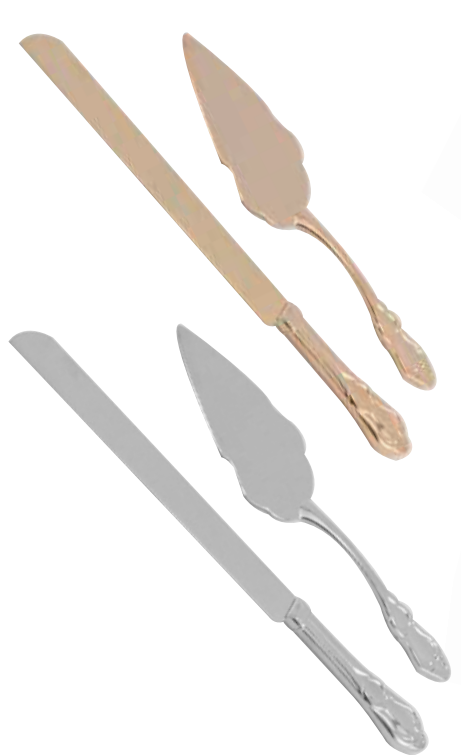

**2 PC. KNIFE AND LIFTER SET**  
CAKE KNIFE: 14.25" L. CAKE SERVER: 11.25" L.  
AC-25592 SILVERPLATE  
ACG-45592 GOLDPLATE



**2 PC. CAKE SERVER SET (SILVERPLATED)**  
AC-83616 12" L. FAUX DIAMOND ACCENTS  
AC-83636 12" L. PINK RHINESTONE ACCENTS



**KNIFE AND LIFTER SET WITH FAUX CRYSTALS**  
ACG-258  
KNIFE: 12 3/4" L.;  
SERVER: 11" L.



**KNIFE AND SERVER (SILVERPLATE)**  
AC-1011  
KNIFE: 12" L.  
SERVER: 10" L.



**CAKE KNIFE (SILVERPLATE)**  
BAROQUE DESIGN HANDLE.  
AC-102 12.5" L.



**CAKE KNIFE & SERVER SET (SILVERPLATE)**  
AC-87226



**NEW!**  
**GEOMETRIC SERVING SETS (STAINLESS STEEL WITH GOLD HANDLES)**  
ACSS-70224 12.5" L. SALAD SERVER SET  
ACSS-70225 11.5" L. CAKE SERVER SET



**2 PC STAINLESS CARVING SET IN BLACK BOX**  
THIS STAINLESS CARVING SET FEATURES A SMOOTH GRIP ON THE HANDLES OF THE FORK AND KNIFE. THE SET INCLUDES A BLACK BOX WITH SILVER HINGES THAT MEASURES 13" X 3.75" X 1.75" WHEN CLOSED  
CST-1505 12.25" L (BOX: 13" X 3.75" X 1.75")



**BABY SPOON (SILVERPLATED)**  
THE SPOON IS 5.5" LONG AND COMES WITH A GREY FLOCKED KEEPSAKE BOX.  
BFL-100 5.5" L.



**POCKET CRUMBER (ALUMINUM)**  
ALUMINUM CRUMBER WITH STAINLESS POCKET CLIP.  
AC-801 6" x 5/8" HIGH POLISH GOLD  
AC-802 6" x 5/8" HIGH POLISH SILVER  
AC-803 6" x 5/8" HIGH POLISH BLACK



# KNIVES



### PROFESSIONAL CUTLERY

SLIP RESISTANT HANDLES FEATURE DIRECT INJECTION MOLDING FOR MAXIMUM STRENGTH BETWEEN THE HANDLE AND BLADE. HANDLES MADE OF DENSE POLYPROPYLENE AND ARE DISHWASHER SAFE. NSF CERTIFIED.

KNV-46206	6"	NARROW STIFF BONING
KNV-46406	6"	CURVED BONING
KNV-46712	12"	ROAST BEEF SLICER
KNV-46908	8"	WIDE COOK'S KNIFE
KNV-46910	10"	WIDE COOK'S KNIFE
KNV-47010	10"	CIMETER KNIFE



### FULL TANG HANDLE KNIVES (STAINLESS)

FORGED BLADE, EASY GRIND. OUR PROFESSIONAL GRADE!

KNV-1252	10" BLADE	BREAD KNIFE POM HANDLE
KNV-1253	7" BLADE	BREAD KNIFE POM HANDLE
KNV-5400	18"	COOKS FOR WITH POM HANDLE
KNV-5401	7" H	HEAVY DUTY CLEAVER POM HANDLE
KNV-5402	12"	CARVING KNIFE POM HANDLE



6 PC CHEESE KNIFE SET (STAINLESS STEEL BLADE & POM HANDLES) CKS-600

### SHARPENING STEEL

AC-4190 12" LENGTH  
AC-4191 14" LENGTH



### KNIFE SHARPENER

THE SHARPENER FEATURES AN ERGONOMIC DESIGN FOR EASY HOLDING, WHILE THE SHARPENER ITSELF ENSURES PRECISION HONING.



### FORGED BLADE PROFESSIONAL CUTLERY

KNV-6200	10"	CHEF KNIFE
KNV-6201	10"	GRANDTON EDGE SLICER
KNV-6202	10"	FISH/ROAST SLICER W/ GRANDTON EDGE
KNV-6203	12"	CHEF KNIFE
KNV-6204	3.5"	PAIRING KNIFE
KNV-6205	5"	UTILITY KNIFE
KNV-6206	6"	CHEF KNIFE
KNV-6207	6"	BONING KNIFE
KNV-6208	7"	SANTOKU KNIFE
FRK-6209	7"	CARVING FORK
KNV-6210	8"	CHEF KNIFE
KNV-6211	8"	SLICER
KNV-6212	8"	BREAD KNIFE
KNV-6213	8"	OFFSET BREAD KNIFE

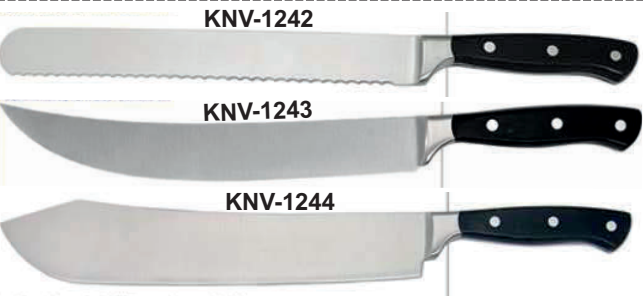

### PROFESSIONAL GRADE FORGED CUTLERY

HAND HONED EDGE. POM BLACK HANDLES. FORGED GERMAN HIGH CARBON STAINLESS STEEL.

KNV-1242	10" BREAD KNIFE
KNV-1243	11" CIMETER KNIFE
KNV-1244	11" BUTCHER KNIFE



### FULL TANG FORGED CUTLERY

THE BLADE IS MADE OF GERMAN STEEL WHILE THE BLADE HAS A SIX SPOT ADVANCED POLISHING TO ALLOW FOR A COMFORTABLE GRIP. THE POM INJECTION MOLDED HANDLE ALLOWS FOR EASE OF USE. NSF LISTED.

KNV-1260	PEELING KNIFE WITH 2 3/4" BLADE
KNV-1261	TOMATO AND CHEESE KNIFE WITH 5" BLADE
KNV-1262	FLEXIBLE FILLET KNIFE WITH 7" BLADE



### CUTLERY POUCHES (BLACK NYLON)

THIS POUCH IS AN EXCELLENT WAY TO SAFELY STORE AND TRANSPORT YOUR CUTLERY. THE POUCH HAS 10 POCKETS, ALLOWING YOU TO HOLD A RANGE OF KNIVES, AND 2 CLASPS TO KEEP EVERYTHING SECURELY INSIDE.

KNV-1250

# KNIVES



STK-8500  
9 3/4" L. CHAMBERS GAUCHO STEAK KNIFE, HH  
SOLD IN CASE PACKS OF 1 DOZEN.



STK-8501  
9 3/4" L. TUSCANY GAUCHO STEAK KNIFE, HH  
SOLD IN CASE PACKS OF 1 DOZEN.



STK-8502  
9 3/4" L. KOBE STEAK KNIFE, NO SERRATION  
SOLD IN CASE PACKS OF 1 DOZEN.



STK-8503  
10" GAUCHO STEAK KNIFE, 5" ROUNDED TIP BLADE  
SOLD IN CASE PACKS OF 1 DOZEN.



STK-8504  
9 3/4" L. MANHATTAN GAUCHO STEAK KNIFE, HH  
SOLD IN CASE PACKS OF 1 DOZEN.



STK-8505  
9 3/4" L. SCARLETT GAUCHO STEAK KNIFE, HH  
SOLD IN CASE PACKS OF 1 DOZEN.



STK-8506  
9 3/4" L. KOBE STEAK KNIFE, SERRATED BLADE  
SOLD IN CASE PACKS OF 1 DOZEN.



STK-8507  
10" L. GAUCHO STEAK KNIFE, POINTED TIP BLADE  
SOLD IN CASE PACKS OF 1 DOZEN.



STK-8508  
10" L. STEAK KNIFE WITH DARK WOOD HANDLE  
SOLD IN CASE PACKS OF 1 DOZEN.



STK-1000  
9" L. BLACK HANDLE AND STAINLESS STEEL POINTED TIP BLADE  
SOLD IN CASE PACKS OF 1 DOZEN. **NEW!**



STK-1001  
9" L. DARK WOOD HANDLE WITH STAINLESS STEEL BLADE, POINTED TIP BLADE  
SOLD IN CASE PACKS OF 1 DOZEN. **NEW!**



STK-1002  
9" L. HALF WOOD HANDLE AND STAINLESS STEEL POINTED TIP BLADE  
SOLD IN CASE PACK OF 1 DOZEN. **NEW!**



STK-1003  
9" L. RED HANDLE AND STAINLESS STEEL POINTED TIP BLADE  
SOLD IN CASE PACKS OF 1 DOZEN. **NEW!**



STK-1004  
STAINLESS STEEL HANDLE AND POINTED TIP BLADE  
SOLD IN CASE PACKS OF 1 DOZEN. **NEW!**



STK-1005  
9" L. WOOD HANDLE WITH STAINLESS STEEL BLADE AND POINTED TIP BLADE  
SOLD IN CASE PACKS OF 1 DOZEN.



STK-500  
HANDLE IS POM, FULL TANG, POINTED TOP, 4.5" L. BLADE, 8.75" L.  
SOLD IN CASE PACKS OF 1 DOZEN.



STK-501  
9" L. SATIN FINISH STAINLESS STEEL, 5" L. BLADE, POINTED TIP  
SOLD IN CASE PACKS OF 2 DOZEN.



STK-502  
9" L. MIRROR FINISH STAINLESS STEEL, 5" L. BLADE, POINTED TIP  
SOLD IN CASE PACKS OF 2 DOZEN.



**ERIE STEAK KNIFE & BOX**

STK-800 ERIE STEAK KNIFE, SOLD IN CASE PACKS OF 1 DOZEN  
BX-800 PARISIAN BOX ONLY FOR ERIE STEAK





CASE PACK  
1 DOZEN  
1 EACH















































STK-JA  
9.5" L. MIRROR POLISHED STAINLESS STEEL YBOR CITY STEAK KNIFE  
SOLD IN CASE PACKS OF 1 DOZEN.



STK-JB  
9" L. PAKKAWOOD HANDLE WITH A STAINLESS STEEL BLADE  
SAN ANTONIO STEAK KNIFE, POINTED TIP  
SOLD IN CASE PACKS OF 1 DOZEN.

 <p><b>STK-A</b> 4" STAINLESS BLADE, POINTED TIP, HARDWOOD HANDLE SOLD IN CASE PACKS OF 3 DOZEN.</p>	 <p><b>STK-AA</b> 4 1/4" STAINLESS BLADE, POINTED TIP, AGATE WOOD HANDLE SOLD IN CASE PACKS OF 2 DOZEN.</p>	 <p><b>STK-AB</b> HALF TANG, PAKKA WOOD HANDLE 4 INCH POINTED BLADE, 2 RIVET SOLD IN CASE PACKS OF 2 DOZEN.</p>
 <p><b>STK-AD</b> BLACK PAKKA WOOD HANDLE, 5 INCH ROUNDED BLADE, 3 RIVET, FULL TANG SOLD IN CASE PACKS OF 2 DOZEN.</p>	 <p><b>STK-AL</b> KOBE STEAK KNIFE - <b>WITHOUT SERRATION</b> SOLD IN CASE PACKS OF 1 DOZEN.</p>	 <p><b>STK-AM</b> KOBE STEAK KNIFE - <b>WITH SERRATION</b> SOLD IN CASE PACKS OF 1 DOZEN.</p>
 <p><b>STK-AN</b> GAUCHO STEAK KNIFE, 5" POINTED TIP BLADE STAINLESS, POLYPROPYLENE HANDLE SOLD IN CASE PACKS OF 1 DOZEN.</p>	 <p><b>STK-B</b> 4 1/4" SS BLADE, POINTED TIP, BLACK POLYPROPYLENE HANDLE SOLD IN CASE PACKS OF 3 DOZEN.</p>	 <p><b>STK-C</b> 5" ROUND BLADE, STAINLESS STEEL STEAK HOLLOW HANDLE, SATIN FINISH SOLD IN CASE PACKS OF 1 DOZEN.</p>
 <p><b>STK-CC</b> 10" L., ROUND TIP, JUMBO STEAK KNIFE, ALL STAINLESS, BRUSHED SATIN FINISH SOLD IN CASE PACKS OF 1 DOZEN.</p>	 <p><b>STK-D</b> 5" SS BLADE, POINTED TIP, 2 RIVET, HARDWOOD HANDLE SOLD IN CASE PACKS OF 3 DOZEN.</p>	 <p><b>STK-E</b> 5" STAINLESS BLADE, POINTED TIP, 3 RIVET, BLACK DELRIN HANDLE, HEAVY DUTY FULL TANG SOLD IN CASE PACKS OF 1 DOZEN.</p>
 <p><b>STK-EF</b> 5" STAINLESS BLADE, BIG RED JUMBO BRAZILIAN POLYWOOD HANDLE POINTED TIP, HEAVY DUTY FULL TANG, 3 RIVET SOLD IN CASE PACKS OF 1 DOZEN.</p>	 <p><b>STK-F</b> 4 5/8" STAINLESS BLADE, POINTED TIP, BLACK POLYPROPYLENE HANDLE SOLD IN CASE PACKS OF 3 DOZEN.</p>	 <p><b>STK-FG</b> 5" POINTED BLAD, ROSEWOOD HANDLE SOLD IN CASE PACKS OF 1 DOZEN.</p>
 <p><b>STK-G</b> 5" SS BLADE, ROUND TIP, SON OF STK-Z, SATIN FINISH HOLLOW HANDLE SOLD IN CASE PACKS OF 1 DOZEN.</p>	 <p><b>STK-H</b> 4 5/8" SS BLADE, ROUND TIP, BLACK POLYPROPYLENE HANDLE SOLD IN CASE PACKS OF 2 DOZEN.</p>	 <p><b>STK-I</b> 4 1/4" SS BLADE, ROUND TIP, BLACK POLYPROPYLENE HANDLE SOLD IN CASE PACKS OF 3 DOZEN.</p>
 <p><b>STK-J</b> 3 3/4" SS BLADE, ROUND TIP, 2 RIVET, PAKKAWOOD HANDLE SOLD IN CASE PACKS OF 1 DOZEN.</p>	 <p><b>STK-K</b> 4" SS BLADE, FULL TANG, POINTED TIP, PAKKAWOOD HANDLE SOLD IN CASE PACKS OF 2 DOZEN.</p>	 <p><b>STK-L</b> 5" SS BLADE, ROUND TIP, 3 RIVET, BLACK DELRIN PLASTIC HANDLE, HEAVY DUTY FULL TANG SOLD IN CASE PACKS OF 1 DOZEN.</p>
 <p><b>STK-N</b> 5" SS BLADE, POINTED TIP, JUMBO, HOLLOW SS HANDLE, MIRROR FINISH SOLD IN CASE PACKS OF 1 DOZEN.</p>	 <p><b>STK-O</b> 5" SS BLADE, POINTED TIP, 3-RIVET, JUMBO, HARDWOOD HANDLE SOLD IN CASE PACKS OF 1 DOZEN.</p>	 <p><b>STK-P</b> 5" SS BLADE, POINTED TIP, 3 RIVET, BROWN PAKKAWOOD HANDLE SOLD IN CASE PACKS OF 1 DOZEN.</p>

 <p><b>STK-PS</b> SLIM EURO STYLE STEAK KNIFE, 9 1/8" L. BLADE, POINTED TIP, BLACK ABS PLASTIC HANDLE, HIGH CARBON SOLD IN CASE PACKS OF 3 DOZEN.</p>	 <p><b>STK-PW</b> BARON EURO STYLE STEAK KNIFE, 9 3/4" L., POINTED TIP, BLACK ABS PLASTIC HANDLE, HIGH CARBON SOLD IN CASE PACKS OF 3 DOZEN.</p>	 <p><b>STK-Q</b> 4" SS BLADE, POINTED TIP, 2 RIVET, BLACK PLASTIC EBONY HANDLE SOLD IN CASE PACKS OF 1 DOZEN.</p>
 <p><b>STK-R</b> 5" SS BLADE, ROUND TIP, 3 RIVET, JUMBO STAINED HARDWOOD HANDLE SOLD IN CASE PACKS OF 1 DOZEN.</p>	 <p><b>STK-RS</b> 5" SS BLADE, JUMBO LACQUERED HARDWOOD HANDLE, ROUND TIP, FULL TANG, HEAVY DUTY SOLD IN CASE PACKS OF 1 DOZEN.</p>	 <p><b>STK-S</b> 5" SS BLADE, ROUND TIP, 2 RIVET, JUMBO HARDWOOD HANDLE SOLD IN CASE PACKS OF 1 DOZEN.</p>
 <p><b>STK-SB</b> FULL TANG STEAK KNIFE, 9.25" LONG BLACK BAKELITE HANDLE, POINTED TIP SOLD IN CASE PACKS OF 3 DOZEN.</p>	 <p><b>STK-U</b> 5" SS BLADE, POINTED TIP, 2 RIVET, JUMBO HARDWOOD HANDLE SOLD IN CASE PACKS OF 1 DOZEN.</p>	 <p><b>STK-V</b> 5" STEAK KNIFE, JUMBO POLY HANDLE, 2 RIVET SOLD IN CASE PACKS OF 1 DOZEN.</p>
 <p><b>STK-W</b> 5" SS BLADE, ROUND TIP, JUMBO, POLYPROPYLENE HANDLE SOLD IN CASE PACKS OF 1 DOZEN.</p>	 <p><b>STK-X</b> 5" SS BLADE, BLACK DELRIN HANDLE, HEAVY DUTY FULL TANG, ROUND TIP SOLD IN CASE PACKS OF 1 DOZEN.</p>	 <p><b>STK-XZ</b> 5" STAINLESS BLADE, BUCKSTAG DELRIN HANDLE, JUMBO, HEAVY DUTY FULL TANG, POINTED TIP SOLD IN CASE PACKS OF 1 DOZEN.</p>
 <p><b>STK-Y</b> 5" SS BLADE, POINTED TIP, 3 SILVER RIVET, FULL TANG, BLACK POLY HANDLE SOLD IN CASE PACKS OF 1 DOZEN.</p>	 <p><b>STK-Z</b> 5" SS BLADE, POINTED TIP, JUMBO, HOLLOW HANDLE, SATIN FINISH SOLD IN CASE PACKS OF 1 DOZEN.</p>	 <p><b>STK-ZC</b> 5" BLADE, FULL TANG, BLACK/RED PAKKA WOOD HANDLE, DOUBLE STAINLESS STEEL BOLSTER, JUMBO SIZE SOLD IN CASE PACKS OF 1 DOZEN.</p>
 <p><b>STK-ZD</b> 5" BLADE, FULL TANG, BLACK DELRIN HANDLE, DOUBLE SS BOLSTER, JUMBO SIZE SOLD IN CASE PACKS OF 1 DOZEN.</p>	 <p><b>STK-ZE</b> 9 1/4" L., 1 PC., CREST, MOTHER OF PEARL POLYESTER RESIN HANDLE SOLD IN CASE PACKS OF 1 DOZEN.</p>	 <p><b>STK-ZF</b> 9 3/8" L., 1 PC., CASPIAN, POLYOXYMETHYLENE BLACK HANDLE SOLD IN CASE PACKS OF 1 DOZEN.</p>
 <p><b>STK-ZG</b> 3.75" ROUND TIP, STAINLESS BLADE, ROUND TIP, DARK HARDWOOD HANDLE SOLD IN CASE PACKS OF 2 DOZEN.</p>	 <p><b>STK-ZH</b> PARISIAN STEAK KNIFE, STAINLESS STEEL BLADE WITH A POINTED TIP, BLACK DELRIN PLASTIC HANDLE SOLD IN CASE PACKS OF 1 DOZEN.</p>	 <p><b>STK-ZI</b> HIGH PLAINS STEAK KNIFE, JUMBO STAINLESS STEEL BLADE WITH POINTED TIP, BLACK DELRIN PLASTIC HANDLE SOLD IN CASE PACKS OF 1 DOZEN.</p>
 <p><b>STK-ZJ</b> HUNTER STEAK KNIFE, JUMBO STAINLESS STEEL BLADE WITH A POINTED TIP, BROWN DELRIN PLASTIC HANDLE SOLD IN CASE PACKS OF 1 DOZEN.</p>	 <p><b>STK-ZK</b> RED STEAK KNIFE 4 1/8" STAINLESS STEEL BLADE WITH ROUND TIP, RED POLYWOOD HANDLE SOLD IN CASE PACKS OF 2 DOZEN.</p>	 <p><b>STK-ZL</b> 4.75" STAINLESS STEEL BLADE WITH A ROUND TIP, DARK HARDWOOD HANDLE SOLD IN CASE PACKS OF 1 DOZEN.</p>

 <p><b>STK-ZM</b> KANSAS CITY STEAK KNIFE, STAINLESS STEEL BLADE, ROUND TIP, BLACK DELRIN PLASTIC HANDLE SOLD IN CASE PACKS OF 1 DOZEN.</p>	 <p><b>STKZ-ZN</b> 9.5" REFLECTIONS STEAK KNIFE 1-PC. SOLD IN CASE PACKS OF 1 DOZEN.</p>	 <p><b>STK-200</b> 9.5" L., FULL TANG, 3 RIVET, SPANISH PAKKAWOOD HANDLE SOLD IN CASE PACKS OF 1 DOZEN.</p>						
 <p><b>STK-201</b> 9.5" L., SATIN FINISH HANDLE, ROUNDED TIP SOLD IN CASE PACKS OF 1 DOZEN.</p>	 <p><b>STK-300</b> 8.85" L. SLEEK STAINLESS STEEL SOLD IN CASE PACKS OF 1 DOZEN.</p>	 <p><b>STK-301</b> 8.85" L. RAMBO STAINLESS STEEL SOLD IN CASE PACKS OF 1 DOZEN.</p>						
 <p><b>STK-302</b> 11.3" L. ALPS STAINLESS SOLD IN CASE PACKS OF 1 DOZEN.</p>	 <p><b>STK-303</b> 8.9" L. JUMBO STAINLESS STEEL SOLD IN CASE PACKS OF 1 DOZEN.</p>	 <p><b>STK-304</b> 8.5" L. SLIM STAINLESS STEEL SOLD IN CASE PACKS OF 1 DOZEN.</p>						
 <p><b>STK-305</b> 9" L. STEAK KNIFE WITH BLACK HANDLE SOLD IN CASE PACKS OF 1 DOZEN.</p>	 <p><b>STK-306</b> 9.2" L. FULL STAINLESS STEEL SOLD IN CASE PACKS OF 1 DOZEN.</p>	 <p><b>STK-307</b> 9.25" L. SUTIL STAINLESS STEEL SOLD IN CASE PACKS OF 1 DOZEN.</p>						
 <p><b>STK-308</b> 11.5" L. STAINLESS STEEL, PARTIAL FAUX WOOD HANDLE SOLD IN CASE PACKS OF 1 DOZEN.</p>	 <p><b>STK-411</b> ABS HANDLE STEAK KNIFE, BLACK HANDLE, 4 1/4" HANDLE, 4 5/8" BLADE SOLD IN CASE PACKS OF 1 DOZEN.</p>	 <p><b>STK-412</b> POM HANDLE STEAK KNIFE, BLACK HANDLE, 4 1/2" HANDLE, 4 1/2" BLADE SOLD IN CASE PACKS OF 1 DOZEN.</p>						
 <p><b>FL-5123</b> 5" SS BLADE, POINTED TIP, SS PISTOL GRIP HANDLE SOLD IN CASE PACKS OF 3 DOZEN.</p>	 <p><b>STK-1952882</b> SLIM RADIANT STEAK KNIFE, 9 1/4"L., POINT TIP, HIGH CARBON STAINLESS BLADE SOLD IN CASE PACKS OF 1 DOZEN.</p>	 <p><b>STK-1952892</b> BARON RADIANT STEAK KNIFE, 10 1/4" L., POINT TIP, HIGH CARBON SS BLADE SOLD IN CASE PACKS OF 1 DOZEN.</p>						
 <p><b>STK-2001432</b> BEEF BARON II STEAK KNIFE, 10" L. RED PAKKA WOOD HANDLE SOLD IN CASE PACKS OF 1 DOZEN.</p>	 <p><b>FL-6322</b> JUMBO STAINLESS STEEL HANDLED STEAK KNIFE &amp; HAMMERED FINISH SOLD IN CASE PACKS OF 1 DOZEN.</p>	 <p><b>WOODEN STEAK KNIFE BOX HOLDS 6 KNIVES</b> STK-ZZ 2" H. x 11.38" W. x 8.25" D.</p>						
<p align="center"><b>JUMBO STEAK KNIFE GIFT BOX WITH COVER</b></p> <p align="center">JUMBO STEAK KNIFE GIFT BOX WITH COVER, RED VELVET INSIDE, BLACK OUTSIDE.</p> <table border="0"> <tr> <td data-bbox="670 2587 755 2616">KNVBX-225</td> <td data-bbox="819 2587 861 2616">1 PC.</td> <td data-bbox="925 2587 1266 2616">JUMBO STEAK KNIFE GIFT BOX WITH COVER</td> </tr> <tr> <td data-bbox="670 2631 755 2660">KNVBX-226</td> <td data-bbox="819 2631 861 2660">4 PCS.</td> <td data-bbox="925 2631 1266 2660">JUMBO STEAK KNIFE GIFT BOX WITH COVER</td> </tr> </table>			KNVBX-225	1 PC.	JUMBO STEAK KNIFE GIFT BOX WITH COVER	KNVBX-226	4 PCS.	JUMBO STEAK KNIFE GIFT BOX WITH COVER
KNVBX-225	1 PC.	JUMBO STEAK KNIFE GIFT BOX WITH COVER						
KNVBX-226	4 PCS.	JUMBO STEAK KNIFE GIFT BOX WITH COVER						

**FLATWARE**



ONEIDA

**CHATEAU (18/8 STAINLESS)**  
SOLD IN CASE PACKS OF DOZEN.

		CASE PACK
FL-133601	TEASPOON	3 DOZ.
FL-133603	SERVING SPOON	1 DOZ.
FL-133604	ICED TEA SPOON	3 DOZ.
FL-133605	DINNER FORK	3 DOZ.
FL-133606	SALAD/DESSERT FORK	3 DOZ.
FL-133607	DESSERT SPOON	3 DOZ.
FL-133610	BUTTER SPREADER, F.H.	1 DOZ.
FL-133611	BUTTER KNIFE, F.H.	1 DOZ.
FL-133612	BOUILLON SPOON	3 DOZ.
FL-133615	COCKTAIL FORK	3 DOZ.
FL-1336451	DINNER KNIFE, 1 PC.	3 DOZ.

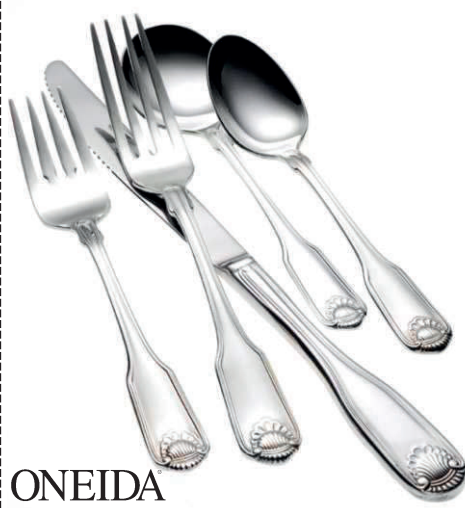

ONEIDA

**SILVER SHELL (SILVERPLATE)**  
SOLD IN CASE PACKS OF DOZEN.

		CASE PACK
FL-132601	TEASPOON	3 DOZ.
FL-132605	AMERICAN DINNER FORK	3 DOZ.
FL-132606	SALAD/DESSERT FORK	3 DOZ.
FL-132607	OVAL DESSERT SPOON	3 DOZ.
FL-132611	BUTTER SPREADER, 1 PC.	3 DOZ.
FL-132612	BOUILLON SPOON	3 DOZ.
FL-132629	DEMITASSE SPOON	3 DOZ.
FL-132645	DINNER KNIFE, HEAVY 1 PC.	3 DOZ.



ONEIDA

**ROSEWOOD (18/10 STAINLESS)**  
SOLD IN CASE PACKS OF DOZENS.

		CASE PACK
FL-37510	TEASPOON	3 DOZ.
FL-37520	DESSERT SPOON	3 DOZ.
FL-37530	BOUILLON SPOON	3 DOZ.
FL-37550	DEMITASSE SPOON	3 DOZ.
FL-37610	DINNER FORK	3 DOZ.
FL-37620	SALAD FORK	3 DOZ.
FL-37630	COCKTAIL FORK	3 DOZ.
FL-37711	DINNER KNIFE, 1 PC.	3 DOZ.

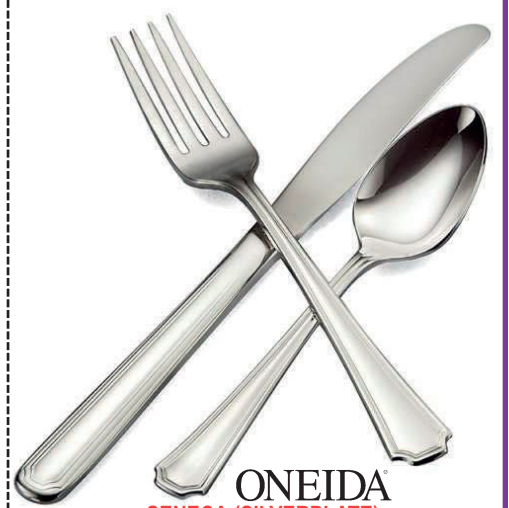

ONEIDA  
**SENECA (SILVERPLATE)**

SOLD IN CASE PACKS OF DOZEN.

		CASE PACK
FL-132701	TEASPOON	3 DOZ.
FL-132703	SERVING SPOON	3 DOZ.
FL-132705	AMERICAN DINNER FORK	3 DOZ.
FL-132706	SALAD/DESSERT FORK	3 DOZ.
FL-132707	OVAL DESSERT SPOON	3 DOZ.
FL-132710	BUTTER SPREADER, F.H.	3 DOZ.
FL-132712	BOUILLON SPOON	3 DOZ.
FL-132715	OYSTER/COCKTAIL FORK	3 DOZ.
FL-132729	DEMITASSE SPOON	3 DOZ.
FL-1327451	DINNER KNIFE, 1 PC.	3 DOZ.



ONEIDA

**PEARL (18/10 STAINLESS)**  
A STRAND OF GRADUATED BEADS EMBELLISHES THE BORDER OF THIS COLLECTION. SOLD IN CASE PACKS OF DOZEN.

		CASE PACK
FL-16301	TEASPOON	1 DOZ.
FL-16303	TABLE/SERVING SPOON	1 DOZ.
FL-16304	ICED TEA SPOON	1 DOZ.
FL-16305	DINNER FORK	1 DOZ.
FL-163051	EURO TABLE FORK	1 DOZ.
FL-16306	SALAD FORK	1 DOZ.
FL-16307	DESSERT SPOON	1 DOZ.
FL-16310	BUTTER SPREADER, F.H.	1 DOZ.
FL-16311	1-PC BUTTER KNIFE	1 DOZ.
FL-16312	ROUND BOWL SOUP SPOON	1 DOZ.
FL-16315	COCKTAIL FORK	1 DOZ.
FL-16322	1-PC STEAK KNIFE	1 DOZ.
FL-16329	DEMI SPOON	1 DOZ.
FL-16345	1-PC DINNER KNIFE	1 DOZ.



ONEIDA

**CROYDTON (SILVERPLATE)**  
SOLD IN CASE PACKS OF DOZEN.

		CASE PACK
FL-132401	TEASPOON	3 DOZ.
FL-132405	AMERICAN DINNER FORK	3 DOZ.
FL-132406	SALAD/DESSERT FORK	3 DOZ.
FL-132407	OVAL DESSERT SPOON	3 DOZ.
FL-132410	BUTTER SPREADER, F.H.	3 DOZ.
FL-132412	BOUILLON SPOON	3 DOZ.
FL-132415	OYSTER/COCKTAIL FORK	3 DOZ.
FL-132429	DEMITASSE SPOON	3 DOZ.
FL-132445	DINNER KNIFE, 1 PC.	3 DOZ.
FL-1324451	DINNER KNIFE, HEAVY 1 PC.	3 DOZ.



ONEIDA

**ETON (SILVERPLATE)**  
SOLD IN CASE PACKS OF DOZEN.

		CASE PACK
FL-600201	6" L. TEASPOON	3 DOZ.
FL-600203	8 1/8" L. SERVING/TABLE SPOON	3 DOZ.
FL-600204	7 1/4" L. ICED TEA SPOON	3 DOZ.
FL-600205	7 1/4" L. DINNER FORK	3 DOZ.
FL-600206	6 5/8" L. SALAD FORK	3 DOZ.
FL-600207	7 1/4" L. DESSERT SPOON	3 DOZ.
FL-600210	6 1/8" L. BUTTER SPREADER, F.H.	3 DOZ.
FL-600211	7" L. BUTTER SPREADER, 1 PC.	3 DOZ.
FL-600212	5 3/4" L. BOUILLON SPOON	3 DOZ.
FL-600215	6" L. OYSTER/COCKTAIL FORK	3 DOZ.
FL-600222	9 1/2" L. STEAK KNIFE, 1 PC.	3 DOZ.
FL-600229	4 1/4" L. DEMITASSE SPOON	3 DOZ.
FL-600245	8 1/2" L. DINNER KNIFE, 1 PC.	3 DOZ.
FL-6002451	9 1/2" L. DINNER KNIFE, 1 PC. HEAVY	3 DOZ.

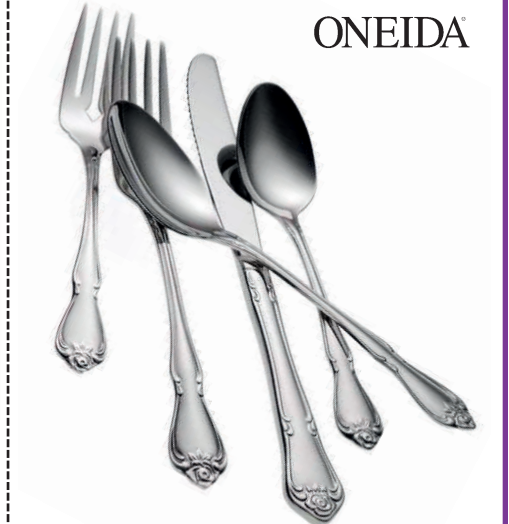

ONEIDA

**ARBOR ROSE (18/8 STAINLESS)**  
SOLD IN CASE PACKS OF DOZEN.

		CASE PACK
FL-390101	TEASPOON	3 DOZ.
FL-390103	SERVING SPOON	1 DOZ.
FL-390104	ICED TEA SPOON	3 DOZ.
FL-390105	AMERICAN DINNER FORK	3 DOZ.
FL-390106	SALAD/DESSERT FORK	3 DOZ.
FL-390107	DESSERT SPOON	3 DOZ.
FL-390112	BOUILLON SPOON	3 DOZ.
FL-390115	OYSTER/COCKTAIL FORK	3 DOZ.
FL-390145	DINNER KNIFE, S.H., 1 PC.	3 DOZ.



ONEIDA

**BAGUETTE (18/10 STAINLESS)**  
SOLD IN CASE PACKS OF DOZEN.

		CASE PACK
FL-14830	TEASPOON, AMERICAN	1 DOZ.
FL-14831	TEASPOON, EUROPEAN	1 DOZ.
FL-14832	DESSERT SPOON	1 DOZ.
FL-14833	BOUILLON SPOON	1 DOZ.
FL-14835	ICED TEA SPOON	1 DOZ.
FL-14836	DEMITASSE SPOON	1 DOZ.
FL-14837	TABLE/SERVING SPOON	1 DOZ.
FL-14838	DINNER FORK	1 DOZ.
FL-14839	TABLE FORK	1 DOZ.
FL-14840	SALAD/DESSERT FORK	1 DOZ.
FL-14841	COCKTAIL FORK	1 DOZ.
FL-14842	DINNER KNIFE, H.H.	1 DOZ.
FL-14843	TABLE KNIFE, 1 PC.	1 DOZ.
FL-14844	DESSERT KNIFE, 1 PC.	1 DOZ.
FL-14845	DESSERT KNIFE, H.H.	1 DOZ.
FL-14846	STEAK KNIFE, H.H.	1 DOZ.
FL-14847	BUTTER KNIFE, H.H.	1 DOZ.
FL-14848	BUTTER SPREADER, F.H.	1 DOZ.



ONEIDA

**COLOSSEUM (STAINLESS STEEL)**  
SOLD IN CASE PACKS OF DOZEN.

		CASE PACK
FL-06101	TEASPOON	1 DOZ.
FL-06103	TABLE/SERVING SPOON	1 DOZ.
FL-06106	SALAD/DESSERT FORK	1 DOZ.
FL-06107	OVAL DESSERT SPOON	1 DOZ.
FL-06111	BUTTER KNIFE, 1 PC.	1 DOZ.
FL-06112	BOUILLON SPOON	1 DOZ.
FL-06114	FISH FORK	1 DOZ.
FL-06115	OYSTER/COCKTAIL FORK	1 DOZ.
FL-06122	STEAK KNIFE, 1 PC.	1 DOZ.
FL-06129	A.D. COFFEE SPOON	1 DOZ.
FL-06139	FISH KNIFE, 1 PC.	1 DOZ.
FL-06145	DINNER KNIFE, 1 PC.	1 DOZ.
FL-061051	TABLE FORK, EURO. SIZE	1 DOZ.



**ORBITER (MAGNETIC STAINLESS)**  
MADE FROM MAGNETIC STAINLESS WITH A MIRROR FINISH.  
SOLD IN CASE PACKS OF DOZEN.

		CASE PACK
FL-0401	TEASPOON	1 DOZ.
FL-0403	SERVING SPOON	1 DOZ.
FL-0404	ICED TEA SPOON	1 DOZ.
FL-0405	DINNER FORK	1 DOZ.
FL-04051	EURO. FORK	1 DOZ.
FL-0406	SALAD FORK	1 DOZ.
FL-0407	DESSERT SPOON	1 DOZ.
FL-0412	BOUILLON SPOON	1 DOZ.
FL-0415	COCKTAIL FORK	1 DOZ.
FL-0429	DEMI SPOON	1 DOZ.
FL-0445	DINNER KNIFE	1 DOZ.
FL-04451	EURO. KNIFE	1 DOZ.
FL-0490	5 PC PLACE SETTING, EURO	1 EA.
FL-0499	5 PC PLACE SETTING, US	1 EA.



**CHANTELLE (18/10 STAINLESS)**  
SOLD IN CASE PACKS OF DOZEN.

		CASE PACK
FL-8501	TEASPOON	1 DOZ.
FL-8503	TABLE SPOON	1 DOZ.
FL-8504	ICED TEA SPOON	1 DOZ.
FL-8505	DINNER FORK	1 DOZ.
FL-8506	SALAD FORK	1 DOZ.
FL-8507	DINNER SPOON	1 DOZ.
FL-8510	BUTTER SPREADER	1 DOZ.
FL-8512	BOUILLON SPOON	1 DOZ.
FL-8515	OYSTER FORK	1 DOZ.
FL-8522	DINNER KNIFE S.H.	1 DOZ.
FL-8529	DEMITASSE SPOON	1 DOZ.
FL-85051	TABLE FORK	1 DOZ.



**BAYPOINT (18/0 STAINLESS)**  
SOLD IN CASE PACKS OF DOZEN.

		CASE PACK
FL-8301	TEASPOON	1 DOZ.
FL-8303	SERVING SPOON	1 DOZ.
FL-8304	ICED TEASPOON	1 DOZ.
FL-8305	DINNER FORK	1 DOZ.
FL-83051	EURO DINNER FORK	1 DOZ.
FL-8306	SALAD FORK	1 DOZ.
FL-8307	DESSERT SPOON	1 DOZ.
FL-8311	FH BUTTER SPREADER	1 DOZ.
FL-8312	BOUILLON SPOON	1 DOZ.
FL-8315	COCKTAIL FORK	1 DOZ.
FL-8329	DEMI SPOON	1 DOZ.
FL-8345	DINNER KNIFE	1 DOZ.
FL-83451	EURO. DINNER KNIFE	1 DOZ.
FL-8390	EUROPEAN 5 PIECE SET	1 EA.
FL-8399	AMERICAN 5 PIECE SET	1 EA.



**PATRICIAN (STAINLESS)**  
SOLD IN CASE PACKS OF DOZEN.

		CASE PACK
FL-33801	TEASPOON	3 DOZ.
FL-33803	SERVING SPOON	2 DOZ.
FL-33804	ICED TEA SPOON	2 DOZ.
FL-33805	DINNER FORK	2 DOZ.
FL-33806	SALAD FORK	2 DOZ.
FL-33807	DESSERT SPOON	2 DOZ.
FL-33810	BUTTER SPREADER	2 DOZ.
FL-33812	BOUILLON SPOON	2 DOZ.
FL-33815	COCKTAIL FORK	2 DOZ.
FL-33845	1 PC KNIFE	1 DOZ.
FL-33899	5 PC PLACE SETTING, US	1 EA.



**BEACON (18/0 STAINLESS STEEL)**  
SOLD IN CASE PACKS OF DOZEN.

		CASE PACK
FL-6701	TEASPOON	3 DOZ.
FL-6703	SERVING SPOON	2 DOZ.
FL-6704	ICED TEA SPOON	2 DOZ.
FL-6705	DINNER FORK	2 DOZ.
FL-6706	SALAD FORK	2 DOZ.
FL-6707	DESSERT SPOON	2 DOZ.
FL-6712	BOUILLON SPOON	2 DOZ.
FL-6715	COCKTAIL FORK	2 DOZ.
FL-6720	1 PC. KNIFE	1 DOZ.
FL-6790	5 PC. SETTING, US	1 EA.



**POISE (STAINLESS)**  
SOLD IN CASE PACKS OF DOZEN.

		CASE PACK
FL-5501	TEASPOON	2 DOZ.
FL-5504	ICED TEA SPOON	2 DOZ.
FL-5505	DINNER FORK	2 DOZ.
FL-5506	SALAD FORK	2 DOZ.
FL-5507	DESSERT SPOON	1 DOZ.
FL-5512	BOUILLON SPOON	2 DOZ.
FL-5515	COCKTAIL FORK	2 DOZ.
FL-5545	1 PC. KNIFE	1 DOZ.
FL-5599	5 PC PLACE SETTING, US	1 EA.



**DANISH PRIDE (STAINLESS)**

THE HANDLES HAVE A SMALL SHELL LIKE DESIGN AT THE BOTTOM, SOLD IN CASE PACKS OF DOZEN.

		CASE PACK
FL-5401	TEASPOON	3 DOZ.
FL-5403	SERVING SPOON	3 DOZ.
FL-5405	DINNER FORK	3 DOZ.
FL-5412	BOUILLON SPOON	3 DOZ.
FL-5445	DINNER KNIFE	3 DOZ.
FL-5499	5 PC PLACE SETTING, US	1 EA.



**WINDSOR SUPREME (STAINLESS)**  
SOLD IN CASE PACKS OF DOZEN.

		CASE PACK
FL-5001	TEASPOON	3 DOZ.
FL-5004	ICED TEA SPOON	2 DOZ.
FL-5005	DINNER FORK	2 DOZ.
FL-50051	EURO. FORK	2 DOZ.
FL-5006	SALAD FORK	2 DOZ.
FL-5007	DESSERT SPOON	2 DOZ.
FL-5012	BOUILLON SPOON	2 DOZ.
FL-5015	COCKTAIL FORK	2 DOZ.
FL-5045	1 PC KNIFE	1 DOZ.



**CHANTECLAIR (18/10 STAINLESS STEEL)**  
SOLD IN CASE PACKS OF DOZEN.

		CASE PACK
FL-853101	TEASPOON	3 DOZ.
FL-853103	SERVING SPOON	1 DOZ.
FL-853104	ICED TEA SPOON	3 DOZ.
FL-853105	DINNER FORK	3 DOZ.
FL-853106	SALAD FORK	3 DOZ.
FL-853107	DESSERT SPOON	3 DOZ.
FL-853110	DESSERT SPREADER	1 DOZ.
FL-853111	BUTTER KNIFE	1 DOZ.
FL-853112	BOUILLON SPOON	3 DOZ.
FL-853115	COCKTAIL FORK	3 DOZ.
FL-853129	DEMITASSE SPOON	3 DOZ.
FL-853138	ROUND BOWL SOUP SPOON	3 DOZ.
FL-853145	DINNER KNIFE	3 DOZ.
FL-853190	5 PC. SETTING, EURO	1 EA.
FL-853199	5 PC. SETTING, US	1 EA.



**COHASSET (18/0 STAINLESS STEEL)**  
THE COHASSET FLATWARE HAS A TRADITIONAL HANDLE BUT A UNIQUE AND MODERN HAMMERED DESIGN.

		CASE PACK
FL-6201	TEASPOON	1 DOZ.
FL-6204	ICED TEASPOON	1 DOZ.
FL-6205	DINNER FORK	1 DOZ.
FL-62051	EURO DINNER FORK	1 DOZ.
FL-6206	SALAD FORK	1 DOZ.
FL-6207	DESSERT SPOON	1 DOZ.
FL-6212	BOUILLON SPOON	1 DOZ.
FL-6215	COCKTAIL FORK	1 DOZ.
FL-6229	DEMI SPOON	1 DOZ.
FL-6245	DINNER KNIFE	1 DOZ.
FL-62451	EURO. DINNER KNIFE	1 DOZ.
FL-6290	EUROPEAN 5 PIECE SET	1 EA.
FL-6299	AMERICAN 5 PIECE SET	1 EA.



**MODERNAIR (18/10 STAINLESS)**  
SOLD IN CASE PACKS OF DOZEN.

		CASE PACK
FL-2001	TEASPOON	1 DOZ.
FL-2003	SERVING SPOON	1 DOZ.
FL-2004	ICED TEA SPOON	1 DOZ.
FL-2005	DINNER FORK	1 DOZ.
FL-2006	SALAD FORK	1 DOZ.
FL-2007	DESSERT SPOON	1 DOZ.
FL-2011	BUTTER SPREADER	1 DOZ.
FL-2012	BOUILLON SPOON	1 DOZ.
FL-2015	COCKTAIL FORK	1 DOZ.
FL-2029	DEMITASSE SPOON	1 DOZ.
FL-2045	KNIFE, 1 PC.	1 DOZ.
FL-20051	EUROPEAN FORK	1 DOZ.
FL-20451	EUROPEAN KNIFE, 1 PC.	1 DOZ.
FL-2090	5 PC. SETTING, EURO	1 EA.
FL-2099	5 PC. SETTING, US	1 EA.



**ATHENIAN (18/10 STAINLESS)**  
SOLD IN CASE PACKS OF DOZEN.

		CASE PACK
FL-2601	TEASPOON	1 DOZ.
FL-2603	SERVING SPOON	1 DOZ.
FL-2604	ICED TEA SPOON	1 DOZ.
FL-2605	DINNER FORK	1 DOZ.
FL-2606	SALAD FORK	1 DOZ.
FL-2607	DESSERT SPOON	1 DOZ.
FL-2611	BUTTER SPREADER	1 DOZ.
FL-2612	BOUILLON SPOON	1 DOZ.
FL-2615	COCKTAIL FORK	1 DOZ.
FL-2629	DEMITASSE SPOON	1 DOZ.
FL-2645	KNIFE, 1 PC.	1 DOZ.
FL-26051	EUROPEAN FORK	1 DOZ.
FL-26451	EUROPEAN KNIFE, 1 PC.	1 DOZ.
FL-2690	5 PC. SETTING, EURO	1 EA.
FL-2699	5 PC. SETTING, US	1 EA.



**HYANNI (18/8 STAINLESS)**  
SOLD IN CASE PACKS OF DOZEN.

		CASE PACK
FL-4901	TEASPOON	3 DOZ.
FL-4902	SERVING SPOON	2 DOZ.
FL-4903	ICED TEA SPOON	2 DOZ.
FL-4905	DINNER FORK	2 DOZ.
FL-4906	SALAD FORK	2 DOZ.
FL-4907	DESSERT SPOON	2 DOZ.
FL-4911	BUTTER KNIFE, S.H.	1 DOZ.
FL-4912	BOUILLON SPOON	2 DOZ.
FL-4915	COCKTAIL FORK	2 DOZ.
FL-4945	KNIFE, 1 PC.	1 DOZ.
FL-49051	EUROPEAN FORK	2 DOZ.
FL-49451	EUROPEAN KNIFE, 1 PC.	1 DOZ.
FL-4990	5 PC. SETTING, EURO	1 EA.
FL-4999	5 PC. SETTING, US	1 EA.



**NAPPA (STAINLESS STEEL)**  
SOLD IN CASE PACKS OF DOZEN.

		CASE PACK
FL-578101	TEASPOON	3 DOZ.
FL-578103	SERVING SPOON	2 DOZ.
FL-578104	ICED TEA SPOON	2 DOZ.
FL-578105	DINNER FORK	2 DOZ.
FL-578106	SALAD FORK	2 DOZ.
FL-578107	DESSERT SPOON	2 DOZ.
FL-578111	BUTTER KNIFE, S.H.	1 DOZ.
FL-578112	BOUILLON SPOON	2 DOZ.
FL-578115	COCKTAIL FORK	2 DOZ.
FL-578129	DEMITASSE SPOON	2 DOZ.
FL-578145	DINNER KNIFE	1 DOZ.
FL-5781051	EUROPEAN FORK	2 DOZ.
FL-5781451	EUROPEAN TABLE KNIFE	1 DOZ.
FL-578199	5 PC. SETTING, US	1 EA.



**SOPRANO (18/10 STAINLESS)**  
HEAVY DUTY ROUND FORGED HANDLES.  
SOLD IN CASE PACKS OF DOZEN.

**MIRROR FINISH**

		CASE PACK
FL-5201	TEASPOON	1 DOZ.
FL-5204	ICED TEA SPOON	1 DOZ.
FL-5205	DINNER FORK	1 DOZ.
FL-52051	EUROPEAN DINNER FORK	1 DOZ.
FL-520514S	EURO TABLE FORK, 4 TINES	1 DOZ.
FL-5207	DESSERT SPOON	1 DOZ.
FL-5211	BUTTER KNIFE, S.H.	1 DOZ.
FL-5212	BOUILLON SPOON	1 DOZ.
FL-5215	COCKTAIL FORK	1 DOZ.
FL-52451	EUROPEAN KNIFE, S.H.	1 DOZ.
FL-5290	5 PC. SETTING, EURO	1 EA.

**SATIN FINISH**

		CASE PACK
FL-5201S	TEASPOON	1 DOZ.
FL-5204S	ICED TEA SPOON	1 DOZ.
FL-5205S	DINNER FORK	1 DOZ.
FL-52051S	EUROPEAN DINNER FORK	1 DOZ.
FL-520514S	EURO TABLE FORK, 4 TINES	1 DOZ.
FL-5207S	DESSERT SPOON	1 DOZ.
FL-5211S	BUTTER KNIFE, S.H.	1 DOZ.
FL-5212S	BOUILLON SPOON	1 DOZ.
FL-5215S	COCKTAIL FORK	1 DOZ.
FL-52451S	EUROPEAN KNIFE, S.H.	1 DOZ.
FL-52903	5 PC. SETTING, EURO	1 EA.



**DRAMATIQUE (18/10 STAINLESS STEEL)**  
SOLD IN CASE PACKS OF DOZEN.

		CASE PACK
FL-852201	TEASPOON	1 DOZ.
FL-852203	SERVING SPOON	1 DOZ.
FL-852204	ICED TEA SPOON	1 DOZ.
FL-852205	DINNER FORK	1 DOZ.
FL-852206	SALAD FORK	1 DOZ.
FL-852207	DESSERT SPOON	1 DOZ.
FL-852211	BUTTER KNIFE	1 DOZ.
FL-852212	BOUILLON SPOON	1 DOZ.
FL-852215	COCKTAIL FORK	1 DOZ.
FL-852229	DEMITASSE SPOON	1 DOZ.
FL-852245	1 PC. DINNER KNIFE	1 DOZ.
FL-8522051	EUROPEAN FORK	1 DOZ.
FL-8522451	EUROPEAN KNIFE	1 DOZ.
FL-852290	5 PC. SETTING, EURO	1 EA.
FL-852299	5 PC. SETTING, US	1 EA.



**JUILLIARD (18/10 STAINLESS)**  
SOLD IN CASE PACKS OF DOZEN.

		CASE PACK
FL-2201	TEASPOON	3 DOZ.
FL-2203	SERVING SPOON	1 DOZ.
FL-2204	ICED TEASPOON	3 DOZ.
FL-2205	DINNER FORK	3 DOZ.
FL-2206	SALAD FORK	3 DOZ.
FL-2207	DESSERT SPOON	3 DOZ.
FL-2208	ROUND BOWL SOUP SPOON	3 DOZ.
FL-2210	BUTTER SPREADER, 1 PC.	1 DOZ.
FL-2211	BUTTER KNIFE, 1 PC.	1 DOZ.
FL-2212	BOUILLON SPOON	3 DOZ.
FL-2215	COCKTAIL FORK	3 DOZ.
FL-2225	DINNER KNIFE, H.H.	1 DOZ.
FL-2229	A.D. COFFEE SPOON	3 DOZ.
FL-2245	DINNER KNIFE, 1 PC.	3 DOZ.
FL-22051	EUROPEAN FORK	3 DOZ.
FL-22451	STEAK KNIFE, H.H.	1 DOZ.

**MASTABA (18/10 STAINLESS)**

SHOWING THAT YOU CAN PUT A MODERN SPIN ON TRADITIONAL FLATWARE, MASTABA HAS A UNIQUE LINED PATTERN WITH A TRADITIONAL SHAPE. SOLD BY THE DOZEN ONLY.



		CASE PACK
FL-25501	TEASPOON	1 DOZ.
FL-25503	SERVING SPOON	1 DOZ.
FL-25504	ICED TEASPOON	1 DOZ.
FL-25505	DINNER FORK	1 DOZ.
FL-255051	EURO DINNER FORK	1 DOZ.
FL-25506	SALAD FORK	1 DOZ.
FL-25507	DESSERT SPOON	1 DOZ.
FL-25511	SH BUTTER KNIFE	1 DOZ.
FL-25512	BOUILLON SPOON	1 DOZ.
FL-25515	COCKTAIL FORK	1 DOZ.
FL-25529	DEMI SPOON	1 DOZ.
FL-25545	DINNER KNIFE	1 DOZ.
FL-255451	EURO. DINNER KNIFE	1 DOZ.
FL-25590	EUROPEAN 5 PIECE SET	1 EA.
FL-25599	AMERICAN 5 PIECE SET	1 EA.



**ETERNAL (STAINLESS STEEL)**  
SOLD IN CASE PACKS OF DOZEN.

		CASE PACK
FL-9827001	TEASPOON, 6.5" L.	1 DOZ.
FL-9827005	DINNER FORK, 8" L.	1 DOZ.
FL-9827006	SALAD FORK, 7.25" L.	1 DOZ.
FL-9827007	DESSERT SPOON, 7" L.	1 DOZ.
FL-9827045	DINNER KNIFE, 9.25" L.	1 DOZ.



**ROCKWOOD (18/10 STAINLESS)**  
THE ROCKWOOD PATTERN IS A TEXTURED DESIGN THAT HAS THE LOOK OF STONE. SOLD BY THE DOZEN ONLY.

		CASE PACK
FL-86901	TEASPOON	1 DOZ.
FL-86905	DINNER FORK	1 DOZ.
FL-86906	SALAD FORK	1 DOZ.
FL-86907	DESSERT SPOON	1 DOZ.
FL-86945	DINNER KNIFE	1 DOZ.



TEL: 508-892-9618

FAX: 508-892-9745

PRICES AVAILABLE AT WWW.CATERERSWAREHOUSE.COM



NEEDLEPOINT (18/10 STAINLESS)

SOLD IN CASE PACKS OF DOZEN.

	CASE PACK
FL-254401	TEASPOON 3 DOZ.
FL-254403	TABLE/SERVING SPOON 1 DOZ.
FL-254404	ICED TEA SPOON 3 DOZ.
FL-254405	DINNER FORK 3 DOZ.
FL-254406	SALAD FORK 3 DOZ.
FL-254407	DESSERT SPOON 3 DOZ.
FL-254411	BUTTER KNIFE, F.H. 1 DOZ.
FL-254412	BOUILLON SPOON 3 DOZ.
FL-254415	COCKTAIL FORK 3 DOZ.
FL-254445	1-PC DINNER KNIFE 3 DOZ.



ONEIDA®  
STANFORD (18/0 STAINLESS)

SOLD IN CASE PACKS OF DOZEN.

	CASE PACK
FL-1251506	SALAD/DESSERT FORK 3 DOZ.
FL-1251510	TEASPOON 3 DOZ.
FL-1251520	DESSERT SPOON 3 DOZ.
FL-1251530	BOUILLON SPOON 3 DOZ.
FL-1251570	DEMITASSE SPOON 3 DOZ.
FL-1251610	DINNER FORK 3 DOZ.
FL-1251710	KNIFE, 1 PC. 3 DOZ.

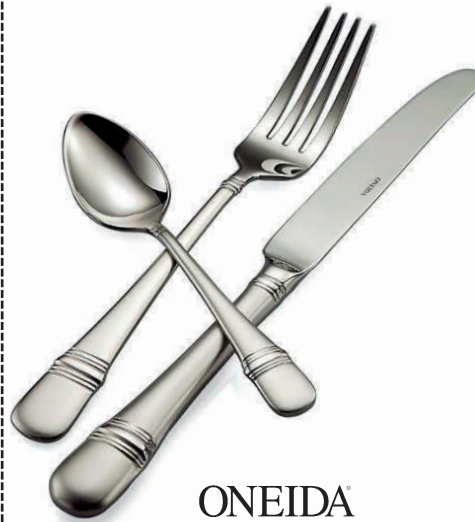

ASTRAGAL (SILVERPLATE)

SOLD IN CASE PACKS OF DOZEN.

	CASE PACK
FL-600601	TEASPOON 3 DOZ.
FL-600603	SERVING/TABLE SPOON 3 DOZ.
FL-600604	ICED TEA SPOON 3 DOZ.
FL-600605	DINNER FORK 3 DOZ.
FL-600606	SALAD FORK 3 DOZ.
FL-600607	DESSERT SPOON 3 DOZ.
FL-600608	ROUND BOWL SOUP SPOON 3 DOZ.
FL-600611	BUTTER KNIFE, F.H. 3 DOZ.
FL-600615	OYSTER/COCKTAIL FORK 3 DOZ.
FL-600629	DEMITASSE SPOON 3 DOZ.
FL-600645	DINNER KNIFE, 1 PC. 3 DOZ.

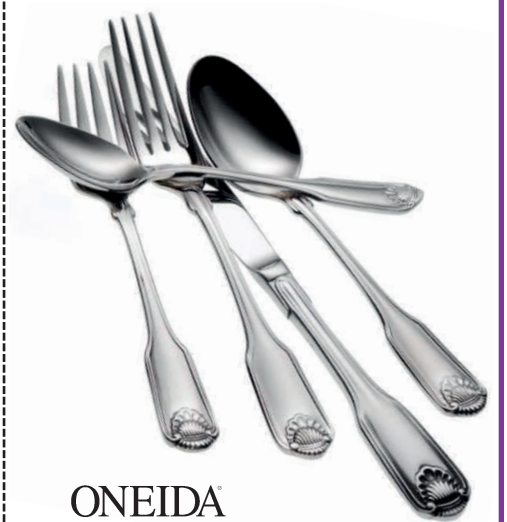

ONEIDA®  
CLASSIC SHELL (18/10 STAINLESS)

SOLD IN CASE PACKS OF DOZEN.

	CASE PACK
FL-246930	TEASPOON 3 DOZ.
FL-246932	DESSERT SPOON 3 DOZ.
FL-246933	BOUILLON SPOON 3 DOZ.
FL-246935	ICED TEA SPOON 3 DOZ.
FL-246936	DEMITASSE SPOON 3 DOZ.
FL-246937	TABLE/SERVING SPOON 1 DOZ.
FL-246938	DINNER FORK 3 DOZ.
FL-246940	SALAD/DESSERT FORK 3 DOZ.
FL-246941	COCKTAIL FORK 3 DOZ.
FL-246942	DINNER/DESSERT KNIFE,S.H. 1 DOZ.



ONEIDA®  
SHAKER (18/0 STAINLESS)

SOLD IN CASE PACKS OF DOZEN.

	CASE PACK
FL-56001	TEASPOON 1 DOZ.
FL-56003	TABLESPOON/SERVING SPOON 1 DOZ.
FL-56004	ICED TEASPOON 1 DOZ.
FL-56005	DINNER FORK 1 DOZ.
FL-56006	SALAD/DESSERT FORK 1 DOZ.
FL-56007	OVAL BOWL SOUP/DESSERT SPOON 1 DOZ.
FL-56012	BOUILLON SPOON 1 DOZ.
FL-56015	OYSTER/COCKTAIL FORK 1 DOZ.
FL-56029	A.D. COFFEE SPOON 1 DOZ.
FL-56045	DINNER KNIFE 1 DOZ.
FL-560011	TEASPOON, EUROPEAN SIZE 1 DOZ.
FL-560051	TABLE FORK, EUROPEAN SIZE 1 DOZ.



ONEIDA®  
GLISSADE (18/0 STAINLESS)

SOLD IN CASE PACKS OF DOZEN.

	CASE PACK
FL-59001	TEASPOON 1 DOZ.
FL-59003	TABLESPOON/SERVING SPOON 1 DOZ.
FL-59004	ICED TEASPOON 1 DOZ.
FL-59005	DINNER FORK 1 DOZ.
FL-59006	SALAD/DESSERT FORK 1 DOZ.
FL-59007	OVAL BOWL SOUP/DESSERT SPOON 1 DOZ.
FL-59012	BOUILLON SPOON 1 DOZ.
FL-59015	OYSTER/COCKTAIL FORK 1 DOZ.
FL-59029	A.D. COFFEE SPOON 1 DOZ.
FL-59045	DINNER KNIFE 1 DOZ.
FL-590011	TEASPOON, EUROPEAN SIZE 1 DOZ.
FL-590051	TABLE FORK, EUROPEAN SIZE 1 DOZ.

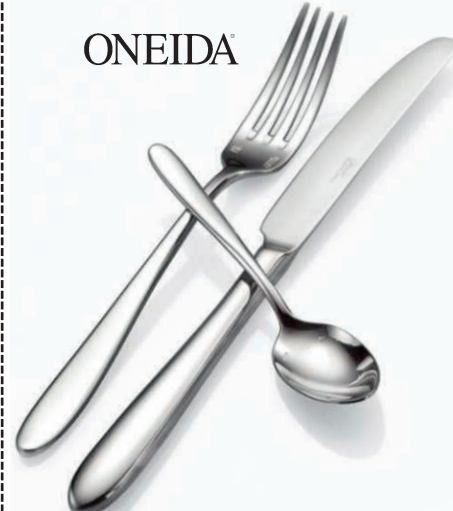

ONEIDA®  
MASCAGNI II (18/0 STAINLESS)

SOLD IN CASE PACKS OF DOZEN.

	CASE PACK
FL-57001	TEASPOON, US SIZE 1 DOZ.
FL-57003	TABLESPOON/SERVING SPOON 1 DOZ.
FL-57004	ICED TEASPOON 1 DOZ.
FL-57007	OVAL BOWL SOUP/DESSERT SPOON 1 DOZ.
FL-57010	BUTTER SPREADER, 1-PC. 1 DOZ.
FL-57012	ROUND BOWL SOUP SPOON 1 DOZ.
FL-57014	FISH FORK, 7" 1 DOZ.
FL-57022	STEAK KNIFE, 1-PC. 1 DOZ.
FL-57029	A.D. COFFEE SPOON, 1 DOZ.
FL-57039	FISH KNIFE, 1-PC. 1 DOZ.
FL-57045	TABLE KNIFE 1 DOZ.
FL-570011	TEASPOON, EUROPEAN SIZE 1 DOZ.



ONEIDA®  
TITIAN (18/0 STAINLESS)

SOLD IN CASE PACKS OF DOZEN.

	CASE PACK
FL-55001	TEASPOON, US SIZE 1 DOZ.
FL-55003	TABLESPOON/SERVING SPOON 1 DOZ.
FL-55004	ICED TEASPOON 1 DOZ.
FL-55006	SALAD/DESSERT FORK 1 DOZ.
FL-55007	OVAL BOWL SOUP/DESSERT SPOON 1 DOZ.
FL-55010	BUTTER SPREADER, 1-PC. 1 DOZ.
FL-55012	ROUND BOWL SOUP SPOON 1 DOZ.
FL-55014	FISH FORK 1 DOZ.
FL-55015	OYSTER/COCKTAIL FORK 1 DOZ.
FL-55022	STEAK KNIFE, 1-PC. 1 DOZ.
FL-55029	A.D. COFFEE SPOON 1 DOZ.
FL-55039	FISH KNIFE, 1-PC. 1 DOZ.
FL-55045	TABLE KNIFE, 9.5" 1 DOZ.
FL-550011	TEASPOON, EUROPEAN SIZE 1 DOZ.
FL-550051	TABLE FORK, EUROPEAN SIZE 1 DOZ.



METEOR (STAINLESS)

MADE OF STAINLESS STEEL, METEOR HAS A GREAT FINISH WITH A SMALL CONTEMPORARY DESIGN AT THE BOTTOM. SOLD IN CASE PACKS OF DOZEN.

	CASE PACK
FL-7001	TEASPOON 3 DOZ.
FL-7003	SERVING SPOON 2 DOZ.
FL-7004	ICED TEA SPOON 2 DOZ.
FL-7005	DINNER FORK 2 DOZ.
FL-70051	TABLE FORK 1 DOZ.
FL-7006	SALAD FORK 2 DOZ.
FL-7007	DESSERT SPOON 2 DOZ.
FL-7010	BUTTER KNIFE 2 DOZ.
FL-7012	BOUILLON SPOON 2 DOZ.
FL-7015	COCKTAIL FORK 2 DOZ.
FL-7025	TABLE KNIFE, H.H. 1 DOZ.
FL-7029	DEMI SPOON 2 DOZ.
FL-7038	LARGE BOWL 2 DOZ.
FL-7045	1 PC. DINNER KNIFE 1 DOZ.
FL-7099	5 PC. SETTING, US 1 EA.



ONEIDA®  
ACCLIVITY (18/0 STAINLESS STEEL)

SOLD IN CASE PACKS OF DOZEN.

	CASE PACK
FL-88201	TEASPOON 1 DOZ.
FL-88203	TABLESPOON/SERVING SPOON 1 DOZ.
FL-88204	ICED TEASPOON 1 DOZ.
FL-88205	DINNER FORK 1 DOZ.
FL-88206	SALAD/DESSERT FORK 1 DOZ.
FL-88207	OVAL BOWL SOUP/DESSERT SPOON 1 DOZ.
FL-88215	OYSTER/COCKTAIL FORK 1 DOZ.
FL-88229	A.D. COFFEE SPOON 1 DOZ.
FL-882011	TEASPOON, EUROPEAN SIZE 1 DOZ.
FL-882051	TABLE FORK, EUROPEAN SIZE 1 DOZ.
FL-882451	DINNER KNIFE, 1 PC." 1 DOZ.



**VOGUE (MIRROR FINISH 18/10 STAINLESS)**  
SOLD IN CASE PACKS OF DOZEN.

STAINLESS	PEWALUM	CASE PACK
FL-2501	FL-2501	TEASPOON 1 DOZ.
FL-2503	FL-2503	SERVING SPOON 1 DOZ.
FL-2504	FL-2504	ICED TEA SPOON 1 DOZ.
FL-2505	FL-2505	DINNER FORK 1 DOZ.
FL-2506	FL-2506	SALAD FORK 1 DOZ.
FL-2507	FL-2507	DESSERT SPOON 1 DOZ.
FL-2511	FL-2511	BUTTER KNIFE, S.H. 1 DOZ.
FL-2512	FL-2512	BOUILLON SPOON 1 DOZ.
FL-2515	FL-2515	COCKTAIL FORK 1 DOZ.
FL-2522	FL-2522	STEAK KNIFE 1 DOZ.
FL-2529	FL-2529	DEMITASSE SPOON 1 DOZ.
FL-2545	FL-2545	KNIFE, 1 PC. 1 DOZ.
FL-25051	FL-25051	EUROPEAN FORK 1 DOZ.
FL-25451	FL-25451	EUROPEAN KNIFE 1 DOZ.
FL-2590	FL-2590	5 PC. SETTING, EURO 1 EA.
FL-2599	FL-2599	5 PC. SETTING, US 1 EA.

**FROSTED** CASE PACK

FL-S2501	TEASPOON 1 DOZ.
FL-S2503	SERVING SPOON 1 DOZ.
FL-S2504	ICED TEA SPOON 1 DOZ.
FL-S2505	DINNER FORK 1 DOZ.
FL-S2506	SALAD FORK 1 DOZ.
FL-S2507	DESSERT SPOON 1 DOZ.
FL-S2511	BUTTER KNIFE, S.H. 1 DOZ.
FL-S2512	BOUILLON SPOON 1 DOZ.
FL-S2515	COCKTAIL FORK 1 DOZ.
FL-S2522	STEAK KNIFE 1 DOZ.
FL-S2529	DEMITASSE SPOON 1 DOZ.
FL-S2545	KNIFE, 1 PC. 1 DOZ.
FL-S25051	EUROPEAN FORK 1 DOZ.
FL-S25451	EUROPEAN KNIFE 1 DOZ.
FL-S2590	5 PC. SETTING, EURO 1 EA.
FL-S2599	5 PC. SETTING, US 1 EA.



**SEMI (18/10 STAINLESS)**  
SOLD IN CASE PACKS OF DOZEN.

STAINLESS	PEWALUM	CASE PACK
FL-0901	FL-0901PW	TEASPOON 1 DOZ.
FL-0903	FL-0903PW	SERVING SPOON 1 DOZ.
FL-0904	FL-0904PW	ICED TEA SPOON 1 DOZ.
FL-0905	FL-0905PW	DINNER FORK 1 DOZ.
FL-09051	FL-09051PW	TABLE FORK 1 DOZ.
FL-0906	FL-0906PW	SALAD FORK 1 DOZ.
FL-0907	FL-0907PW	DESSERT SPOON 1 DOZ.
FL-0911	FL-0911PW	BUTTER KNIFE 1 DOZ.
FL-0912	FL-0912PW	BOUILLON SPOON 1 DOZ.
FL-0923	FL-0923PW	STEAK KNIFE 1 DOZ.
FL-0929	FL-0929PW	DEMI SPOON 1 DOZ.
FL-0945	FL-0945PW	DINNER KNIFE 1 DOZ.
FL-0999	FL-0999PW	5 PC. SETTING, US 1 EA.



**STAR (18/10 STAINLESS)**  
SOLD IN CASE PACKS OF DOZEN.

STAINLESS	PEWALUM	CASE PACK
FL-0801	FL-0801PW	TEASPOON 1 DOZ.
FL-0805	FL-0805PW	DINNER FORK 1 DOZ.
FL-08051	FL-08051PW	TABLE FORK 1 DOZ.
FL-0806	FL-0806PW	SALAD FORK 1 DOZ.
FL-0807	FL-0807PW	DESSERT SPOON 1 DOZ.
FL-0810	FL-0810PW	BUTTER SPREADER 1 DOZ.
FL-0812	FL-0812PW	BOUILLON SPOON 1 DOZ.
FL-0815	FL-0815PW	COCKTAIL FORK 1 DOZ.
FL-0829	FL-0829PW	DEMI SPOON 1 DOZ.
FL-08451	FL-08451PW	TABLE KNIFE 1 DOZ.
FL-0899	FL-0899PW	5 PC. SETTING, US 1 EA.



**ERIK (18/10 STAINLESS)**  
SOLD IN CASE PACKS OF DOZEN.

STAINLESS	PEWALUM	CASE PACK
FL-851201	FL-851201PW	TEASPOON 1 DOZ.
FL-851204	FL-851204PW	ICED TEASPOON 1 DOZ.
FL-851205	FL-851205PW	DINNER FORK 1 DOZ.
FL-8512051	FL-8512051PW	EURO TABLE FORK 1 DOZ.
FL-851206	FL-851206PW	SALAD FORK 1 DOZ.
FL-851207	FL-851207PW	DESSERT SPOON 1 DOZ.
FL-851211	FL-851211PW	BUTTER SPREAD 1 DOZ.
FL-851212	FL-851212PW	BOUILLON SPOON 1 DOZ.
FL-851245	FL-851245PW	DINNER KNIFE 1 DOZ.
FL-8512451	FL-8512451PW	TABLE KNIFE 1 DOZ.
FL-521290	FL-52129PW	5 PC. SETTING, EURO 1 EA.
FL-521299	FL-521299PW	5 PC. SETTING, US 1 EA.



**IRONSTONE (18/10 STAINLESS)**  
SOLD IN CASE PACKS OF DOZEN.

STAINLESS	PEWALUM	CASE PACK
FL-6301	FL-6301PW	TEASPOON 1 DOZ.
FL-6303	FL-6303PW	SERVING SPOON 1 DOZ.
FL-6304	FL-6304PW	ICED TEA SPOON 1 DOZ.
FL-6305	FL-6305PW	DINNER FORK 1 DOZ.
FL-6306	FL-6306PW	SALAD FORK 1 DOZ.
FL-6307	FL-6307PW	DESSERT SPOON 1 DOZ.
FL-6311	FL-6307PW	BUTTER KNIFE, S.H. 1 DOZ.
FL-6312	FL-6312PW	BOUILLON SPOON 1 DOZ.
FL-6315	FL-6315PW	COCKTAIL FORK 1 DOZ.
FL-6322	FL-6322PW	STEAK KNIFE 1 DOZ.
FL-6329	FL-6329PW	DEMITASSE SPOON 1 DOZ.
FL-6345	FL-6345PW	KNIFE, 1 PIECE 1 DOZ.
FL-63051	FL-63051PW	EUROPEAN FORK 1 DOZ.
FL-63451	FL-63451PW	EUROPEAN KNIFE 1 DOZ.
FL-6390	FL-6390PW	5 PC. SETTING, EURO 1 EA.
FL-6399	FL-6399PW	5 PC. SETTING, US 1 EA.

**WANT TO TURN AN OLD FLATWARE PATTERN INTO SOMETHING NEW?**

FLATWARE REFURBISHING GIVES CURRENT STOCK A NEW FLATWARE LOOK. THIS PROCESS CAN BE USED TO TURN ANY 18/8 OR 18/10 NON-MAGENTISED STAINLESS STEEL PATTERN, SILVERPLATE OR GOLDPLATE PATTERN INTO A NEW SILVERPLATED OR GOLDPLATED OFFERING. THIS PROCESS GIVES THE LOOK OF NEW AT A FRACTION OF THE COST.

- 1) THERE IS A 20 DOZEN PIECE MIXED MINIMUM
- 2) SEND US A SAMPLE PIECE OF YOUR CURRENT FLATWARE TO INSPECT, TEST, AND DETERMINE IF THE MINIMUM QUALITY REQUIREMENTS TO REFURBISH ARE MET.
- 3) ONCE INSPECTED AND APPROVED YOUR ORDER WILL BE PRODUCED WITHIN 14 DAYS ON AVERAGE.



**HAMMERED HANDLE DESIGN**

- 11" L. SOLID SERVING SPOON
- 9.5" L. WIDE BOTTOM SPOON
- 9.5" PASTRY SERVER
- 13.25" LONG HANDLE SPOON
- 13.25" LONG HANDLE SLOTTED SPOON
- 1 OZ., 12.25" L. SAUCE LADLE WITH SPOUT

**IRONSTONE BUFFETWARE**  
MATCHES IRONSTONE FLATWARE.

18/10 STAINLESS	SILVERPLATED	GOLDPLATED
FL-63011	FL-63011SP	FL-63011GP
FL-63012	FL-63012SP	FL-63012GP
FL-63013	FL-63013SP	FL-63013GP
FL-63014	FL-63014SP	FL-63014GP
FL-63015	FL-63015SP	FL-63015GP
FL-63016	FL-63016SP	FL-63016GP



**18/10 STAINLESS**

- 11" L. CARVING KNIFE
- 10.5" L. DEEP BOWL SPOON
- 11.75" L., 4 OZ. SOUP LADLE
- 13" L. LONG HANDLED SPOON
- 13" L. LONG HANDLED SLOTTED SPOON
- 9.5" L. WIDE BOWL SPOON
- 10.5" L. MEAT FORK
- 9.5" L. PASTRY SERVER

**ULTRA BUFFETWARE (18/10 STAINLESS STEEL)**

MATCHES ULTRA FLATWARE.

18/10 STAINLESS	SILVERPLATED	GOLDPLATED
ACSS-6687	ACSS-6687SP	ACSS-6687GP
ACSS-6690	ACSS-6690SP	ACSS-6690GP
ACSS-6691	ACSS-6691SP	ACSS-6691GP
ACSS-6693	ACSS-6693SP	ACSS-6693GP
ACSS-6694	ACSS-6694SP	ACSS-6694GP
ACSS-6695	ACSS-6695SP	ACSS-6695GP
ACSS-6696	ACSS-6696SP	ACSS-6696GP
ACSS-6699	ACSS-6699SP	ACSS-6699GP

SILVERPLATED	GOLDPLATED
ACSS-6687SP	ACSS-6687GP
ACSS-6690SP	ACSS-6690GP
ACSS-6691SP	ACSS-6691GP
ACSS-6693SP	ACSS-6693GP
ACSS-6694SP	ACSS-6694GP
ACSS-6695SP	ACSS-6695GP
ACSS-6696SP	ACSS-6696GP
ACSS-6699SP	ACSS-6699GP

18/10 STAINLESS STEEL, SILVERPLATE, GOLD FLATWARE, AND PEWALUM

BEST SELLERS!



CLASSIC BEAD



LANCER



ULTRA



PRIM



CHALET



LUXOR



SENTRY



\*MINIMUM ORDER OF 20 DOZEN MIXED FOR SILVERPLATING, GOLDPLATING, OR PEWALUM.

ADD SYMBOL AFTER #  
GP=GOLDPLATE FINISH  
SP=SILVERPLATE FINISH  
PW=PEWALUM FINISH  
EXAMPLE: FL-9201GP  
FL-9201SP  
FL-9201PW

	CLASSIC BEAD	LANCER	CHALET	ULTRA	SENTRY	PRIM	LUXOR	CASE
TEASPOON	FL-9201	FL-9401	FL-9801	FL-9601	FL-9501	FL-9701	FL-9301	3 DOZ.
SERVING SPOON	FL-9203	FL-9403	FL-9803	FL-9603	FL-9503	FL-9703	FL-9303	2 DOZ.
ICED TEA SPOON	FL-9204	FL-9404	FL-9804	FL-9604	FL-9504	FL-9704	FL-9304	2 DOZ.
DINNER FORK	FL-9205	FL-9405	FL-9805	FL-9605	FL-9505	FL-9705	FL-9305	2 DOZ.
EUROPEAN FORK	FL-92051	FL-94051	FL-98051	FL-96051	FL-95051	FL-97051	FL-93051	2 DOZ.
SALAD FORK	FL-9206	FL-9406	FL-9806	FL-9606	FL-9506	FL-9706	FL-9306	2 DOZ.
DESSERT SPOON	FL-9207	FL-9407	FL-9807	FL-9607	FL-9507	FL-9707	FL-9307	2 DOZ.
BUTTER SPREADER	N/A	FL-9410	FL-9810	FL-9610	FL-9510	FL-9710	FL-9310	2 DOZ.
BUTTER KNIFE, S.H.	FL-9211	N/A	FL-9811	FL-9611	FL-9511	FL-9711	N/A	1 DOZ.
BOUILLON SPOON	FL-9212	FL-9412	FL-9812	FL-9612	FL-9512	FL-9712	FL-9312	2 DOZ.
FISH FORK	N/A	N/A	N/A	FL-9614	FL-9514	FL-9714	N/A	2 DOZ.
COCKTAIL FORK	FL-9215	FL-9415	FL-9815	FL-9615	FL-9515	FL-9715	FL-9315	2 DOZ.
COLD MEAT FORK	N/A	N/A	N/A	FL-9617	FL-9517	N/A	N/A	2 DOZ.
GRAVY LADLE	N/A	N/A	N/A	FL-9621	FL-9521	N/A	N/A	2 DOZ.
STEAK KNIFE, S.H.	FL-9222	FL-9422	N/A	FL-9622	FL-9522	FL-9722	N/A	2 DOZ.
KNIFE, H.H.	FL-9225	FL-9425	FL-9825	FL-9625	FL-9525	N/A	N/A	1 DOZ.
PIERCED SERVING SPOON	N/A	N/A	N/A	FL-9628	FL-9528	N/A	N/A	2 DOZ.
DEMITASSE SPOON	FL-9229	FL-9429	FL-9829	FL-9629	FL-9529	FL-9729	FL-9329	2 DOZ.
FISH KNIFE	N/A	N/A	N/A	FL-9639	FL-9539	FL-9739	N/A	1 DOZ.
KNIFE, 1 PIECE	FL-9245	FL-9445	FL-9845	FL-9645	FL-9545	FL-9745	FL-9345	2 DOZ.
EUROPEAN KNIFE	FL-92451	FL-94451	FL-98451	FL-96451	FL-95451	FL-97451	FL-93451	1 DOZ.
EUROPEAN, 5 PC SET	FL-9290	FL-9490	FL-9890	FL-9690	FL-9590	FL-9790	FL-9390	1 EA.
AMERICAN, 5 PC SET	FL-9299	FL-9499	FL-9899	FL-9699	FL-9599	FL-9799	FL-9399	1 EA.

\*\*PEWALUM IN AN APPLICATION THAT GIVES FLATWARE PATTERNS A UNIQUE BRUSHED FINISH. ONCE APPLIED THE RESULT IS A SATIN ANTIQUE PEWTER WASH LOOK.



(LANCER STAINLESS)



(LANCER PEWALUM)

EUROPEAN 5 PC SET: TEASPOON, EUROPEAN FORK, SALAD FORK, DESSERT SPOON, EUROPEAN KNIFE  
AMERICAN 5 PC SET: TEASPOON, DINNER FORK, SALAD FORK, DESSERT SPOON, 1 PIECE KNIFE



**CHARRED (18/10 STAINLESS)**  
A SATIN FINISH WITH A BLACK CHECKER BOARD.  
SOLD IN CASE PACKS OF DOZEN.

		CASE PACK
FL-1601	TEASPOON	1 DOZ.
FL-1603	SERVING SPOON	1 DOZ.
FL-1605	DINNER FORK	1 DOZ.
FL-1606	SALAD FORK	1 DOZ.
FL-1607	DESSERT SPOON	1 DOZ.
FL-1611	BUTTER KNIFE, S.H.	1 DOZ.
FL-1612	BOUILLON SPOON	1 DOZ.
FL-1615	COCKTAIL FORK	1 DOZ.
FL-1629	DEMITASSE SPOON	1 DOZ.
FL-1645	KNIFE, 1 PC.	1 DOZ.
FL-1699	5 PC. SETTING, US	1 EA.



**RIPTIDE (18/10 STAINLESS)**  
BRIGHT FINISH. SOLD IN CASE PACKS OF DOZEN.

		CASE PACK
FL-1201	TEASPOON	1 DOZ.
FL-1203	SERVING SPOON	1 DOZ.
FL-1205	DINNER FORK	1 DOZ.
FL-1206	SALAD FORK	1 DOZ.
FL-1207	DESSERT SPOON	1 DOZ.
FL-1211	BUTTER KNIFE	1 DOZ.
FL-1212	BOUILLON SPOON	1 DOZ.
FL-1215	COCKTAIL FORK	1 DOZ.
FL-1229	DEMITASSE SPOON	1 DOZ.
FL-1245	KNIFE, 1 PC.	1 DOZ.
FL-1299	5 PC. SETTING, US	1 EA.



**DISCRETION (18/0 STAINLESS)**  
HEAVYWEIGHT. SOLD IN CASE PACKS OF DOZEN.

		CASE PACK
FL-6501	TEASPOON	3 DOZ.
FL-6503	SERVING SPOON	2 DOZ.
FL-6504	ICED TEA SPOON	2 DOZ.
FL-6505	DINNER FORK	2 DOZ.
FL-6506	SALAD FORK	2 DOZ.
FL-6507	DESSERT SPOON	2 DOZ.
FL-6510	BUTTER SPREADER	2 DOZ.
FL-6512	BOUILLON SPOON	2 DOZ.
FL-6515	COCKTAIL FORK	2 DOZ.
FL-6545	KNIFE, 1 PC.	1 DOZ.
FL-65945	5 PC. SETTING, US	1 EA.



**SWIRL (18/0 STAINLESS)**  
HEAVYWEIGHT. SOLD IN CASE PACKS OF DOZEN.

		CASE PACK
FL-6601	TEASPOON	3 DOZ.
FL-6604	ICED TEA SPOON	2 DOZ.
FL-6605	DINNER FORK	2 DOZ.
FL-6606	SALAD FORK	2 DOZ.
FL-6607	DESSERT SPOON	2 DOZ.
FL-6611	BUTTER KNIFE	1 DOZ.
FL-6612	BOUILLON SPOON	2 DOZ.
FL-6615	COCKTAIL FORK	2 DOZ.
FL-6629	DEMITASSE SPOON	2 DOZ.
FL-6645	KNIFE, 1 PC.	1 DOZ.
FL-6699	5 PC. SETTING, US	1 EA.



**DERBY (18/0 STAINLESS)**  
SOLD IN CASE PACKS OF DOZEN.

		CASE PACK
FL-4701	TEASPOON	3 DOZ.
FL-4704	ICED TEA SPOON	2 DOZ.
FL-4705	DINNER FORK	2 DOZ.
FL-4706	SALAD FORK	2 DOZ.
FL-4707	DESSERT SPOON	2 DOZ.
FL-4712	BOUILLON SPOON	2 DOZ.
FL-4715	COCKTAIL FORK	2 DOZ.
FL-4745	KNIFE, 1 PC.	1 DOZ.
FL-4799	5 PC. SETTING	1 EA.



**OLD COUNTRY (18/0 STAINLESS)**  
SOLD IN CASE PACKS OF DOZEN.

		CASE PACK
FL-7601	TEASPOON	3 DOZ.
FL-7603	SERVING SPOON	2 DOZ.
FL-7604	ICED TEA SPOON	2 DOZ.
FL-7605	DINNER FORK	2 DOZ.
FL-7606	SALAD FORK	2 DOZ.
FL-7607	DESSERT SPOON	2 DOZ.
FL-7612	BOUILLON SPOON	2 DOZ.
FL-7615	COCKTAIL FORK	2 DOZ.
FL-7645	KNIFE, 1 PC.	1 DOZ.
FL-7699	5 PC. SETTING, US	1 EA.



**MONTEREY (18/0 STAINLESS)**  
SOLD IN CASE PACKS OF DOZEN.

		CASE PACK
FL-2901	TEASPOON	3 DOZ.
FL-2903	SERVING SPOON	2 DOZ.
FL-2904	ICED TEA SPOON	2 DOZ.
FL-2905	DINNER FORK	2 DOZ.
FL-2906	SALAD FORK	2 DOZ.
FL-2907	DESSERT SPOON	2 DOZ.
FL-2912	BOUILLON SPOON	2 DOZ.
FL-2915	COCKTAIL FORK	2 DOZ.
FL-2945	KNIFE, 1 PC.	1 DOZ.
FL-2999	5 PC. SETTING, US	1 EA.



**FARMINGTON (18/10 STAINLESS)**  
BRUSHED FINISH. FEATURES THICK AND HEAVY DUTY FORGED HANDLES. SOLD IN CASE PACKS OF DOZEN.

		CASE PACK
FL-5301	TEASPOON	1 DOZ.
FL-5304	ICED TEA SPOON	1 DOZ.
FL-5305	DINNER FORK	1 DOZ.
FL-5307	DESSERT SPOON	1 DOZ.
FL-5311	BUTTER KNIFE, S.H.	1 DOZ.
FL-5312	BOUILLON SPOON	1 DOZ.
FL-5315	COCKTAIL FORK	1 DOZ.
FL-53051	EUROPEAN DINNER FORK	1 DOZ.
FL-53451	EUROPEAN KNIFE, S.H.	1 DOZ.
FL-5390	5 PC. SETTING, EURO	1 EA.



**BARONY (18/0 STAINLESS)**  
HEAVYWEIGHT. SOLD IN CASE PACKS OF DOZEN.

		CASE PACK
FL-9001	TEASPOON	3 DOZ.
FL-9003	SERVING SPOON	2 DOZ.
FL-9004	ICED TEA SPOON	2 DOZ.
FL-9005	DINNER FORK	2 DOZ.
FL-90051	EURO. DINNER FORK	2 DOZ.
FL-9006	SALAD FORK	2 DOZ.
FL-9007	DESSERT SPOON	2 DOZ.
FL-9011	BUTTER SPREADER	2 DOZ.
FL-9012	BOUILLON SPOON	2 DOZ.
FL-9015	COCKTAIL FORK	2 DOZ.
FL-9045	KNIFE, 1 PC.	1 DOZ.
FL-9099	5 PC. SETTING	1 EA.



**PACIFIC RIM (18/10 STAINLESS)**  
EXTRA HEAVYWEIGHT. SOLD IN CASE PACKS OF DOZEN.

		CASE PACK
FL-314	TEASPOON	3 DOZ.
FL-315	DINNER FORK	2 DOZ.
FL-317	SALAD FORK	2 DOZ.
FL-317L	LARGE SALAD FORK	2 DOZ.
FL-318	DESSERT SPOON	2 DOZ.
FL-319	BOUILLON SPOON	2 DOZ.
FL-320	BUTTER KNIFE, S.H., 1 PC.	1 DOZ.
FL-321	COCKTAIL FORK	2 DOZ.
FL-322	KNIFE, S.H., 1 PC.	1 DOZ.
FL-323	EURO. KNIFE, S.H., 1 PC.	1 DOZ.
FL-324	SERVING SPOON	1 DOZ.
FL-325	ICED TEASPOON	2 DOZ.
FL-326	BOUILLON SPOON	2 DOZ.
FL-327	SMALL KNIFE	1 DOZ.
FL-328	DEMI SPOON	2 DOZ.
FL-390	5 PC. SETTING, EURO	1 EA.
FL-399	5 PC. SETTING, US	1 EA.



STANFORDD (18/8 STAINLESS) MIRROR FINISH. EXTRA HEAVYWEIGHT. SOLD IN CASE PACKS OF DOZEN.

		CASE PACK
FL-003401	6" TEASPOON	1 DOZ.
FL-003402	7 5/16" ICED TEA SPOON	1 DOZ.
FL-003403	7 1/8" DINNER SPOON	1 DOZ.
FL-003404	6 15/16" BOUILLON SPOON	1 DOZ.
FL-003405	7 1/8" DINNER FORK	1 DOZ.
FL-003406	5 7/8" SALAD FORK	1 DOZ.
FL-003407	5 7/16" OYSTER FORK	1 DOZ.
FL-003408	9" DINNER KNIFE	1 DOZ.
FL-003409	4 3/8" DEMITASSE SPOON	1 DOZ.
FL-003410	8 5/8" TABLE SPOON, EURO.	1 DOZ.
FL-003411	8 1/4" TABLE FORK, EURO.	1 DOZ.
FL-003412	6 5/8" BUTTER SPREADER	1 DOZ.
FL-003415	8 3/4" DINNER KNIFE, HOLLOW HANDLE	1 DOZ.
FL-003418	9 5/8" TABLE KNIFE, HOLLOW HANDLE	1 DOZ.
FL-0034051	7 1/4" EXTENDED LENGTH DINNER FORK	1 DOZ.
FL-0034061	6 7/8" EXTENDED LENGTH SALAD FORK	1 DOZ.



VICTORIA (18/10 STAINLESS) SOLD IN CASE PACKS OF DOZEN.

		CASE PACK
FL-003501	TEASPOON	1 DOZ.
FL-003502	ICED TEA SPOON	1 DOZ.
FL-003503	DINNER SPOON	1 DOZ.
FL-003504	BOUILLON SPOON	1 DOZ.
FL-003505	DINNER FORK	1 DOZ.
FL-003506	SALAD FORK	1 DOZ.
FL-003507	OYSTER FORK	1 DOZ.
FL-003508	DINNER KNIFE	1 DOZ.
FL-003509	DEMITASSE SPOON	1 DOZ.
FL-003510	TABLE SPOON, EURO.	1 DOZ.
FL-003511	TABLE FORK, EURO.	1 DOZ.
FL-003512	BUTTER SPREADER	1 DOZ.



DELUXE PEARL (18/8 STAINLESS) EXTRA HEAVY WEIGHT. SOLD IN CASE PACKS OF DOZEN.

		CASE PACK
FL-003601	TEASPOON	1 DOZ.
FL-003602	ICED TEASPOON	1 DOZ.
FL-003603	DINNER SPOON	1 DOZ.
FL-003604	BOUILLON SPOON	1 DOZ.
FL-003605	DINNER FORK	1 DOZ.
FL-003606	SALAD FORK	1 DOZ.
FL-003607	OYSTER FORK	1 DOZ.
FL-003608	DINNER KNIFE	1 DOZ.
FL-003609	DEMITASSE SPOON	1 DOZ.
FL-003610	TABLE SPOON, EURO.	1 DOZ.
FL-003611	TABLE FORK, EURO.	1 DOZ.
FL-003612	BUTTER SPREADER	1 DOZ.
FL-003616	8 1/4" O.L. SALAD KNIFE	1 DOZ.



SHANGARILA (18/10 STAINLESS) EXTRA HEAVY WEIGHT. SOLD IN CASE PACKS OF DOZEN.

		CASE PACK
FL-003001	6" TEASPOON	1 DOZ.
FL-003002	7 3/8" ICED TEASPOON	1 DOZ.
FL-003003	7 1/4" DINNER SPOON	1 DOZ.
FL-003004	5 7/8" BOUILLON SPOON	1 DOZ.
FL-003005	7 1/4" DINNER FORK	1 DOZ.
FL-003006	6 1/4" SALAD FORK	1 DOZ.
FL-003007	5 1/2" OYSTER FORK	1 DOZ.
FL-003008	9" DINNER KNIFE	1 DOZ.
FL-003009	4 3/8" DEMITASSE SPOON	1 DOZ.
FL-003010	8 1/4" TABLE SPOON, EURO.	1 DOZ.
FL-003011	8 1/8" TABLE FORK, EURO.	1 DOZ.
FL-003012	6 3/4" BUTTER SPREADER	1 DOZ.
FL-003015	9 1/2" TABLE KNIFE, H.H.,	1 DOZ.
FL-003016	8.5" L. POINT TIP STEAK KNIFE	1 DOZ.
FL-003018	9 1/2" TABLE KNIFE, EURO.	1 DOZ.
FL-003019	8 1/4" O.L. SALAD KNIFE	1 DOZ.



PARISIAN (18/10 STAINLESS) SOLD IN CASE PACKS OF DOZEN.

		CASE PACK
FL-856901	TEASPOON	3 DOZ.
FL-856903	SERVING SPOON	1 DOZ.
FL-856904	ICED TEASPOON	2 DOZ.
FL-856905	DINNER FORK	2 DOZ.
FL-8569051	TABLE FORK	1 DOZ.
FL-856906	SALAD FORK	2 DOZ.
FL-856907	DESSERT SPOON	2 DOZ.
FL-856910	BUTTER KNIFE	1 DOZ.
FL-856912	BOUILLON SPOON	2 DOZ.
FL-856915	COCKTAIL FORK	2 DOZ.
FL-856929	DEMITASSE SPOON	2 DOZ.
FL-856945	1 PC DINNER KNIFE	1 DOZ.
FL-856999	5 PC. SETTING, US	1 EA.



BOSA NOVA (18/0 STAINLESS) SOLD IN CASE PACKS OF DOZEN.

		CASE PACK
FL-1801	TEASPOON	3 DOZ.
FL-1804	ICED TEA SPOON	3 DOZ.
FL-1805	DINNER FORK	3 DOZ.
FL-18051	EUROPEAN FORK	3 DOZ.
FL-1806	SALAD FORK	3 DOZ.
FL-1807	DESSERT SPOON	3 DOZ.
FL-1811	BUTTER KNIFE	3 DOZ.
FL-1812	BOUILLON SPOON	3 DOZ.
FL-1815	COCKTAIL FORK	3 DOZ.
FL-1829	DEMITASSE SPOON	3 DOZ.
FL-1890	5 PC. SETTING, EURO	1 EA.
FL-1899	5 PC. SETTING, US	1 EA.



IMAGINATION (18/0 STAINLESS) SOLD IN CASE PACKS OF DOZEN.

		CASE PACK
FL-8801	TEASPOON	3 DOZ.
FL-8804	ICED TEA SPOON	2 DOZ.
FL-8805	DINNER FORK	2 DOZ.
FL-8806	SALAD FORK	2 DOZ.
FL-8807	DESSERT SPOON	2 DOZ.
FL-8812	BOUILLON SPOON	2 DOZ.
FL-8815	COCKTAIL FORK	2 DOZ.
FL-8845	1-PIECE DINNER KNIFE	1 DOZ.
FL-8899	5 PC. SETTING, US	1 EA.



CLASSIC BAROQUE (18/10 STAINLESS) SOLD IN CASE PACKS OF DOZEN.

		CASE PACK
FL-6801	TEASPOON	1 DOZ.
FL-6803	SERVING SPOON	1 DOZ.
FL-6804	ICED TEA SPOON	1 DOZ.
FL-6805	DINNER FORK	1 DOZ.
FL-68051	EUROPEAN FORK	1 DOZ.
FL-6806	SALAD FORK	1 DOZ.
FL-6807	DESSERT SPOON	1 DOZ.
FL-6811	BUTTER KNIFE	1 DOZ.
FL-6812	BOUILLON SPOON	1 DOZ.
FL-6815	COCKTAIL FORK	1 DOZ.
FL-6829	DEMITASSE SPOON	1 DOZ.
FL-6845	KNIFE, 1 PIECE	1 DOZ.
FL-68451	EUROPEAN KNIFE	1 DOZ.
FL-6890	5 PC. SETTING, EURO	1 EA.
FL-6899	5 PC. SETTING, US	1 EA.



BALANCE (18/0 STAINLESS) SOLD IN CASE PACKS OF DOZEN.

		CASE PACK
FL-7901	TEASPOON	3 DOZ.
FL-7903	SERVING SPOON	1 DOZ.
FL-7904	ICED TEA SPOON	2 DOZ.
FL-7905	DINNER FORK	2 DOZ.
FL-7906	SALAD FORK	2 DOZ.
FL-7907	DESSERT SPOON	2 DOZ.
FL-7911	BUTTER KNIFE, S.H.	1 DOZ.
FL-7912	BOUILLON SPOON	2 DOZ.
FL-7915	COCKTAIL FORK	2 DOZ.
FL-7929	DEMITASSE SPOON	2 DOZ.
FL-7945	KNIFE, 1 PIECE	1 DOZ.
FL-79051	DINNER FORK, EURO	1 DOZ.
FL-79451	KNIFE, 1 PIECE, EURO	1 DOZ.
FL-7990	5 PC SETTING, EURO	1 EA.
FL-7999	5 PC SETTING, US	1 EA.



VENICE (18/10 STAINLESS) EXTRA HEAVY WEIGHT. SOLD IN CASE PACKS OF DOZEN.

		CASE PACK
FL-003701	TEASPOON	1 DOZ.
FL-003702	ICED TEASPOON	1 DOZ.
FL-003703	DINNER SPOON	1 DOZ.
FL-003704	BOUILLON SPOON	1 DOZ.
FL-003705	DINNER FORK	1 DOZ.
FL-003706	SALAD FORK	1 DOZ.
FL-003707	OYSTER FORK	1 DOZ.
FL-003708	DINNER KNIFE	1 DOZ.
FL-003709	DEMITASSE SPOON	1 DOZ.
FL-003710	TABLE SPOON	1 DOZ.
FL-003711	TABLE FORK	1 DOZ.
FL-003712	BUTTER SPREADER	1 DOZ.



**CAMELOT (18/0 STAINLESS)**  
SOLD IN CASE PACKS OF DOZEN.

		CASE PACK
FL-3901	TEASPOON	3 DOZ.
FL-3903	SERVING SPOON	2 DOZ.
FL-3904	ICED TEA SPOON	2 DOZ.
FL-3905	DINNER FORK	2 DOZ.
FL-39051	EUROPEAN FORK	2 DOZ.
FL-3906	SALAD FORK	2 DOZ.
FL-3907	DESSERT SPOON	2 DOZ.
FL-3912	BOUILLON SPOON	2 DOZ.
FL-3915	COCKTAIL FORK	2 DOZ.
FL-3929	DEMITASSE SPOON	2 DOZ.
FL-3945	1-PC DINNER KNIFE	1 DOZ.
FL-3999	5 PC. SETTING, US	1 EA.



**SHOWBOAT (18/0 STAINLESS)**  
SOLD IN CASE PACKS OF DOZEN.

		CASE PACK
FL-7301	TEASPOON	3 DOZ.
FL-7304	ICED TEA SPOON	2 DOZ.
FL-7305	DINNER FORK	2 DOZ.
FL-7306	SALAD FORK	2 DOZ.
FL-7307	DESSERT SPOON	2 DOZ.
FL-7310	BUTTER SPREADER	1 DOZ.
FL-7312	BOUILLON SPOON	2 DOZ.
FL-7315	COCKTAIL FORK	2 DOZ.
FL-7345	1-PIECE DINNER KNIFE	1 DOZ.
FL-7399	5 PC. SETTING, US	1 EA.



**ARBOR ROSE (18/8 STAINLESS)**  
SOLD IN CASE PACKS OF DOZEN.

		CASE PACK
FL-390101	TEASPOON	1 DOZ.
FL-390103	SERVING SPOON	1 DOZ.
FL-390104	ICED TEA SPOON	1 DOZ.
FL-390105	DINNER FORK	1 DOZ.
FL-390106	DESSERT FORK	1 DOZ.
FL-390107	DESSERT SPOON	1 DOZ.
FL-390112	BOUILLON SPOON	1 DOZ.
FL-390115	COCKTAIL FORK	1 DOZ.
FL-390145	DINNER KNIFE	1 DOZ.



**FREYA (18/0 STAINLESS)**  
SOLD IN CASE PACKS OF DOZEN.

		CASE PACK
FL-850601	TEASPOON	1 DOZ.
FL-850603	SERVING SPOON	1 DOZ.
FL-850604	ICED TEASPOON	1 DOZ.
FL-8506051	TABLE FORK	1 DOZ.
FL-850606	SALAD FORK	1 DOZ.
FL-850607	DESSERT SPOON	1 DOZ.
FL-850610	BUTTER SPREAD F.H.	1 DOZ.
FL-850615	COCKTAIL FORK	1 DOZ.
FL-850629	DEMITASSE SPOON	1 DOZ.
FL-850638	ROUND BOWL SOUP SPOON	1 DOZ.
FL-850642	STANDING DINNER KNIFE	1 DOZ.
FL-850690	5 PC. SETTING, EURO	1 EA.



**JOREEN (18/10 STAINLESS)**  
SOLD IN CASE PACKS OF DOZEN.

		CASE PACK
FL-300101	TEASPOON	1 DOZ.
FL-300404	ICED TEA SPOON	1 DOZ.
FL-300505	DINNER FORK	1 DOZ.
FL-300707	DESSERT SPOON	1 DOZ.
FL-301111	BUTTER KNIFE	1 DOZ.
FL-301212	BOUILLON SPOON	1 DOZ.
FL-301515	COCKTAIL FORK	1 DOZ.
FL-304545	DINNER KNIFE	1 DOZ.
FL-30051051	EUROPEAN FORK	1 DOZ.
FL-3090	5 PC. SETTING, EURO	1 EA.



**STARS & STRIPES (18/0 STAINLESS)**  
SOLD IN CASE PACKS OF DOZEN.

		CASE PACK
FL-3201	TEASPOON	3 DOZ.
FL-3205	DINNER FORK	2 DOZ.
FL-3206	SALAD FORK	2 DOZ.
FL-3207	DESSERT SPOON	2 DOZ.
FL-3212	BOUILLON SPOON	2 DOZ.
FL-3245	KNIFE, 1 PC	1 DOZ.
FL-3299	5 PC. SETTING, US	1 EA.



**WINDSWEEP (STAINLESS)**  
HEAVYWEIGHT. SOLD IN CASE PACKS OF DOZEN.

		CASE PACK
FL-4601	TEASPOON	3 DOZ.
FL-4604	ICED TEA SPOON	2 DOZ.
FL-4605	DINNER FORK	2 DOZ.
FL-4606	SALAD FORK	2 DOZ.
FL-4607	DESSERT SPOON	2 DOZ.
FL-4612	BOUILLON SPOON	2 DOZ.
FL-4615	COCKTAIL FORK	2 DOZ.
FL-4645	KNIFE, 1 PC.	1 DOZ.
FL-469	5 PC. SETTING, US	1 EA.



**STREAMLINE (18/0 STAINLESS)**  
SOLD IN CASE PACKS OF DOZEN.

		CASE PACK
FL-3301	TEASPOON	3 DOZ.
FL-3303	SERVING SPOON	3 DOZ.
FL-3304	ICED TEA SPOON	2 DOZ.
FL-3305	DINNER FORK	2 DOZ.
FL-3306	SALAD FORK	2 DOZ.
FL-3307	DESSERT SPOON	2 DOZ.
FL-3312	BOUILLON SPOON	2 DOZ.
FL-3315	COCKTAIL FORK	2 DOZ.
FL-3345	KNIFE, 1 PC	1 DOZ.
FL-3399	5 PC. SETTING, US	1 EA.



**ROYAL BRISTOL (18/0 STAINLESS)**  
SOLD IN CASE PACKS OF DOZEN.

		CASE PACK
FL-5101	TEASPOON	3 DOZ.
FL-5103	SERVING SPOON	2 DOZ.
FL-5104	ICED TEA SPOON	3 DOZ.
FL-5105	DINNER FORK (3 TINE)	3 DOZ.
FL-5106	SALAD FORK	3 DOZ.
FL-5107	DESSERT SPOON	3 DOZ.
FL-5110	BUTTER KNIFE	2 DOZ.
FL-5111	BUTTER SPREADER	2 DOZ.
FL-5112	BOUILLON SPOON	3 DOZ.
FL-5115	COCKTAIL FORK	3 DOZ.
FL-5123	STEAK KNIFE, H.H.	1 DOZ.
FL-5125	DINNER KNIFE, H.H.	1 DOZ.
FL-5127	DINNER KNIFE, H.H.	1 DOZ.
FL-5145	KNIFE, 1 PC.	3 DOZ.
FL-5154	DINNER FORK (4 TINE)	3 DOZ.
FL-5199	5 PC. SETTING, US	1 EA.



**FANFARE (18/0 STAINLESS)**

A BRIGHT MIRROR FINISH. EUROPEAN SIZES.  
SOLD IN CASE PACKS OF DOZEN.

		CASE PACK
FL-2801	TEASPOON	3 DOZ.
FL-2803	SERVING SPOON	3 DOZ.
FL-2804	ICED TEA SPOON	3 DOZ.
FL-2805	DINNER FORK	3 DOZ.
FL-2806	SALAD FORK	3 DOZ.
FL-2807	DESSERT SPOON	3 DOZ.
FL-2811	BUTTER SPREADER	3 DOZ.
FL-2812	BOUILLON SPOON	3 DOZ.
FL-2815	COCKTAIL FORK	3 DOZ.
FL-2829	DEMITASSE SPOON	3 DOZ.
FL-2845	KNIFE, 1 PC.	3 DOZ.
FL-28051	EUROPEAN FORK	2 DOZ.
FL-28451	EUROPEAN KNIFE, 1 PC.	1 DOZ.
FL-2899	5 PC. SETTING, US	1 EA.



SUSANNAH (18/10 STAINLESS)

SATIN FINISH. SOLD IN CASE PACKS OF DOZEN.

		CASE PACK
FL-855601	TEASPOON	1 DOZ.
FL-855604	ICED TEASPOON	1 DOZ.
FL-855605	DINNER FORK	1 DOZ.
FL-8556051	TABLE FORK	1 DOZ.
FL-855607	DESSERT SPOON	1 DOZ.
FL-855611	BUTTER KNIFE	1 DOZ.
FL-855612	BOUILLON SPOON	1 DOZ.
FL-855615	COCKTAIL FORK	1 DOZ.
FL-855642	STAND UP KNIFE	1 DOZ.
FL-8556451	TABLE KNIFE 1 PC.	1 DOZ.
FL-855690	5 PC. SETTING, EURO	1 EA.



GODDESS (18/10 STAINLESS)

SOLD IN CASE PACKS OF DOZEN.

		CASE PACK
FL-2101	TEASPOON	3 DOZ.
FL-2103	SERVING SPOON	2 DOZ.
FL-2104	ICED TEA SPOON	2 DOZ.
FL-2105	DINNER FORK	2 DOZ.
FL-2106	SALAD FORK	2 DOZ.
FL-2107	DESSERT SPOON	2 DOZ.
FL-2110	BUTTER SPREADER, F.H.	2 DOZ.
FL-2112	BOUILLON SPOON	2 DOZ.
FL-2115	COCKTAIL FORK	2 DOZ.
FL-2145	KNIFE, 1 PC.	1 DOZ.
FL-21051	EUROPEAN FORK	2 DOZ.
FL-21451	EUROPEAN KNIFE	1 DOZ.
FL-2190	5 PC. SETTING, EURO	1 EA.
FL-2199	5 PC. SETTING, US	1 EA.



CONTINUO (18/10 STAINLESS)

SOLD IN CASE PACKS OF DOZEN.

		CASE PACK
FL-1901	TEASPOON	1 DOZ.
FL-1903	SERVING SPOON	1 DOZ.
FL-1904	ICED TEA SPOON	1 DOZ.
FL-1905	DINNER FORK	1 DOZ.
FL-1906	SALAD FORK	1 DOZ.
FL-1907	DESSERT SPOON	1 DOZ.
FL-1911	BUTTER KNIFE, S.H.	1 DOZ.
FL-1912	BOUILLON SPOON	1 DOZ.
FL-1915	COCKTAIL FORK	1 DOZ.
FL-1929	DEMITASSE SPOON	1 DOZ.
FL-1945	KNIFE, 1 PC.	1 DOZ.
FL-19051	EUROPEAN FORK	1 DOZ.
FL-19451	EUROPEAN KNIFE	1 DOZ.
FL-1990	5 PC. SETTING, EURO	1 EA.
FL-1999	5 PC. SETTING, US	1 EA.



PEACOCK (18/8 STAINLESS)

SOLD IN CASE PACKS OF DOZEN.

		CASE PACK
FL-003101	TEASPOON	1 DOZ.
FL-003102	ICED TEA SPOON	1 DOZ.
FL-003103	DINNER SPOON	1 DOZ.
FL-003104	BOUILLON SPOON	1 DOZ.
FL-003105	DINNER FORK	1 DOZ.
FL-003106	SALAD FORK	1 DOZ.
FL-003107	OYSTER FORK	1 DOZ.
FL-003108	DINNER KNIFE	1 DOZ.
FL-003109	DEMITASSE SPOON	1 DOZ.
FL-003111	TABLE FORK(EURO.)	1 DOZ.
FL-003112	BUTTER SPREADER	1 DOZ.
FL-003118	TABLE KNIFE (EURO.)	1 DOZ.



LISBON (18/0 STAINLESS)

SOLD IN CASE PACKS OF DOZEN.

		CASE PACK
FL-3401	TEASPOON	3 DOZ.
FL-3403	SERVING SPOON	3 DOZ.
FL-3404	ICED TEA SPOON	3 DOZ.
FL-3406	SALAD FORK	3 DOZ.
FL-3407	DESSERT SPOON	3 DOZ.
FL-3412	BOUILLON SPOON	3 DOZ.
FL-3415	COCKTAIL FORK	3 DOZ.
FL-3429	DEMITASSE SPOON	3 DOZ.
FL-3445	DINNER KNIFE	3 DOZ.
FL-34051	TABLE FORK	3 DOZ.
FL-3490	5 PC. SETTING, EURO	1 EA.



RUSTIC TREE (18/10 STAINLESS)

SATIN FINISH. SOLD IN CASE PACKS OF DOZEN.

		CASE PACK
FL-1301	TEASPOON	1 DOZ.
FL-1303	SERVING SPOON	1 DOZ.
FL-1305	DINNER FORK	1 DOZ.
FL-1306	SALAD FORK	1 DOZ.
FL-1307	DESSERT SPOON	1 DOZ.
FL-1311	BUTTER KNIFE, S.H.	1 DOZ.
FL-1312	BOUILLON SPOON	1 DOZ.
FL-1315	COCKTAIL FORK	1 DOZ.
FL-1329	DEMITASSE SPOON	1 DOZ.
FL-1345	KNIFE, 1 PC.	3 DOZ.
FL-1399	5 PC. SETTING, US	1 EA.



SAVILLE (18/0 STAINLESS)

EXTRA HEAVYWEIGHT. CLASSIC MIRROR FINISH. SOLD IN CASE PACKS OF DOZEN.

		CASE PACK
FL-66601	TEASPOON	3 DOZ.
FL-66602	EUROPEAN DESSERT SPOON	2 DOZ.
FL-66603	SERVING SPOON	2 DOZ.
FL-66604	ICED TEA SPOON	2 DOZ.
FL-66605	DINNER FORK	2 DOZ.
FL-66606	SALAD FORK	2 DOZ.
FL-66607	DESSERT SPOON	2 DOZ.
FL-66611	BUTTER SPREADER, F.H.	2 DOZ.
FL-66612	BOUILLON SPOON	2 DOZ.
FL-66615	COCKTAIL FORK	2 DOZ.
FL-66629	DEMITASSE SPOON	2 DOZ.
FL-66645	KNIFE, 1 PC.	1 DOZ.
FL-666051	EUROPEAN DINNER FORK	2 DOZ.
FL-666451	EUROPEAN KNIFE	1 DOZ.
FL-66690	5 PC. SETTING, EURO	1 EA.
FL-66699	5 PC. SETTING, US	1 EA.



SONNET (18/0 STAINLESS)

SOLD IN CASE PACKS OF DOZEN.

		CASE PACK
FL-858201	TEASPOON	3 DOZ.
FL-858203	SERVING SPOON	2 DOZ.
FL-858204	ICED TEASPOON	2 DOZ.
FL-858205	DINNER FORK	2 DOZ.
FL-858206	SALAD FORK	2 DOZ.
FL-858207	DESSERT SPOON	2 DOZ.
FL-858211	BUTTER SPREADER, F.H.	2 DOZ.
FL-858212	BOUILLON SPOON	2 DOZ.
FL-858215	COCKTAIL FORK	2 DOZ.
FL-858223	STEAK KNIFE, H.H.	1 DOZ.
FL-858225	KNIFE, H.H.	1 DOZ.
FL-858229	DEMITASSE SPOON	2 DOZ.
FL-858245	1 PC DINNER KNIFE	1 DOZ.
FL-858299	5 PC. SETTING, US	1 EA.



IDOL (STAINLESS STEEL)

SOLD IN CASE PACKS OF DOZEN.

		CASE PACK
FL-0101	TEASPOON	1 DOZ.
FL-0103	SERVING SPOON	1 DOZ.
FL-0104	ICED TEASPOON	1 DOZ.
FL-0105	DINNER FORK	1 DOZ.
FL-01051	EURO. DINNER FORK	1 DOZ.
FL-0106	SALAD FORK	1 DOZ.
FL-0107	DESSERT SPOON	1 DOZ.
FL-0110	BUTTER SPREADER	1 DOZ.
FL-0112	BOUILLON SPOON	1 DOZ.
FL-0115	COCKTAIL FORK	1 DOZ.
FL-0129	DEMITASSE SPOON	1 DOZ.
FL-0145	DINNER KNIFE	1 DOZ.
FL-01451	EURO. DINNER KNIFE	1 DOZ.
FL-0190	5 PC PLACE SETTING, EURO	1 EA.
FL-0199	5 PC PLACE SETTING, US	1 EA.



CLASSIC SILVER (SILVERPLATE)

SOLD IN CASE PACKS OF DOZEN.

		CASE PACK
FL-4201	TEASPOON	3 DOZ.
FL-4204	ICED TEA SPOON	3 DOZ.
FL-4205	DINNER FORK	3 DOZ.
FL-4206	SALAD FORK	3 DOZ.
FL-4207	DESSERT SPOON	3 DOZ.
FL-4210	BUTTER SPREADER	3 DOZ.
FL-4212	BOUILLON SPOON	3 DOZ.
FL-4215	COCKTAIL FORK	3 DOZ.
FL-4229	DEMITASSE SPOON	3 DOZ.
FL-42051	TABLE FORK	3 DOZ.
FL-42451	1 PC. HEAVYWEIGHT KNIFE	3 DOZ.
FL-4299	5 PC. SETTING, US	1 EA.



**BARCLAY (STAINLESS)**

BRIGHT FINISH. SOLD IN CASE PACKS OF DOZEN.

		CASE PACK
FL-1101	TEASPOON	3 DOZ.
FL-1103	SERVING SPOON	3 DOZ.
FL-1104	ICED TEA SPOON	3 DOZ.
FL-1105	DINNER FORK	3 DOZ.
FL-1106	SALAD FORK	3 DOZ.
FL-1107	DESSERT SPOON	3 DOZ.
FL-1112	BOUILLON SPOON	3 DOZ.
FL-1115	COCKTAIL FORK	3 DOZ.
FL-1129	DEMITASSE SPOON	3 DOZ.
FL-1145	KNIFE, 1 PC.	3 DOZ.
FL-1199	5 PC PLACE SETTING, US	1 EA.
FL-11901	5 1/8" CHILDREN TEASPOON	1 DOZ.
FL-11905	5" CHILDREN DINNER FORK	1 DOZ.
FL-11945	6" CHILDREN DINNER KNIFE	1 DOZ.



**COLGATE (18/0 STAINLESS)**

SOLD IN CASE PACKS OF DOZEN.

		CASE PACK
FL-2701	TEASPOON, 6 1/2"	3 DOZ.
FL-2703	SERVING SPOON, 8 9/16"	3 DOZ.
FL-2704	ICED TEA SPOON, 7 6/16"	3 DOZ.
FL-2705	DINNER FORK, 7 1/2"	3 DOZ.
FL-27051	TABLE FORK, 8 1/8"	3 DOZ.
FL-2706	SALAD FORK, 6 1/2"	3 DOZ.
FL-2707	DESSERT SPOON, 7 1/2"	3 DOZ.
FL-2711	BUTTER SPREADER, 7 1/8"	3 DOZ.
FL-2712	BOUILLON SPOON, 6 1/4"	3 DOZ.
FL-2715	COCKTAIL FORK, 5 7/8"	3 DOZ.
FL-2745	1-PIECE KNIFE, 8 5/8"	3 DOZ.
FL-2799	5 PC PLACE SETTING, US	1 EA.



**OLDE TOWNE (18/0 STAINLESS)**

SOLD IN CASE PACKS OF DOZEN.

		CASE PACK
FL-8401	TEASPOON	3 DOZ.
FL-8404	ICED TEA SPOON	2 DOZ.
FL-8405	DINNER FORK	2 DOZ.
FL-8406	SALAD FORK	2 DOZ.
FL-8407	DESSERT SPOON	2 DOZ.
FL-8412	BOUILLON SPOON	2 DOZ.
FL-8415	COCKTAIL FORK	2 DOZ.
FL-8445	KNIFE, 1 PC	1 DOZ.
FL-8499	5 PC PLACE SETTING, US	1 EA.



**ACCOLADE (STAINLESS)**

HEAVYWEIGHT. SOLD IN CASE PACKS OF DOZEN.

		CASE PACK
FL-4501	TEASPOON	3 DOZ.
FL-4503	SERVING SPOON	3 DOZ.
FL-4504	ICED TEA SPOON	3 DOZ.
FL-4505	DINNER FORK	3 DOZ.
FL-4506	SALAD FORK	3 DOZ.
FL-4507	DESSERT SPOON	3 DOZ.
FL-4512	BOUILLON SPOON	3 DOZ.
FL-4515	COCKTAIL FORK	2 DOZ.
FL-4529	DEMITASSE SPOON	2 DOZ.
FL-4545	KNIFE, 1 PC.	3 DOZ.
FL-4599	5 PC PLACE SETTING, US	1 EA.



**WINDSOR (STAINLESS)**

MEDIUM WEIGHT. SOLD IN CASE PACKS OF DOZEN.

		CASE PACK
FL-7201	TEASPOON	3 DOZ.
FL-7203	SERVING SPOON	3 DOZ.
FL-7204	ICED TEA SPOON	3 DOZ.
FL-7205	DINNER FORK	3 DOZ.
FL-7206	SALAD FORK	3 DOZ.
FL-7207	DESSERT SPOON	3 DOZ.
FL-7212	BOUILLON SPOON	3 DOZ.
FL-7215	COCKTAIL FORK	3 DOZ.
FL-7224	KNIFE, 42 GR. SERRATED, 1 PC.	3 DOZ.
FL-7229	DEMITASSE SPOON	3 DOZ.
FL-7299	5 PC PLACE SETTING, US	1 EA.

**WINDSOR (STAINLESS)**

HEAVYWEIGHT. SOLD IN CASE PACKS OF DOZEN.

		CASE PACK
FL-8901	TEASPOON	2 DOZ.
FL-8903	SERVING SPOON	2 DOZ.
FL-8904	ICED TEA SPOON	2 DOZ.
FL-8905	DINNER FORK	2 DOZ.
FL-8906	SALAD FORK	2 DOZ.
FL-8907	DESSERT SPOON	2 DOZ.
FL-8912	BOUILLON SPOON	2 DOZ.
FL-8915	COCKTAIL FORK	2 DOZ.
FL-8945	KNIFE, 55 GR. SERR., 1 PC.	2 DOZ.
FL-8999	5 PC PLACE SETTING, US	1 EA.



**DOMINION (STAINLESS)**

MEDIUM WEIGHT. SOLD IN CASE PACKS OF DOZEN.

		CASE PACK
FL-7401	TEASPOON	3 DOZ.
FL-7403	SERVING SPOON	2 DOZ.
FL-7404	ICED TEA SPOON	2 DOZ.
FL-7405	DINNER FORK	2 DOZ.
FL-7406	SALAD FORK	2 DOZ.
FL-7407	DESSERT SPOON	2 DOZ.
FL-7412	BOUILLON SPOON	2 DOZ.
FL-7415	COCKTAIL FORK	2 DOZ.
FL-7429	DEMITASSE SPOON	3 DOZ.
FL-7443	KNIFE, 42 GR. SERRATED, 1 PC.	1 DOZ.
FL-7299	5 PC PLACE SETTING, US	1 EA.

**DOMINION (STAINLESS)**

HEAVYWEIGHT. SOLD IN CASE PACKS OF DOZEN.

		CASE PACK
FL-8701	TEASPOON	3 DOZ.
FL-8703	SERVING SPOON	2 DOZ.
FL-8704	ICED TEA SPOON	2 DOZ.
FL-8705	DINNER FORK	2 DOZ.
FL-8706	SALAD FORK	2 DOZ.
FL-8707	DESSERT SPOON	2 DOZ.
FL-8712	BOUILLON SPOON	2 DOZ.
FL-8715	COCKTAIL FORK	2 DOZ.
FL-8745	KNIFE, 55 GR. SERR., 1 PC.	1 DOZ.
FL-8799	5 PC PLACE SETTING, US	1 EA.

**AUDITION (18/10 STAINLESS)**

SOLD IN CASE PACKS OF DOZEN.

		CASE PACK
FL-15401	TEASPOON	1 DOZ.
FL-15404	ICED TEASPOON	1 DOZ.
FL-15405	DINNER FORK	1 DOZ.
FL-15406	SALAD FORK	1 DOZ.
FL-15407	DESSERT SPOON	1 DOZ.
FL-15411	BUTTER KNIFE	1 DOZ.
FL-15412	BOUILLON SPOON	1 DOZ.
FL-15422	STEAK KNIFE	1 DOZ.
FL-15429	DEMI SPOON	1 DOZ.
FL-15445	DINNER KNIFE	1 DOZ.
FL-15490	EUROPEAN 5 PIECE SET	1 EA.



**ILLUSTRA (18/10 STAINLESS)**

MEDIUM WEIGHT. SOLD IN CASE PACKS OF DOZEN.

		CASE PACK
FL-9101	TEASPOON	3 DOZ.
FL-9103	SERVING SPOON	2 DOZ.
FL-9104	ICED TEA SPOON	2 DOZ.
FL-9105	DINNER FORK	2 DOZ.
FL-9106	SALAD FORK	2 DOZ.
FL-9107	DESSERT SPOON	2 DOZ.
FL-9110	BUTTER SPREADER	2 DOZ.
FL-9111	BUTTER KNIFE, S.H.	1 DOZ.
FL-9112	BOUILLON SPOON	2 DOZ.
FL-9115	COCKTAIL FORK	2 DOZ.
FL-9125	KNIFE, H.H.	1 DOZ.
FL-9129	DEMI SPOON	2 DOZ.
FL-9145	KNIFE, 1 PC.	1 DOZ.
FL-91051	EUROPEAN FORK	2 DOZ.
FL-91451	EURO. KNIFE, 1 PC.	1 DOZ.
FL-9190	5 PC. SETTING, EURO	1 EA.
FL-9199	5 PC. SETTING, US	1 EA.



**ART DECO (18/10 STAINLESS STEEL)**

SOLD IN CASE PACKS OF DOZEN.

		CASE PACK
FL-8001	TEASPOON	3 DOZ.
FL-8003	SERVING SPOON	2 DOZ.
FL-8004	ICED TEA SPOON	2 DOZ.
FL-8005	DINNER FORK	2 DOZ.
FL-8006	SALAD FORK	2 DOZ.
FL-8007	DESSERT SPOON	2 DOZ.
FL-8011	BUTTER KNIFE, S.H.	2 DOZ.
FL-8012	BOUILLON SPOON	2 DOZ.
FL-8015	COCKTAIL FORK	2 DOZ.
FL-8029	DEMITASSE SPOON	2 DOZ.
FL-8045	1 PC. DINNER KNIFE	1 DOZ.
FL-80051	EUROPEAN FORK	2 DOZ.
FL-80451	EUROPEAN KNIFE	1 DOZ.
FL-8090	5 PC. SETTING, EURO	1 EA.
FL-8099	5 PC. SETTING, US	1 EA.



**AUDITION (18/10 STAINLESS)**

SOLD IN CASE PACKS OF DOZEN.

		CASE PACK
FL-15401	TEASPOON	1 DOZ.
FL-15404	ICED TEASPOON	1 DOZ.
FL-15405	DINNER FORK	1 DOZ.
FL-15406	SALAD FORK	1 DOZ.
FL-15407	DESSERT SPOON	1 DOZ.
FL-15411	BUTTER KNIFE	1 DOZ.
FL-15412	BOUILLON SPOON	1 DOZ.
FL-15422	STEAK KNIFE	1 DOZ.
FL-15429	DEMI SPOON	1 DOZ.
FL-15445	DINNER KNIFE	1 DOZ.
FL-15490	EUROPEAN 5 PIECE SET	1 EA.



**BECKET (SILVERPLATE)**

SOLD IN CASE PACKS OF DOZEN.

		CASE PACK
FL-132501	TEASPOON	3 DOZ.
FL-132503	SERVING SPOON	3 DOZ.
FL-132504	ICED TEA SPOON	3 DOZ.
FL-132505	AMERICAN DINNER FORK	3 DOZ.
FL-132506	SALAD/DESSERT FORK	3 DOZ.
FL-132511	BUTTER SPREADER, 1 PC.	3 DOZ.
FL-132512	BOUILLON SPOON	3 DOZ.
FL-132515	OYSTER/COCKTAIL FORK	3 DOZ.
FL-132529	DEMITASSE SPOON	3 DOZ.
FL-132545	DINNER KNIFE, HEAVY 1 PC.	3 DOZ.
FL-1325051	EUROPEAN FORK	3 DOZ.





**NOUVEAUX HAMMERED (18/10 STAINLESS)**  
SOLD IN CASE PACKS OF DOZEN.

		CASE PACK
FL-855801	TEASPOON	1 DOZ.
FL-855803	SERVING SPOON	1 DOZ.
FL-855805	DINNER FORK	1 DOZ.
FL-855806	SALAD FORK	1 DOZ.
FL-855807	DESSERT SPOON	1 DOZ.
FL-855811	BUTTER KNIFE S.H.	1 DOZ.
FL-855812	BOUILLON SPOON	1 DOZ.
FL-855829	DEMITASSE SPOON	1 DOZ.
FL-855845	DINNER KNIFE	1 DOZ.
FL-855899	5 PC. SETTING, US	1 EA.



**SOHO (18/10 STAINLESS)**  
SOLD IN CASE PACKS OF DOZEN.

		CASE PACK
FL-850701	TEASPOON	1 DOZ.
FL-850703	SERVING SPOON	1 DOZ.
FL-850704	ICED TEASPOON	1 DOZ.
FL-850705	DINNER FORK	1 DOZ.
FL-8507051	EURO TABLE FORK	1 DOZ.
FL-850707	DESSERT SPOON	1 DOZ.
FL-850712	BOUILLON SPOON	1 DOZ.
FL-850715	COCKTAIL FORK	1 DOZ.
FL-850745	DINNER KNIFE	1 DOZ.
FL-8507451	EURO TABLE KNIFE	1 DOZ.
FL-85090	5 PC. SETTING, EURO	1 EA.



**CLASSIC BAROQUE (18/10 STAINLESS)**  
SOLD IN CASE PACKS OF DOZEN.

	CASE PACK	STAINLESS
TEASPOON	1 DOZ.	FL-6801
SERVING SPOON	1 DOZ.	FL-6803
ICED TEA SPOON	1 DOZ.	FL-6804
DINNER FORK	1 DOZ.	FL-6805
EUROPEAN FORK	1 DOZ.	FL-68051
SALAD FORK	1 DOZ.	FL-6806
DESSERT SPOON	1 DOZ.	FL-6807
BUTTER KNIFE	1 DOZ.	FL-6811
BOUILLON SPOON	1 DOZ.	FL-6812
COCKTAIL FORK	1 DOZ.	FL-6815
DEMITASSE SPOON	1 DOZ.	FL-6829
KNIFE, 1 PIECE	1 DOZ.	FL-6845
EUROPEAN KNIFE	1 DOZ.	FL-68451
5 PC. SETTING, EURO	1 EA.	FL-6890
5 PC. SETTING, US	1 EA.	FL-6899



	SILVERPLATE	GOLDPLATE	PEWALUM
FL-6801SP	FL-6801SP	FL-6801GP	FL-6801PW
FL-6803SP	FL-6803SP	FL-6803GP	FL-6803PW
FL-6804SP	FL-6804SP	FL-6804GP	FL-6804PW
FL-6805SP	FL-6805SP	FL-6805GP	FL-6805PW
FL-68051SP	FL-68051SP	FL-68051GP	FL-68051PW
FL-6806SP	FL-6806SP	FL-6806GP	FL-6806PW
FL-6807SP	FL-6807SP	FL-6807GP	FL-6807PW
FL-6811SP	FL-6811SP	FL-6811GP	FL-6811PW
FL-6812SP	FL-6812SP	FL-6812GP	FL-6812PW
FL-6815SP	FL-6815SP	FL-6815GP	FL-6815PW
FL-6829SP	FL-6829SP	FL-6829GP	FL-6829PW
FL-6845SP	FL-6845SP	FL-6845GP	FL-6845PW
FL-68451SP	FL-68451SP	FL-68451GP	FL-68451PW
FL-6890SP	FL-6890SP	FL-6890GP	FL-6890PW
FL-6899SP	FL-6899SP	FL-6899GP	FL-6899PW



**NEW!**

**TRUSS™ (18/10 STAINLESS STEEL)**

FORMED WITH 18/10 STAINLESS STEEL CONSTRUCTION THIS COLLECTION OFFERS STRENGTH, DURABILITY, AND RELIABILITY FOR ANY COMMERCIAL FOODSERVICE ESTABLISHMENT. THE PATTERN FEATURES MASSIVE SIZE, HEAVYWEIGHT STRENGTH, AND SLEEK LINEAR DESIGN LIKE AN ANCIENT ROMAN STRUCTURE. THE TRUSS LINE PIECES COMBINE LARGE SIZE ELEMENTS WITH SLEEK ANGLED LINEAR DESIGNS TO CREATE A DISTINCT AESTHETIC. THIS PATTERN HAS A SHINY MIRROR POLISH FINISH, WHICH IS A PERFECT ACCENT FOR CULINARY PRESENTATIONS. COMMERCIAL DISHWASHER SAFE.

		CASE PACK
FL-10501	4 1/2" TEASPOON	1 DOZ.
FL-10503	8 1/2" SERVING SPOON	1 DOZ.
FL-10504	7 3/4" ICED TEASPOON	1 DOZ.
FL-10505	7 3/4" DINNER FORK	1 DOZ.
FL-105051	8 1/3" EURO DINNER FORK	1 DOZ.
FL-10506	7 1/8" SALAD/DESSERT FORK	1 DOZ.
FL-10507	7 1/2" DESSERT SPOON	1 DOZ.
FL-10511	7 1/4" BUTTER KNIFE	1 DOZ.
FL-10512	6 3/4" BOUILLON SPOON	1 DOZ.
FL-10515	5 1/2" COCKTAIL FORK	1 DOZ.
FL-10529	4 1/2" DEMITASSE SPOON	1 DOZ.
FL-10545	9 1/4" DINNER KNIFE	1 DOZ.
FL-105451	9 3/4" EURO DINNER KNIFE	1 DOZ.



**IMPERIAL CAVIAR GOLD (GOLDPLATED)**

THIS GOLDPLATED PATTERN IS A HAMMERED DESIGN. SOLD IN CASE PACKS OF DOZEN.

		CASE PACK
FL-85701	TEASPOON	1 DOZ.
FL-85705	DINNER FORK	1 DOZ.
FL-85706	SALAD FORK	1 DOZ.
FL-85707	DESSERT SPOON	1 DOZ.
FL-85745	DINNER KNIFE	1 DOZ.



**QUICK SHIP**

**GOLDEN ELEGANCE**  
SOLD IN CASE PACKS OF DOZEN.

		CASE PACK
FL-250001	TEASPOON	1 DOZ.
FL-250005	DINNER FORK	1 DOZ.
FL-250006	SALAD FORK	1 DOZ.
FL-250007	DESSERT SPOON	1 DOZ.
FL-250011	BUTTER KNIFE	1 DOZ.
FL-250012	BOUILLON/SOUP SPOON	1 DOZ.
FL-250015	COCKTAIL FORK	1 DOZ.
FL-250029	DEMITASSE SPOON	1 DOZ.
FL-250045	LUNCH/DINNER KNIFE	1 DOZ.
FL-2500451	DINNER/EUROPEAN KNIFE	1 DOZ.



**QUICK SHIP**

**GOLDEN FAN**  
SOLD IN CASE PACKS OF DOZEN.

		CASE PACK
FL-260001	TEASPOON	1 DOZ.
FL-260005	DINNER FORK	1 DOZ.
FL-260006	SALAD FORK	1 DOZ.
FL-260007	DESSERT SPOON	1 DOZ.
FL-260011	BUTTER KNIFE	1 DOZ.
FL-260012	BOUILLON/SOUP SPOON	1 DOZ.
FL-2600451	DINNER/EUROPEAN KNIFE	1 DOZ.



**QUICK SHIP**

**GOLDEN CURVE (GOLDPLATE)**  
A HAMMERED FINISH WITH GOLDPLATING DEFINES RICHNESS AND BEAUTY. SOLD IN CASE PACKS OF DOZEN.

		CASE PACK
FL-440001	TEASPOON	1 DOZ.
FL-440005	DINNER FORK	1 DOZ.
FL-440006	SALAD FORK	1 DOZ.
FL-440007	DESSERT SPOON	1 DOZ.
FL-440011	BUTTER KNIFE	1 DOZ.
FL-440029	DEMI SPOON	1 DOZ.
FL-440045	DINNER KNIFE	1 DOZ.



**QUICK SHIP**

**GOLDEN GLARE (GOLDPLATE)**  
THIS HEAVY DUTY 18/10 STAINLESS PATTERN IS PLATED IN 24 CARAT GOLD. SOLD IN CASE PACKS OF DOZEN.

		CASE PACK
FL-430001	TEASPOON	1 DOZ.
FL-430005	DINNER FORK	1 DOZ.
FL-430006	SALAD FORK	1 DOZ.
FL-430007	DESSERT SPOON	1 DOZ.
FL-430011	BUTTER KNIFE	1 DOZ.
FL-430029	DEMI SPOON	1 DOZ.
FL-430045	DINNER KNIFE	1 DOZ.



**MAX MOD (18/10 STAINLESS)**

SOLD IN CASE PACKS OF DOZEN.

		CASE PACK
FL-150001	TEASPOON	1 DOZ.
FL-150004	ICED TEA SPOON	1 DOZ.
FL-150005	DINNER FORK	1 DOZ.
FL-150006	SALAD FORK	1 DOZ.
FL-150007	DESSERT SPOON	1 DOZ.
FL-150011	BUTTER KNIFE	1 DOZ.
FL-150012	BOUILLON/SOUP SPOON	1 DOZ.
FL-150015	COCKTAIL FORK	1 DOZ.
FL-150029	DEMITASSE SPOON	1 DOZ.



**ROSE GOLD MAX MOD (STAINLESS STEEL)**

ROSE GOLD MAX MOD IS MADE OF DURABLE STAINLESS STEEL WITH A STRAIGHT FORWARD, CONTEMPORARY DESIGN, AND THEN PLATED IN ROSE GOLD.

SOLD IN CASE PACKS OF DOZEN.

		CASE PACK
FL-130001	TEASPOON	1 DOZ.
FL-130005	DINNER FORK	1 DOZ.
FL-130006	SALAD FORK	1 DOZ.
FL-130007	DESSERT SPOON	1 DOZ.
FL-130045	DINNER KNIFE	1 DOZ.



**SHINY BLACK MAX MOD (STAINLESS STEEL)**

BLACK SHINY MAX MOD IS MADE OF DURABLE 18/10 STAINLESS STEEL WITH A STRAIGHT FORWARD, CONTEMPORARY DESIGN, AND FORGED IN A BLACK MATTE FINISH. SOLD IN CASE PACKS OF DOZEN.

		CASE PACK
FL-140001	TEASPOON	1 DOZ.
FL-140005	DINNER FORK	1 DOZ.
FL-140006	SALAD FORK	1 DOZ.
FL-140007	DESSERT SPOON	1 DOZ.
FL-140045	DINNER KNIFE	1 DOZ.



**COPPER RHODIE**

A TRADITIONAL ENGLISH STYLE SHAPE, RHODIE IS 18/10 STAINLESS STEEL WITH A HAMMERED COPPER FINISH. IT IS BRIGHT AND LUSTERED THAT IS PERFECT FOR ANY TRADITIONAL TABLE SETTING OR EVENT.

		CASE PACK
FL-460001	TEASPOON	1 DOZ.
FL-460005	DINNER FORK	1 DOZ.
FL-460006	SALAD FORK	1 DOZ.
FL-460007	DESSERT SPOON	1 DOZ.
FL-460045	DINNER KNIFE	1 DOZ.



**VENETIAN WHITE**

THE VENETIAN WHITE IS A MODERN FLATWARE PATTERN THAT IS TWO TONED. THE TOP IS 24K BRUSHED GOLD WITH THE BOTTOM HAVING A WHITE RESIN HANDLE. EACH PIECE IS SOLD BY THE DOZEN AND MUST BE HAND WASHED AND COMPLETELY DRIED AFTER USE.

		CASE PACK
FL-54801	TEASPOON	1 DOZ.
FL-54805	DINNER FORK	1 DOZ.
FL-54806	SALAD FORK	1 DOZ.
FL-54807	DESSERT SPOON	1 DOZ.
FL-54845	DINNER KNIFE	1 DOZ.



**VENETIAN BLACK**

THE VENETIAN BLACK IS A MODERN FLATWARE PATTERN THAT IS TWO TONED. THE TOP IS 24K BRUSHED GOLD WITH THE BOTTOM HAVING A BLACK RESIN HANDLE. EACH PIECE IS SOLD BY THE DOZEN AND MUST BE HAND WASHED AND COMPLETELY DRIED AFTER USE.

		CASE PACK
FL-54701	TEASPOON	1 DOZ.
FL-54705	DINNER FORK	1 DOZ.
FL-54706	SALAD FORK	1 DOZ.
FL-54707	DESSERT SPOON	1 DOZ.
FL-54745	DINNER KNIFE	1 DOZ.



**COPPER SLEEK SIMPLICITY**

SLEEK AND SIMPLE BUT ALSO A COPPER BRUSHED FINISH. THE HANDLES ARE NARROW IN SHAPE BUT THICK AND ROUNDED, GIVING YOU AN ELEGANT AND SIMPLE CONTEMPORARY STYLE THAT WILL WORK WELL WITH ANY CHINA SETTING. AN EXCELLENT OPTION FOR RENTAL APPLICATIONS, CATERERS AND RESTAURANTS!

		CASE PACK
FL-181001	TEASPOON	1 DOZ.
FL-181005	DINNER FORK	1 DOZ.
FL-181006	SALAD FORK	1 DOZ.
FL-181007	DESSERT SPOON	1 DOZ.
FL-181011	BUTTER KNIFE	1 DOZ.
FL-181029	DEMI SPOON	1 DOZ.
FL-181045	DINNER KNIFE	1 DOZ.
FL-1810451	EURO. DINNER KNIFE	1 DOZ.



**PEARL PLATINUM (18/10 STAINLESS)**

		CASE PACK
FL-61901	TEASPOON	1 DOZ.
FL-61905	DINNER FORK	1 DOZ.
FL-61906	SALAD/DESSERT FORK	1 DOZ.
FL-61907	DESSERT SPOON	1 DOZ.
FL-61945	DINNER KNIFE	1 DOZ.



**COLEBROOK (18/10 STAINLESS STEEL)**

THIS STALEY BLACK SHEEN OFFERS SIMPLE ELEGANCE THAT IS CONTEMPORARY AND CLASSIC. FEATURES 18/10 STAINLESS STEEL WITH BLACK ADHESIVE COATING THAT WILL NOT FADE.

		CASE PACK
FL-869901	TEASPOON	1 DOZ.
FL-869905	DINNER FORK	1 DOZ.
FL-869906	SALAD FORK	1 DOZ.
FL-869907	DESSERT SPOON	1 DOZ.
FL-869945	DINNER KNIFE	1 DOZ.



**ELEGANCE (SILVERPLATE)**  
SOLD IN CASE PACKS OF DOZEN.

		CASE PACK
FL-330001	TEASPOON	2 DOZ.
FL-330005	DINNER FORK	1 DOZ.
FL-330006	SALAD FORK	2 DOZ.
FL-330007	DESSERT SPOON	1 DOZ.
FL-330011	BUTTER KNIFE	2 DOZ.
FL-330012	BOUILLON/SOUP SPOON	2 DOZ.
FL-330015	COCKTAIL FORK	2 DOZ.
FL-330029	DEMITASSE SPOON	1 DOZ.
FL-330045	LUNCH/DINNER KNIFE	2 DOZ.
FL-3300451	DINNER/EUROPEAN KNIFE	1 DOZ.



**STRAND (SILVERPLATE)**  
SOLD IN CASE PACKS OF DOZEN.

		CASE PACK
FL-320001	TEASPOON	2 DOZ.
FL-320004	ICE TEASPOON	2 DOZ.
FL-320005	DINNER FORK	1 DOZ.
FL-320006	SALAD FORK	2 DOZ.
FL-320007	DESSERT SPOON	1 DOZ.
FL-320011	BUTTER KNIFE	2 DOZ.
FL-320015	COCKTAIL FORK	2 DOZ.
FL-320029	DEMITASSE SPOON	1 DOZ.
FL-320045	LUNCH/DINNER KNIFE	2 DOZ.
FL-3200451	DINNER/EUROPEAN KNIFE	1 DOZ.



**CURVE (SILVERPLATE)**  
SOLD IN CASE PACKS OF DOZEN.

		CASE PACK
FL-290001	TEASPOON	2 DOZ.
FL-290005	DINNER FORK	1 DOZ.
FL-290006	SALAD FORK	2 DOZ.
FL-290007	DESSERT SPOON	1 DOZ.
FL-290011	BUTTER KNIFE	2 DOZ.
FL-290015	COCKTAIL FORK	2 DOZ.
FL-290029	DEMITASSE SPOON	2 DOZ.
FL-290045	LUNCH/DINNER KNIFE	1 DOZ.
FL-2900451	DINNER/EUROPEAN KNIFE	1 DOZ.



**MAX (SILVERPLATE)**  
SOLD IN CASE PACKS OF DOZEN.

		CASE PACK
FL-300001	TEASPOON	2 DOZ.
FL-300004	ICE TEASPOON	2 DOZ.
FL-300005	DINNER FORK	1 DOZ.
FL-300006	SALAD FORK	2 DOZ.
FL-300007	DESSERT SPOON	1 DOZ.
FL-300011	BUTTER KNIFE	2 DOZ.
FL-300012	BOUILLON/SOUP SPOON	2 DOZ.
FL-300015	COCKTAIL FORK	2 DOZ.
FL-300029	DEMITASSE SPOON	1 DOZ.
FL-300045	LUNCH/DINNER KNIFE	2 DOZ.
FL-3000451	DINNER/EUROPEAN KNIFE	1 DOZ.



**GRAND (SILVERPLATE)**  
SOLD IN CASE PACKS OF DOZEN.

		CASE PACK
FL-310001	TEASPOON	2 DOZ.
FL-310003	SERVING SPOON	1 DOZ.
FL-310004	ICE TEASPOON	2 DOZ.
FL-310005	DINNER FORK	1 DOZ.
FL-310006	SALAD FORK	2 DOZ.
FL-310007	DESSERT SPOON	1 DOZ.
FL-310011	BUTTER KNIFE	2 DOZ.
FL-310015	COCKTAIL FORK	2 DOZ.
FL-310029	DEMITASSE SPOON	1 DOZ.
FL-310045	LUNCH/DINNER KNIFE	2 DOZ.
FL-3100451	DINNER/EUROPEAN KNIFE	1 DOZ.



**PEARLS (SILVERPLATE)**  
SOLD IN CASE PACKS OF DOZEN.

		CASE PACK
FL-280001	TEASPOON	2 DOZ.
FL-280005	DINNER FORK	1 DOZ.
FL-280006	SALAD FORK	2 DOZ.
FL-280007	DESSERT SPOON	1 DOZ.
FL-280011	BUTTER KNIFE	2 DOZ.
FL-280012	BOUILLON/SOUP SPOON	2 DOZ.
FL-280015	COCKTAIL FORK	2 DOZ.
FL-280029	DEMITASSE SPOON	2 DOZ.
FL-280039	FISH KNIFE	2 DOZ.
FL-280045	LUNCH/DINNER KNIFE	1 DOZ.
FL-2800451	DINNER/EUROPEAN KNIFE	1 DOZ.



**YESTER YEAR (18/10 STAINLESS)**  
SOLD IN CASE PACKS OF DOZEN.

		CASE PACK
FL-170001	TEASPOON	1 DOZ.
FL-170005	DINNER FORK	1 DOZ.
FL-170006	SALAD FORK	1 DOZ.
FL-170007	DESSERT SPOON	1 DOZ.
FL-170011	BUTTER KNIFE	1 DOZ.
FL-170012	BOUILLON/SOUP SPOON	1 DOZ.
FL-170045	DINNER KNIFE, EURO.	1 DOZ.



**RHODIE (18/10 STAINLESS STEEL )**  
HAMMERED FINISH. SOLD IN CASE PACKS OF DOZEN.

		CASE PACK
FL-410001	TEASPOON	1 DOZ.
FL-410005	DINNER FORK	1 DOZ.
FL-410006	SALAD FORK	1 DOZ.
FL-410007	DESSERT SPOON	1 DOZ.
FL-410010	BUTTER SPREADER	1 DOZ.
FL-410012	BOUILLON SPOON	1 DOZ.
FL-410045	DINNER KNIFE	1 DOZ.



**PEARLS (18/10 STAINLESS STEEL )**  
SOLD IN CASE PACKS OF DOZEN.

		CASE PACK
FL-420001	TEASPOON	1 DOZ.
FL-420005	DINNER FORK	1 DOZ.
FL-420006	SALAD FORK	1 DOZ.
FL-420007	DESSERT SPOON	1 DOZ.
FL-420011	BUTTER KNIFE	1 DOZ.
FL-420029	DEMI SPOON	1 DOZ.
FL-420045	DINNER KNIFE	1 DOZ.



**ASH (18/10 STAINLESS)**

THIS FORGED FLATWARE IS MADE FROM 18/10 STAINLESS STEEL AND HAS A BLACK HANDLE. THE UNIQUE LOOK WILL ADD A GREAT INTEREST TO YOUR TABLE OR EVENT. SENIOR PROMS, WEDDINGS AND ENGAGEMENT PARTIES. SOLD IN CASE PACKS OF DOZEN.

	CASE PACK
FL-580001 TEASPOON	1 DOZ.
FL-580005 DINNER FORK	1 DOZ.
FL-580006 SALAD FORK	1 DOZ.
FL-580007 DESSERT SPOON	1 DOZ.
FL-580045 DINNER KNIFE	1 DOZ.



**TRIM (18/10 STAINLESS)**

SOLD IN CASE PACKS OF DOZEN.

	CASE PACK
FL-160001 TEASPOON	1 DOZ.
FL-160003 SERVING SPOON	1 DOZ.
FL-160005 DINNER FORK	1 DOZ.
FL-160006 SALAD FORK	1 DOZ.
FL-160007 DESSERT SPOON	1 DOZ.
FL-160011 BUTTER KNIFE	1 DOZ.
FL-160012 BOUILLON SPOON	1 DOZ.
FL-160015 COCKTAIL FORK	1 DOZ.
FL-160017 COLD MEAT FORK	1 DOZ.
FL-160022 STEAK KNIFE	1 DOZ.
FL-160029 DEMITASSE SPOON	1 DOZ.
FL-160045 LUNCH/DINNER KNIFE	1 DOZ.
FL-1600451 DINNER/EURO. KNIFE	1 DOZ.



**STIXS (18/10 STAINLESS STEEL)**

PATTERN HAS A TALL AND SLEEK HANDLE WITH BRANCH CHARACTERISTICS. SOLD IN CASE PACKS OF DOZEN.

	CASE PACK
FL-400001 TEASPOON	1 DOZ.
FL-400005 DINNER FORK	1 DOZ.
FL-400006 SALAD FORK	1 DOZ.
FL-400007 DESSERT SPOON	1 DOZ.
FL-400011 BUTTER KNIFE	1 DOZ.
FL-400029 DEMI SPOON	1 DOZ.
FL-400045 DINNER KNIFE	1 DOZ.



**ROLLING SWIRL (STAINLESS)**

SOLD IN CASE PACKS OF DOZEN.

	CASE PACK
FL-230001 TEASPOON	2 DOZ.
FL-230005 DINNER FORK	1 DOZ.
FL-230006 SALAD FORK	2 DOZ.
FL-230007 DESSERT SPOON	1 DOZ.
FL-230011 BUTTER KNIFE	2 DOZ.
FL-230012 BOUILLON/SOUP SPOON	2 DOZ.
FL-230015 COCKTAIL FORK	2 DOZ.
FL-230029 DEMITASSE SPOON	2 DOZ.
FL-2300451 DINNER/EUROPEAN KNIFE	1 DOZ.



**ROMAN (18/10 STAINLESS)**

SOLD IN CASE PACKS OF DOZEN.

	CASE PACK
FL-370001 TEASPOON SPOON	1 DOZ.
FL-370003 TABLE SERVING SPOON	1 DOZ.
FL-370004 ICE TEASPOON	1 DOZ.
FL-370006 SALAD FORK	1 DOZ.
FL-370007 SOUP/DESSERT SPOON	1 DOZ.
FL-370011 BUTTER KNIFE	1 DOZ.
FL-370015 OYSTER FORK	1 DOZ.
FL-370022 STEAK KNIFE	1 DOZ.
FL-370029 DEMITASSE SPOON	1 DOZ.
FL-3700451 EURO. DINNER KNIFE	1 DOZ.
FL-3700051 EURO. DINNER FORK	1 DOZ.



**SMOOTH (STAINLESS)**

SOLD IN CASE PACKS OF DOZEN.

	CASE PACK
FL-220001 TEASPOON	2 DOZ.
FL-220003 SERVING SPOON	1 DOZ.
FL-220004 ICED TEA SPOON	2 DOZ.
FL-220005 DINNER FORK	1 DOZ.
FL-220006 SALAD FORK	2 DOZ.
FL-220007 DESSERT SPOON	1 DOZ.
FL-220011 BUTTER KNIFE	2 DOZ.
FL-220012 BOUILLON/SOUP SPOON	2 DOZ.
FL-220015 COCKTAIL FORK	2 DOZ.
FL-220017 MEAT FORK	1 DOZ.
FL-220029 DEMITASSE SPOON	2 DOZ.
FL-220045 LUNCH/DINNER KNIFE	1 DOZ.
FL-2200451 DINNER/EUROPEAN KNIFE	1 DOZ.



**VESTIGE™ (18/10 STAINLESS STEEL)**

EXTRA HEAVY WEIGHT. THE TOPS OF THE PATTERN ARE SHINY MIRROR POLISH FINISH. COMMERCIAL DISHWASHER SAFE.

	CASE PACK
FL-10401 7" TEASPOON	1 DOZ.
FL-10403 8 1/2" SERVING SPOON	1 DOZ.
FL-10404 7" ICED TEASPOON	1 DOZ.
FL-10405 7 1/2" DINNER FORK	1 DOZ.
FL-104051 8 1/5" EURO DINNER FORK	1 DOZ.
FL-10406 7 1/4" SALAD/DESSERT FORK	1 DOZ.
FL-10407 7 3/4" DESSERT SPOON	1 DOZ.
FL-10411 8" BUTTER KNIFE	1 DOZ.
FL-10412 7 1/2" BOUILLON SPOON	1 DOZ.
FL-10415 5 3/4" COCKTAIL FORK	1 DOZ.
FL-10429 4 1/2" DEMITASSE SPOON	1 DOZ.
FL-10445 8 1/2" DINNER KNIFE	1 DOZ.
FL-104451 9 3/4" EURO DINNER KNIFE	1 DOZ.



**CONDE (18/8 STAINLESS)**

HAMMERED EDGE. SOLD IN CASE PACKS OF DOZEN.

	CASE PACK
FL-92601 TEASPOON	1 DOZ.
FL-92605 DINNER FORK	1 DOZ.
FL-92606 SALAD FORK	1 DOZ.
FL-92607 DESSERT SPOON	1 DOZ.
FL-92610 BUTTER SPREADER	1 DOZ.
FL-92615 COCKTAIL FORK	1 DOZ.
FL-92629 DEMI SPOON	1 DOZ.
FL-92645 DINNER KNIFE	1 DOZ.



**FIRE COLLECTION (18/10 STAINLESS)**

SOLD IN CASE PACKS OF DOZEN.

	CASE PACK
FL-524001 TEASPOON	1 DOZ.
FL-524005 DINNER FORK	1 DOZ.
FL-524006 SALAD FORK	1 DOZ.
FL-524007 DESSERT SPOON	1 DOZ.
FL-524012 BOUILLON SPOON	1 DOZ.
FL-524015 OYSTER FORK	1 DOZ.
FL-524029 AD COFFEE CUP SPOON	1 DOZ.
FL-524045 DINNER KNIFE	1 DOZ.

# FLATWARE



**PVD BLACK SEMI™ (18/10 STAINLESS STEEL)**  
THE 18/10 STAINLESS STEEL PATTERN IS PVD COATED IN BLACK.  
SOLD BY THE DOZEN ONLY.

		CASE PACK
FLB-0901	5 1/2" TEASPOON	1 DOZ.
FLB-0905	7 3/8" DINNER FORK	1 DOZ.
FLB-09051	8 1/4" EURO DINNER FORK	1 DOZ.
FLB-0907	7 1/4" DESSERT SPOON	1 DOZ.
FLB-0912	7" BOUILLON SPOON	1 DOZ.
FLB-0945	9" DINNER KNIFE	1 DOZ.



**PVD ROSE GOLD SEMI™ (18/10 STAINLESS STEEL)**  
THE 18/10 STAINLESS STEEL PATTERN IS PVD COATED IN ROSE GOLD.  
SOLD BY THE DOZEN ONLY.

		CASE PACK
FLRG-0901	5 1/2" TEASPOON	1 DOZ.
FLRG-0905	7 3/8" DINNER FORK	1 DOZ.
FLRG-09051	8 1/4" EURO DINNER FORK	1 DOZ.
FLRG-0907	7 1/4" DESSERT SPOON	1 DOZ.
FLRG-0912	7" BOUILLON SPOON	1 DOZ.
FLRG-0945	9" DINNER KNIFE	1 DOZ.



**PVD GOLD COLGATE™ (18/10 STAINLESS STEEL)**  
THE 18/10 STAINLESS STEEL AND THEN COATED IN PVD GOLD.  
SOLD BY THE DOZEN ONLY.

		CASE PACK
FLG-2701	6 1/2" TEASPOON	1 DOZ.
FLG-2705	7 1/2" DINNER FORK	1 DOZ.
FLG-27051	8 1/8" EURO DINNER FORK	1 DOZ.
FLG-2707	7 1/2" DESSERT SPOON	1 DOZ.
FLG-2712	6 1/4" BOUILLON SPOON	1 DOZ.
FLG-2745	8 5/8" DINNER KNIFE	1 DOZ.



## MANHATTAN COLLECTION (IONIC PLATING/PVD COATED)

- MADE OF 18/10 STAINLESS STEEL WHICH IS THEN PLATED USING A PROCESS CALLED IONIC PLATING
- COMMERCIAL DISHWASHER SAFE
- AVAILABLE IN VARIETY OF UNIQUE COLORS AND MATTE OR HIGH POLISH FINISHES
- EXTRA HEAVY DUTY CONSTRUCTION
- SMOOTH FLAT BOTTOM HANDLE OFFERS MODERN TOUCH



### MANHATTAN RAINBOW FINISH

		CASE PACK
FL-3601RB	6 1/2" TEASPOON	1 DOZ.
FL-36051RB	8 3/8" EUROPEAN DINNER FORK	1 DOZ.
FL-3606RB	6 3/4" SALAD FORK	1 DOZ.
FL-3607RB	7 3/4" DESSERT SPOON	1 DOZ.
FL-3611RB	6 5/8" BUTTER KNIFE	1 DOZ.
FL-3612RB	6 3/8" BOUILLON SPOON	1 DOZ.
FL-3615RB	5 3/4" OYSTER FORK	1 DOZ.
FL-3629RB	4 7/8" DEMITASSE SPOON	1 DOZ.
FL-36451RB	9" EUROPEAN DINNER KNIFE, SH	1 DOZ.

### MANHATTAN GOLD FINISH

		CASE PACK
FL-3601G	6 1/2" TEASPOON	1 DOZ.
FL-36051G	8 3/8" EUROPEAN DINNER FORK	1 DOZ.
FL-3606G	6 3/4" SALAD FORK	1 DOZ.
FL-3607G	7 3/4" DESSERT SPOON	1 DOZ.
FL-3611G	6 5/8" BUTTER KNIFE	1 DOZ.
FL-3612G	6 3/8" BOUILLON SPOON	1 DOZ.
FL-3615G	5 3/4" OYSTER FORK	1 DOZ.
FL-3629G	4 7/8" DEMITASSE SPOON	1 DOZ.
FL-36451G	9" EUROPEAN DINNER KNIFE, SH	1 DOZ.

### MANHATTAN ROSE GOLD FINISH

		CASE PACK
FL-3601RG	6 1/2" TEASPOON	1 DOZ.
FL-36051RG	8 3/8" EUROPEAN DINNER FORK	1 DOZ.
FL-3606RG	6 3/4" SALAD FORK	1 DOZ.
FL-3607RG	7 3/4" DESSERT SPOON	1 DOZ.
FL-3611RG	6 5/8" BUTTER KNIFE	1 DOZ.
FL-3612RG	6 3/8" BOUILLON SPOON	1 DOZ.
FL-3615RG	5 3/4" OYSTER FORK	1 DOZ.
FL-3629RG	4 7/8" DEMITASSE SPOON	1 DOZ.
FL-36451RG	9" EUROPEAN DINNER KNIFE, SH	1 DOZ.

### MANHATTAN BLACK FINISH

		CASE PACK
FL-3601B	6 1/2" TEASPOON	1 DOZ.
FL-36051B	8 3/8" EUROPEAN DINNER FORK	1 DOZ.
FL-3606B	6 3/4" SALAD FORK	1 DOZ.
FL-3607B	7 3/4" DESSERT SPOON	1 DOZ.
FL-3611B	6 5/8" BUTTER KNIFE	1 DOZ.
FL-3612B	6 3/8" BOUILLON SPOON	1 DOZ.
FL-3615B	5 3/4" OYSTER FORK	1 DOZ.
FL-3629B	4 7/8" DEMITASSE SPOON	1 DOZ.
FL-36451B	9" EUROPEAN DINNER KNIFE, SH	1 DOZ.
FL-36451BM	9" EUROPEAN DINNER KNIFE, SH	1 DOZ.



### MANHATTAN (18/10 STAINLESS)

		CASE PACK
FL-3601	6 1/2" TEASPOON	1 DOZ.
FL-36051	8 3/8" EUROPEAN DINNER FORK	1 DOZ.
FL-3606	6 3/4" SALAD FORK	1 DOZ.
FL-3607	7 3/4" DESSERT SPOON	1 DOZ.
FL-3611	6 5/8" BUTTER KNIFE	1 DOZ.
FL-3612	6 3/8" BOUILLON SPOON	1 DOZ.
FL-3615	5 3/4" OYSTER FORK	1 DOZ.
FL-3629	4 7/8" DEMITASSE SPOON	1 DOZ.
FL-36451	9" EUROPEAN DINNER KNIFE, SH	1 DOZ.

### MANHATTAN GOLD MATTE FINISH

		CASE PACK
FL-3601GM	6 1/2" TEASPOON	1 DOZ.
FL-36051GM	8 3/8" EUROPEAN DINNER FORK	1 DOZ.
FL-3606GM	6 3/4" SALAD FORK	1 DOZ.
FL-3607GM	7 3/4" DESSERT SPOON	1 DOZ.
FL-3611GM	6 5/8" BUTTER KNIFE	1 DOZ.
FL-3612GM	6 3/8" BOUILLON SPOON	1 DOZ.
FL-3615GM	5 3/4" OYSTER FORK	1 DOZ.
FL-3629GM	4 7/8" DEMITASSE SPOON	1 DOZ.
FL-36451GM	9" EUROPEAN DINNER KNIFE, SH	1 DOZ.

### MANHATTAN ROSE GOLD MATTE FINISH

		CASE PACK
FL-3601RGM	6 1/2" TEASPOON	1 DOZ.
FL-36051RGM	8 3/8" EUROPEAN DINNER FORK	1 DOZ.
FL-3606RGM	6 3/4" SALAD FORK	1 DOZ.
FL-3607RGM	7 3/4" DESSERT SPOON	1 DOZ.
FL-3611RGM	6 5/8" BUTTER KNIFE	1 DOZ.
FL-3612RGM	6 3/8" BOUILLON SPOON	1 DOZ.
FL-3615RGM	5 3/4" OYSTER FORK	1 DOZ.
FL-3629RGM	4 7/8" DEMITASSE SPOON	1 DOZ.
FL-36451RGM	9" EUROPEAN DINNER KNIFE, SH	1 DOZ.

### MANHATTAN BLACK MATTE FINISH

		CASE PACK
FL-3601BM	6 1/2" TEASPOON	1 DOZ.
FL-36051BM	8 3/8" EUROPEAN DINNER FORK	1 DOZ.
FL-3606BM	6 3/4" SALAD FORK	1 DOZ.
FL-3607BM	7 3/4" DESSERT SPOON	1 DOZ.
FL-3611BM	6 5/8" BUTTER KNIFE	1 DOZ.
FL-3612BM	6 3/8" BOUILLON SPOON	1 DOZ.
FL-3615BM	5 3/4" OYSTER FORK	1 DOZ.
FL-3629BM	4 7/8" DEMITASSE SPOON	1 DOZ.
FL-36451BM	9" EUROPEAN DINNER KNIFE, SH	1 DOZ.



**PRISM (18/10 STAINLESS)**  
SOLD IN CASE PACKS OF DOZEN.

		CASE PACK
FL-952001	TEASPOON	1 DOZ.
FL-952003	TABLE SPOON	1 DOZ.
FL-952004	ICED TEASPOON	1 DOZ.
FL-952005	DINNER FORK	1 DOZ.
FL-952006	SALAD/DESSERT FORK	1 DOZ.
FL-952007	SOUP/DESSERT SPOON	1 DOZ.
FL-952010	FLAT HANDLE BUTTER SPREADER	1 DOZ.
FL-952012	BOUILLON SPOON	1 DOZ.
FL-952015	OYSTER/COCKTAIL FORK	1 DOZ.
FL-952025	HOLLOW HANDLE DINNER KNIFE	1 DOZ.
FL-952029	DEMITASSE SPOON	1 DOZ.
FL-9520051	EURO DINNER FORK	1 DOZ.
FL-952045	SOLID HANDLE DINNER KNIFE	1 DOZ.
FL-9520451	EURO SOLID HDL. DINNER KNIFE	1 DOZ.



**FLORENCE (18/10 STAINLESS)**  
SOLD IN CASE PACKS OF DOZEN.

		CASE PACK
FL-852001	TEASPOON	1 DOZ.
FL-852003	TABLE SPOON	1 DOZ.
FL-852004	ICED TEASPOON	1 DOZ.
FL-852005	DINNER FORK	1 DOZ.
FL-852006	SALAD/DESSERT FORK	1 DOZ.
FL-852007	SOUP/DESSERT SPOON	1 DOZ.
FL-852010	FLAT HANDLE BUTTER SPREADER	1 DOZ.
FL-852012	BOUILLON SPOON	1 DOZ.
FL-852015	OYSTER/COCKTAIL FORK	1 DOZ.
FL-852025	HOLLOW HANDLE DINNER KNIFE	1 DOZ.
FL-852029	DEMITASSE SPOON, 4.67"	1 DOZ.
FL-8520051	EURO DINNER FORK, 8.20"	1 DOZ.
FL-852045	SOLID HANDLE DINNER KNIFE	1 DOZ.
FL-8520451	EURO SOLID HDL. DINNER KNIFE	1 DOZ.



**FOREVER (18/10 STAINLESS)**  
SOLD IN CASE PACKS OF DOZEN.

		CASE PACK
FL-659501	TEASPOON	1 DOZ.
FL-659503	TABLE SPOON	1 DOZ.
FL-659504	ICED TEASPOON	1 DOZ.
FL-659505	DINNER FORK	1 DOZ.
FL-659506	SALAD/DESSERT FORK	1 DOZ.
FL-659507	SOUP/DESSERT SPOON	1 DOZ.
FL-659512	BOUILLON SPOON	1 DOZ.
FL-659515	OYSTER/COCKTAIL FORK	1 DOZ.
FL-659529	DEMITASSE SPOON	1 DOZ.
FL-6595051	EURO DINNER FORK	1 DOZ.
FL-6595451	EURO SOLID HDL. DINNER KNIFE	1 DOZ.



**ELEGANT (18/10 STAINLESS)**  
SOLD IN CASE PACKS OF DOZEN.

		CASE PACK
FL-759501	TEASPOON	1 DOZ.
FL-759503	TABLE SPOON	1 DOZ.
FL-759504	ICED TEASPOON	1 DOZ.
FL-759505	DINNER FORK	1 DOZ.
FL-759506	SALAD/DESSERT FORK	1 DOZ.
FL-759507	SOUP/DESSERT SPOON	1 DOZ.
FL-759512	BOUILLON SPOON, 6.13"	1 DOZ.
FL-759515	OYSTER/COCKTAIL FORK	1 DOZ.
FL-759529	DEMITASSE SPOON	1 DOZ.
FL-7595051	EURO DINNER FORK	1 DOZ.
FL-7595451	EURO SOLID HDL. DINNER KNIFE	1 DOZ.



**SAFARI (18/10 STAINLESS)**  
SOLD IN CASE PACKS OF DOZEN.

		CASE PACK
FL-490001	TEASPOON	1 DOZ.
FL-490003	TABLE SPOON	1 DOZ.
FL-490004	ICED TEASPOON	1 DOZ.
FL-490005	DINNER FORK	1 DOZ.
FL-490006	SALAD/DESSERT FORK	1 DOZ.
FL-490007	SOUP/DESSERT SPOON	1 DOZ.
FL-490012	BOUILLON SPOON	1 DOZ.
FL-490015	OYSTER/COCKTAIL FORK	1 DOZ.
FL-490029	DEMITASSE SPOON	1 DOZ.
FL-4900051	EURO DINNER FORK	1 DOZ.
FL-4900451	EURO SOLID HDL. DINNER KNIFE	1 DOZ.



**VIVA (18/10 STAINLESS)**  
SOLD IN CASE PACKS OF DOZEN.

		CASE PACK
FL-758501	TEASPOON	1 DOZ.
FL-758504	ICED TEASPOON	1 DOZ.
FL-758505	DINNER FORK	1 DOZ.
FL-758506	SALAD/DESSERT FORK	1 DOZ.
FL-758507	SOUP/DESSERT SPOON	1 DOZ.
FL-758512	BOUILLON SPOON	1 DOZ.
FL-758515	OYSTER/COCKTAIL FORK	1 DOZ.
FL-758529	DEMITASSE SPOON	1 DOZ.
FL-7585051	EURO DINNER FORK	1 DOZ.
FL-7585451	EURO SOLID HDL. DINNER KNIFE	1 DOZ.



**COOPER COLLECTION (18/10 STAINLESS)**  
SOLD IN CASE PACKS OF DOZEN.

		CASE PACK
FL-416001	TEASPOON	1 DOZ.
FL-416004	ICE TEA SPOON	1 DOZ.
FL-416005	DINNER FORK	1 DOZ.
FL-416006	SALAD FORK	1 DOZ.
FL-416007	DESSERT SPOON	1 DOZ.
FL-416012	BOUILLON SPOON	1 DOZ.
FL-416015	OYSTER FORK	1 DOZ.
FL-416022	STEAK KNIFE	1 DOZ.
FL-416029	AD COFFEE CUP SPOON	1 DOZ.
FL-416045	DINNER KNIFE	1 DOZ.



**MONROE (18/10 STAINLESS)**  
SOLD IN CASE PACKS OF DOZEN.

		CASE PACK
FL-625001	TEASPOON	1 DOZ.
FL-625003	TABLE SPOON	1 DOZ.
FL-625004	ICED TEASPOON	1 DOZ.
FL-625005	DINNER FORK	1 DOZ.
FL-625006	SALAD/DESSERT FORK	1 DOZ.
FL-625007	SOUP/DESSERT SPOON	1 DOZ.
FL-625010	FLAT HANDLE BUTTER SPREADER	1 DOZ.
FL-625012	BOUILLON SPOON	1 DOZ.
FL-625015	OYSTER/COCKTAIL FORK	1 DOZ.
FL-625025	HOLLOW HANDLE DINNER KNIFE	1 DOZ.
FL-625022	SOLID HANDLE DINNER KNIFE	1 DOZ.
FL-625029	DEMITASSE SPOON	1 DOZ.
FL-6250051	EURO DINNER FORK	1 DOZ.
FL-6250451	EURO SOLID HDL. DINNER KNIFE	1 DOZ.



**ASPEN (18/10 STAINLESS)**  
SOLD IN CASE PACKS OF DOZEN.

		CASE PACK
FL-62001	TEASPOON	1 DOZ.
FL-62003	TABLE SERVING SPOON	1 DOZ.
FL-62004	ICED TEASPOON	1 DOZ.
FL-62005	DINNER FORK	1 DOZ.
FL-62006	SALAD FORK	1 DOZ.
FL-62007	SOUP/DESSERT SPOON	1 DOZ.
FL-62011	BUTTER KNIFE	1 DOZ.
FL-62012	BOUILLON SPOON	1 DOZ.
FL-62015	OYSTER FORK	1 DOZ.
FL-62022	SOLID HANDLE DINNER KNIFE	1 DOZ.
FL-62029	DEMITASSE SPOON	1 DOZ.
FL-620051	EURO DINNER FORK	1 DOZ.



**BAGUETTE (CORBY HALL) (18/10 STAINLESS STEEL)**  
MIRROR FINISH. SOLD IN CASE PACKS OF DOZEN.

CASE PACK		
FL-24501	TEASPOON	1 DOZ.
FL-24503	TABLE/SERVING SPOON	1 DOZ.
FL-24504	ICED TEA SPOON	1 DOZ.
FL-24505	DINNER FORK	1 DOZ.
FL-245051	EURO DINNER FORK	1 DOZ.
FL-24506	SALAD/DESSERT FORK	1 DOZ.
FL-24507	DESSERT/OVAL BOWL SPOON	1 DOZ.
FL-24510	BUTTER SPREADER	1 DOZ.
FL-24511	BUTTER KNIFE, SH	1 DOZ.
FL-24512	BOUILLON SPOON	1 DOZ.
FL-24514	FISH FORK	1 DOZ.
FL-24515	COCKTAIL FORK	1 DOZ.
FL-24522	STEAK KNIFE, SH	1 DOZ.
FL-24529	A.D. COFFEE SPOON	1 DOZ.
FL-24539	FISH KNIFE	1 DOZ.
FL-24545	DINNER KNIFE, SH	1 DOZ.



**OSLO (18/10 STAINLESS STEEL)**  
FORGED STAINLESS STEEL MIRROR FINISH.  
SOLD IN CASE PACKS OF DOZEN.

CASE PACK		
FL-58501	TEASPOON	1 DOZ.
FL-58503	TABLE/SERVING SPOON	1 DOZ.
FL-58504	ICED TEA SPOON	1 DOZ.
FL-58505	DINNER FORK	1 DOZ.
FL-58506	SALAD/DESSERT FORK	1 DOZ.
FL-58507	DESSERT/OVAL BOWL SPOON	1 DOZ.
FL-58510	BUTTER SPREADER, SH	1 DOZ.
FL-58511	BUTTER KNIFE, SH	1 DOZ.
FL-58512	BOUILLON SPOON	1 DOZ.
FL-58514	FISH FORK	1 DOZ.
FL-58515	COCKTAIL FORK	1 DOZ.
FL-58522	STEAK KNIFE	1 DOZ.
FL-58529	A.D. COFFEE SPOON	1 DOZ.
FL-58539	FISH KNIFE, SH	1 DOZ.
FL-58542	DESSERT KNIFE, SH	1 DOZ.
FL-58545	DINNER KNIFE, SH	1 DOZ.



**SCALA (18/10 STAINLESS STEEL)**  
MIRROR FINISH. SOLD IN CASE PACKS OF DOZEN.

CASE PACK		
FL-02501	TEASPOON	1 DOZ.
FL-02503	TABLE/SERVING SPOON	1 DOZ.
FL-02504	ICED TEA SPOON	1 DOZ.
FL-02505	DINNER FORK	1 DOZ.
FL-02506	SALAD/DESSERT FORK	1 DOZ.
FL-02507	DESSERT/OVAL BOWL SPOON	1 DOZ.
FL-02510	BUTTER SPREADER	1 DOZ.
FL-02511	BUTTER KNIFE, SH	1 DOZ.
FL-02512	BOUILLON SPOON	1 DOZ.
FL-02514	FISH FORK	1 DOZ.
FL-02515	COCKTAIL FORK	1 DOZ.
FL-02522	STEAK KNIFE, SH	1 DOZ.
FL-02529	A.D. COFFEE SPOON	1 DOZ.
FL-02539	FISH KNIFE	1 DOZ.
FL-02545	DINNER KNIFE, SH	1 DOZ.



**LAS PALMAS (18/10 STAINLESS STEEL)**  
MIRROR FINISH. SOLD IN CASE PACKS OF DOZEN.

CASE PACK		
FL-01501	TEASPOON	1 DOZ.
FL-01503	TABLE/SERVING SPOON	1 DOZ.
FL-01504	ICED TEA SPOON	1 DOZ.
FL-01505	DINNER FORK	1 DOZ.
FL-015051	EURO DINNER FORK	1 DOZ.
FL-01506	SALAD/DESSERT FORK	1 DOZ.
FL-01507	DESSERT/OVAL BOWL SPOON	1 DOZ.
FL-01510	BUTTER SPREADER	1 DOZ.
FL-01511	BUTTER KNIFE, SH	1 DOZ.
FL-01512	BOUILLON SPOON	1 DOZ.
FL-01514	FISH FORK	1 DOZ.
FL-01515	COCKTAIL FORK	1 DOZ.
FL-01522	STEAK KNIFE, SH	1 DOZ.
FL-01529	A.D. COFFEE SPOON	1 DOZ.
FL-01539	FISH KNIFE	1 DOZ.
FL-01545	DINNER KNIFE, SH	1 DOZ.



**DISTINCTION (18/10 STAINLESS STEEL)**  
MIRROR FINISH. SOLD IN CASE PACKS OF DOZEN.

CASE PACK		
FL-07501	TEASPOON	1 DOZ.
FL-07503	TABLE/SERVING SPOON	1 DOZ.
FL-07504	ICED TEA SPOON	1 DOZ.
FL-07505	DINNER FORK	1 DOZ.
FL-07506	SALAD/DESSERT FORK	1 DOZ.
FL-07507	DESSERT/OVAL BOWL SPOON	1 DOZ.
FL-07510	BUTTER SPREADER	1 DOZ.
FL-07511	BUTTER KNIFE, SH	1 DOZ.
FL-07512	BOUILLON SPOON	1 DOZ.
FL-07514	FISH FORK	1 DOZ.
FL-07515	COCKTAIL FORK	1 DOZ.
FL-07522	STEAK KNIFE, SH	1 DOZ.
FL-07529	A.D. COFFEE SPOON	1 DOZ.
FL-07539	FISH KNIFE	1 DOZ.
FL-07545	DINNER KNIFE, SH	1 DOZ.



**TROON (18/10 STAINLESS STEEL)**  
MIRROR FINISH. SOLD IN CASE PACKS OF DOZEN.

CASE PACK		
FL-35501	TEASPOON	1 DOZ.
FL-35503	TABLE/SERVING SPOON	1 DOZ.
FL-35504	ICED TEA SPOON	1 DOZ.
FL-35505	DINNER FORK	1 DOZ.
FL-35506	SALAD/DESSERT FORK	1 DOZ.
FL-35507	DESSERT/OVAL BOWL SPOON	1 DOZ.
FL-35510	BUTTER SPREADER	1 DOZ.
FL-35511	BUTTER KNIFE, SH	1 DOZ.
FL-35512	BOUILLON SPOON	1 DOZ.
FL-35514	FISH FORK	1 DOZ.
FL-35515	COCKTAIL FORK	1 DOZ.
FL-35522	STEAK KNIFE, SH	1 DOZ.
FL-35529	A.D. COFFEE SPOON	1 DOZ.
FL-35539	FISH KNIFE	1 DOZ.
FL-35545	DINNER KNIFE, SH	1 DOZ.



**YORK (18/10 STAINLESS STEEL)**  
HAMMERED PATTERN. SOLD IN CASE PACKS OF DOZEN.

CASE PACK		
FL-50501	TEASPOON	1 DOZ.
FL-50503	TABLE/SERVING SPOON	1 DOZ.
FL-50504	ICED TEA SPOON	1 DOZ.
FL-50505	DINNER FORK	1 DOZ.
FL-505051	EURO DINNER FORK	1 DOZ.
FL-50506	SALAD/DESSERT FORK	1 DOZ.
FL-50507	DESSERT/OVAL BOWL SPOON	1 DOZ.
FL-50510	BUTTER SPREADER	1 DOZ.
FL-50511	BUTTER KNIFE, SH	1 DOZ.
FL-50512	BOUILLON SPOON	1 DOZ.
FL-50514	FISH FORK	1 DOZ.
FL-50515	COCKTAIL FORK	1 DOZ.
FL-50522	OVERSIZE STEAK KNIFE, SH	1 DOZ.
FL-50529	A.D. COFFEE SPOON	1 DOZ.
FL-50539	FISH KNIFE	1 DOZ.
FL-50545	DINNER KNIFE, SH	1 DOZ.



**CHESTER (18/10 STAINLESS STEEL)**  
MIRROR FINISH. SOLD IN CASE PACKS OF DOZEN.

CASE PACK		
FL-61501	TEASPOON	1 DOZ.
FL-61503	TABLE/SERVING SPOON	1 DOZ.
FL-61504	ICED TEA SPOON	1 DOZ.
FL-61505	DINNER FORK	1 DOZ.
FL-615051	EURO DINNER FORK	1 DOZ.
FL-61506	SALAD/DESSERT FORK	1 DOZ.
FL-61507	DESSERT/OVAL BOWL SPOON	1 DOZ.
FL-61510	BUTTER SPREADER	1 DOZ.
FL-61511	BUTTER KNIFE, SH	1 DOZ.
FL-61512	BOUILLON SPOON	1 DOZ.
FL-61515	COCKTAIL FORK	1 DOZ.
FL-61522	OVERSIZE STEAK KNIFE, SH	1 DOZ.
FL-61529	A.D. COFFEE SPOON	1 DOZ.
FL-61545	DINNER KNIFE, SH	1 DOZ.



**MADISON (18/10 STAINLESS STEEL)**  
SOLD IN CASE PACKS OF DOZEN.

CASE PACK		
FL-06501	TEASPOON	1 DOZ.
FL-06503	TABLE/SERVING SPOON	1 DOZ.
FL-06504	ICED TEA SPOON	1 DOZ.
FL-06505	DINNER FORK	1 DOZ.
FL-065051	EURO DINNER FORK	1 DOZ.
FL-06506	SALAD/DESSERT FORK	1 DOZ.
FL-06507	DESSERT/OVAL BOWL SPOON	1 DOZ.
FL-06510	BUTTER SPREADER	1 DOZ.
FL-06512	BOUILLON SPOON	1 DOZ.
FL-06515	COCKTAIL FORK	1 DOZ.
FL-06522	OVERSIZE STEAK KNIFE, SH	1 DOZ.
FL-06529	A.D. COFFEE SPOON	1 DOZ.
FL-06545	DINNER KNIFE, SH	1 DOZ.



**TUDOR (18/10 STAINLESS STEEL)**  
MIRROR FINISH. SOLD IN CASE PACKS OF DOZEN.

CASE PACK		
FL-38601	TEASPOON	1 DOZ.
FL-38603	TABLE/SERVING SPOON	1 DOZ.
FL-38604	ICED TEA SPOON	1 DOZ.
FL-38605	DINNER FORK	1 DOZ.
FL-38606	SALAD/DESSERT FORK	1 DOZ.
FL-38607	DESSERT/OVAL BOWL SPOON	1 DOZ.
FL-38610	BUTTER SPREADER	1 DOZ.
FL-38611	BUTTER KNIFE, SH	1 DOZ.
FL-38612	BOUILLON SPOON	1 DOZ.
FL-38615	COCKTAIL FORK	1 DOZ.
FL-38622	STEAK KNIFE, SH	1 DOZ.
FL-38629	A.D. COFFEE SPOON	1 DOZ.
FL-38645	DINNER KNIFE, SH	1 DOZ.



MILLENNIUM (18/10 STAINLESS STEEL)  
MIRROR FINISH. SOLD IN CASE PACKS OF DOZEN.

		CASE PACK
FL-60501	TEASPOON	1 DOZ.
FL-60503	TABLE/SERVING SPOON	1 DOZ.
FL-60504	ICED TEA SPOON	1 DOZ.
FL-60505	DINNER FORK	1 DOZ.
FL-60506	SALAD/DESSERT FORK	1 DOZ.
FL-60507	DESSERT/OVAL BOWL SPOON	1 DOZ.
FL-60510	BUTTER SPREADER	1 DOZ.
FL-60512	BOUILLON SPOON	1 DOZ.
FL-60515	COCKTAIL FORK	1 DOZ.
FL-60522	OVER SIZE STEAK KNIFE, SH	1 DOZ.
FL-60529	A.D. COFFEE SPOON	1 DOZ.
FL-60545	DINNER KNIFE, SH	1 DOZ.



FRENCH LEAF (18/10 STAINLESS STEEL)  
MIRROR FINISH. SOLD IN CASE PACKS OF DOZEN.

		CASE PACK
FL-89501	TEASPOON	1 DOZ.
FL-89503	TABLE/SERVING SPOON	1 DOZ.
FL-89504	ICED TEA SPOON	1 DOZ.
FL-89505	DINNER FORK	1 DOZ.
FL-89506	SALAD/DESSERT FORK	1 DOZ.
FL-89507	DESSERT/OVAL BOWL SPOON	1 DOZ.
FL-89510	BUTTER SPREADER	1 DOZ.
FL-89511	BUTTER KNIFE, SH	1 DOZ.
FL-89512	BOUILLON SPOON	1 DOZ.
FL-89515	COCKTAIL FORK	1 DOZ.
FL-89522	STEAK KNIFE, SH	1 DOZ.
FL-89529	A.D. COFFEE SPOON	1 DOZ.
FL-89545	DINNER KNIFE, SH	1 DOZ.



BOLERO (18/10 STAINLESS STEEL)  
MIRROR FINISH. SOLD IN CASE PACKS OF DOZEN.

		CASE PACK
FL-44601	TEASPOON	1 DOZ.
FL-44603	TABLE/SERVING SPOON	1 DOZ.
FL-44604	ICED TEA SPOON	1 DOZ.
FL-44605	DINNER FORK	1 DOZ.
FL-44606	SALAD/DESSERT FORK	1 DOZ.
FL-44607	DESSERT/OVAL BOWL SPOON	1 DOZ.
FL-44611	BUTTER KNIFE, SH	1 DOZ.
FL-44612	BOUILLON SPOON	1 DOZ.
FL-44615	COCKTAIL FORK	1 DOZ.
FL-44622	STEAK KNIFE, SH	1 DOZ.
FL-44629	A.D. COFFEE SPOON	1 DOZ.
FL-44645	DINNER KNIFE, SH	1 DOZ.



METRO (18/10 STAINLESS STEEL)  
MIRROR FINISH. SOLD IN CASE PACKS OF DOZEN.

		CASE PACK
FL-63501	TEASPOON	1 DOZ.
FL-63503	TABLE/SERVING SPOON	1 DOZ.
FL-63504	ICED TEA SPOON	1 DOZ.
FL-63505	DINNER FORK	1 DOZ.
FL-63506	SALAD/DESSERT FORK	1 DOZ.
FL-63507	DESSERT/OVAL BOWL SPOON	1 DOZ.
FL-63510	BUTTER SPREADER	1 DOZ.
FL-63511	BUTTER KNIFE, SH	1 DOZ.
FL-63512	BOUILLON SPOON	1 DOZ.
FL-63515	COCKTAIL FORK	1 DOZ.
FL-63522	STEAK KNIFE, SH	1 DOZ.
FL-63529	A.D. COFFEE SPOON	1 DOZ.
FL-63545	DINNER KNIFE, SH	1 DOZ.



LAREDO (18/10 STAINLESS STEEL)  
SOLD IN CASE PACKS OF DOZEN.

		CASE PACK
FL-553001	TEASPOON	1 DOZ.
FL-553003	TABLE/SERVING SPOON	1 DOZ.
FL-553004	ICED TEA SPOON	1 DOZ.
FL-553005	DINNER FORK	1 DOZ.
FL-553006	SALAD/DESSERT FORK	1 DOZ.
FL-553007	DESSERT/OVAL BOWL SPOON	1 DOZ.
FL-553011	BUTTER KNIFE, SH	1 DOZ.
FL-553012	BOUILLON SPOON	1 DOZ.
FL-553015	COCKTAIL FORK	1 DOZ.
FL-553022	STEAK KNIFE, SH	1 DOZ.
FL-553029	A.D. COFFEE SPOON	1 DOZ.
FL-553045	DINNER KNIFE, SH	1 DOZ.



SANTA FE (18/10 STAINLESS)  
MIRROR FINISH. SOLD IN CASE PACKS OF DOZEN.

		CASE PACK
FL-580101	TEASPOON	1 DOZ.
FL-580103	TABLE/SERVING SPOON	1 DOZ.
FL-580104	ICED TEA SPOON	1 DOZ.
FL-580105	DINNER FORK	1 DOZ.
FL-580106	SALAD/DESSERT FORK	1 DOZ.
FL-580107	DESSERT/OVAL BOWL SPOON	1 DOZ.
FL-580111	BUTTER KNIFE	1 DOZ.
FL-580112	BOUILLON SPOON	1 DOZ.
FL-580115	COCKTAIL FORK	1 DOZ.
FL-580129	A.D. COFFEE SPOON	1 DOZ.
FL-580145	DINNER KNIFE	1 DOZ.



ASPEN (18/10 STAINLESS STEEL)  
MIRROR FINISH. SOLD IN CASE PACKS OF DOZEN.

		CASE PACK
FL-39601	TEASPOON	1 DOZ.
FL-39603	TABLE/SERVING SPOON	1 DOZ.
FL-39604	ICED TEA SPOON	1 DOZ.
FL-39605	DINNER FORK	1 DOZ.
FL-39606	SALAD/DESSERT FORK	1 DOZ.
FL-39607	DESSERT/OVAL BOWL SPOON	1 DOZ.
FL-39611	BUTTER KNIFE, SH	1 DOZ.
FL-39612	BOUILLON SPOON	1 DOZ.
FL-39615	COCKTAIL FORK	1 DOZ.
FL-39622	STEAK KNIFE, SH	1 DOZ.
FL-39645	DINNER KNIFE, SH	1 DOZ.



CROSSCHECK (18/10 STAINLESS)  
THIS FLATWARE PATTERN IS MADE FROM 18/10 STAINLESS STEEL AND HAS A TEXTURED HANDLE THAT WILL COMPLEMENT ANY TABLE SETTING.

		CASE PACK
FL-87501	TEASPOON	1 DOZ.
FL-87505	DINNER FORK	1 DOZ.
FL-87506	SALAD/DESSERT FORK	1 DOZ.
FL-87507	DESSERT SPOON	1 DOZ.
FL-87511	BUTTER KNIFE	1 DOZ.
FL-87515	COCKTAIL/PASTRY FORK	1 DOZ.
FL-87529	DEMI SPOON	1 DOZ.
FL-87545	DINNER KNIFE	1 DOZ.



MIAMI (18/10 STAINLESS STEEL)  
MIRROR FINISH. SOLD IN CASE PACKS OF DOZEN.

		CASE PACK
FL-48501	TEASPOON	1 DOZ.
FL-48504	ICED TEA SPOON	1 DOZ.
FL-48505	DINNER FORK	1 DOZ.
FL-48506	SALAD/DESSERT FORK	1 DOZ.
FL-48507	DESSERT/OVAL BOWL SPOON	1 DOZ.
FL-48511	BUTTER KNIFE, SH	1 DOZ.
FL-48512	BOUILLON SPOON	1 DOZ.
FL-48516	COCKTAIL FORK	1 DOZ.
FL-48529	A.D. COFFEE SPOON	1 DOZ.
FL-48545	DINNER KNIFE, SH	1 DOZ.



TOLEDO (18/10 STAINLESS STEEL)  
MIRROR FINISH. SOLD IN CASE PACKS OF DOZEN.

		CASE PACK
FL-662501	TEASPOON	1 DOZ.
FL-662503	TABLE/SERVING SPOON	1 DOZ.
FL-662504	ICED TEA SPOON	1 DOZ.
FL-662505	DINNER FORK	1 DOZ.
FL-662506	SALAD/DESSERT FORK	1 DOZ.
FL-662507	DESSERT/OVAL BOWL SPOON	1 DOZ.
FL-662510	BUTTER SPREADER	1 DOZ.
FL-662511	BUTTER KNIFE, SH	1 DOZ.
FL-662512	BOUILLON SPOON	1 DOZ.
FL-662515	COCKTAIL FORK	1 DOZ.
FL-662522	OVERSIZE STEAK KNIFE, SH	1 DOZ.
FL-662529	A.D. COFFEE SPOON	1 DOZ.
FL-662545	DINNER KNIFE, SH	1 DOZ.





**TERESA (18/10 STAINLESS STEEL)**  
MIRROR FINISH. SOLD IN CASE PACKS OF DOZEN.

		CASE PACK
FL-81501	TEASPOON	1 DOZ.
FL-81503	TABLE/SERVING SPOON	1 DOZ.
FL-81504	ICED TEA SPOON	1 DOZ.
FL-81505	DINNER FORK	1 DOZ.
FL-815051	EURO DINNER FORK	1 DOZ.
FL-81506	SALAD/DESSERT FORK	1 DOZ.
FL-81507	DESSERT/OVAL BOWL SPOON	1 DOZ.
FL-81510	BUTTER SPREADER	1 DOZ.
FL-81512	BOUILLON SPOON	1 DOZ.
FL-81514	FISH FORK	1 DOZ.
FL-81515	COCKTAIL FORK	1 DOZ.
FL-81522	STEAK KNIFE, SH	1 DOZ.
FL-81529	A.D. COFFEE SPOON	1 DOZ.
FL-81539	FISH KNIFE	1 DOZ.
FL-81545	DINNER KNIFE, SH	1 DOZ.



**TUSCANY (18/8 STAINLESS)**  
SOLD IN CASE PACKS OF DOZEN.

		CASE PACK
FL-433301	TEASPOON	1 DOZ.
FL-433303	TABLE/SERVING SPOON	1 DOZ.
FL-433305	DINNER FORK	1 DOZ.
FL-433306	SALAD/DESSERT FORK	1 DOZ.
FL-433307	SOUP/DESSERT SPOON	1 DOZ.
FL-433310	BUTTER SPREADER, F.H.	1 DOZ.
FL-433312	BOUILLON SPOON	1 DOZ.
FL-433315	OYSTER/COCKTAIL FORK	1 DOZ.
FL-433322	STEAK KNIFE, S.H.	1 DOZ.
FL-433325	DINNER KNIFE, H.H.	1 DOZ.
FL-433329	DEMI SPOON	1 DOZ.
FL-433345	DINNER KNIFE, S.H.	1 DOZ.
FL-4333051	EURE. DINNER FORK	1 DOZ.
FL-4333451	EURO. DINNER KNIFE, S.H.	1 DOZ.



**SORENTO (18/8 STAINLESS)**  
SOLD IN CASE PACKS OF DOZEN.

		CASE PACK
FL-15501	TEASPOON	1 DOZ.
FL-15504	ICED TEASPOON	1 DOZ.
FL-15505	DINNER FORK	1 DOZ.
FL-15506	SALAD/DESSERT FORK	1 DOZ.
FL-15507	SOUP/DESSERT SPOON	1 DOZ.
FL-15511	BUTTER SPREADER, S.H.	1 DOZ.
FL-15512	BOUILLON SPOON	1 DOZ.
FL-15515	OYSTER/COCKTAIL FORK	1 DOZ.
FL-15522	STEAK KNIFE, S.H.	1 DOZ.
FL-15529	DEMI SPOON	1 DOZ.
FL-155051	EURO. DINNER FORK	1 DOZ.
FL-155451	EURO. DINNER KNIFE, S.H.	1 DOZ.



**SCULP (18/10 STAINLESS)**  
SOLD IN CASE PACKS OF DOZEN.

		CASE PACK
FL-640501	TEASPOON	1 DOZ.
FL-640503	SERVING SPOON	1 DOZ.
FL-640504	ICED TEA SPOON	1 DOZ.
FL-640505	DINNER FORK	1 DOZ.
FL-640506	SALAD/DESSERT FORK	1 DOZ.
FL-640511	BUTTER KNIFE	1 DOZ.
FL-640512	BOUILLON SPOON	1 DOZ.
FL-640515	COCKTAIL FORK	1 DOZ.
FL-640529	DEMI SPOON	1 DOZ.
FL-640545	DINNER KNIFE	1 DOZ.



**WAVE (18/8 STAINLESS)**  
SOLD IN CASE PACKS OF DOZEN.

		CASE PACK
FL-33601	TEASPOON	1 DOZ.
FL-33603	TABLE/SERVING SPOON	1 DOZ.
FL-33604	ICED TEA SPOON	1 DOZ.
FL-33605	DINNER FORK	1 DOZ.
FL-33606	SALAD FORK	1 DOZ.
FL-33607	DESSERT SPOON	1 DOZ.
FL-33612	BOUILLON SPOON	1 DOZ.
FL-33645	DINNER KNIFE, 1 PC.	1 DOZ.



**DRESDEN (18/8 STAINLESS)**  
SOLD IN CASE PACKS OF DOZEN.

		CASE PACK
FL-33301	TEASPOON	1 DOZ.
FL-33305	DINNER FORK	1 DOZ.
FL-33306	SALAD FORK	1 DOZ.
FL-33307	DESSERT SPOON	1 DOZ.
FL-33312	BOUILLON SPOON	1 DOZ.
FL-33345	DINNER KNIFE, 1 PC.	1 DOZ.



**TARPON (18/8 STAINLESS)**  
SOLD IN CASE PACKS OF DOZEN.

		CASE PACK
FL-33501	TEASPOON	1 DOZ.
FL-33505	DINNER FORK	1 DOZ.
FL-33506	SALAD FORK	1 DOZ.
FL-33507	DESSERT SPOON	1 DOZ.
FL-33512	BOUILLON SPOON	1 DOZ.
FL-33545	DINNER KNIFE, 1 PC.	1 DOZ.

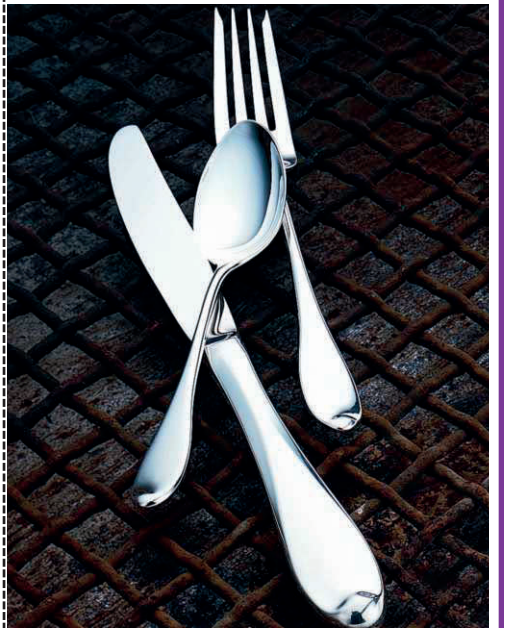

**STUDIO (18/10 STAINLESS)**  
SOLD IN CASE PACKS OF DOZEN.

		CASE PACK
FL-689001	TEASPOON	1 DOZ.
FL-689003	SERVING SPOON	1 DOZ.
FL-689004	ICED TEA SPOON	1 DOZ.
FL-689005	DINNER FORK	1 DOZ.
FL-689006	SALAD/DESSERT FORK	1 DOZ.
FL-689011	BUTTER KNIFE	1 DOZ.
FL-689012	BOUILLON SPOON	1 DOZ.
FL-689015	COCKTAIL FORK	1 DOZ.
FL-689029	DEMITASSE SPOON	1 DOZ.
FL-689045	DINNER KNIFE	1 DOZ.



**MONACO (18/10 STAINLESS STEEL)**  
FORGED STAINLESS STEEL MIRROR FINISH  
SOLD IN CASE PACKS OF DOZEN.

		CASE PACK
FL-54501	TEASPOON	1 DOZ.
FL-54503	TABLE/SERVING SPOON	1 DOZ.
FL-54504	ICED TEA SPOON	1 DOZ.
FL-54505	DINNER FORK	1 DOZ.
FL-54506	SALAD/DESSERT FORK	1 DOZ.
FL-54507	DESSERT/OVAL BOWL SPOON	1 DOZ.
FL-54511	BUTTER KNIFE, SH	1 DOZ.
FL-54512	BOUILLON SPOON	1 DOZ.
FL-54515	COCKTAIL FORK	1 DOZ.
FL-54529	A.D. COFFEE SPOON	1 DOZ.
FL-54545	DINNER KNIFE, SH	1 DOZ.



**FARMHOUSE (18/0 STAINLESS)**  
SOLD IN CASE PACKS OF DOZEN.

		CASE PACK
FL-434401	TEASPOON	3 DOZ.
FL-434405	DINNER FORK	3 DOZ.
FL-434406	SALAD FORK	3 DOZ.
FL-434407	DESSERT SPOON	3 DOZ.
FL-434412	BOUILLON SPOON	3 DOZ.
FL-434445	DINNER KNIFE LONG HANDLE	3 DOZ.



**PORTO (18/8 STAINLESS)**  
SOLD IN CASE PACKS OF DOZEN.

		CASE PACK
FL-92501	TEASPOON	3 DOZ.
FL-92504	ICED TEA SPOON	3 DOZ.
FL-92505	DINNER FORK	3 DOZ.
FL-92506	SALAD FORK	3 DOZ.
FL-92507	DESSERT SPOON	3 DOZ.
FL-92511	BREAD & BUTTER KNIFE	3 DOZ.
FL-92512	BOUILLON SPOON	3 DOZ.
FL-92515	COCKTAIL FORK	3 DOZ.
FL-92529	DEMI TASSE SPOON	3 DOZ.
FL-92545	AMERICAN DINNER KNIFE	3 DOZ.



**CHIVALRY (18/8 STAINLESS)**  
SOLD IN CASE PACKS OF DOZEN.

		CASE PACK
FL-93301	TEASPOON	1 DOZ.
FL-93305	DINNER FORK	1 DOZ.
FL-93306	UTILITY/DESSERT FORK	1 DOZ.
FL-93307	DESSERT SPOON	1 DOZ.
FL-93310	BUTTER SPREADER	1 DOZ.
FL-93315	COCKTAIL FORK	1 DOZ.
FL-93329	COCKTAIL FORK	1 DOZ.
FL-93345	DINNER KNIFE	1 DOZ.



**BISCAYNE (18/10 STAINLESS)**  
SOLD IN CASE PACKS OF DOZEN.

		CASE PACK
FL-688001	TEASPOON	1 DOZ.
FL-688003	SERVING SPOON	1 DOZ.
FL-688004	ICED TEA SPOON	1 DOZ.
FL-688005	DINNER FORK	1 DOZ.
FL-688006	SALAD/DESSERT FORK	1 DOZ.
FL-688011	BUTTER KNIFE	1 DOZ.
FL-688012	BOUILLON SPOON	1 DOZ.
FL-688015	COCKTAIL FORK	1 DOZ.
FL-688029	DEMITASSE SPOON	1 DOZ.
FL-688045	DINNER KNIFE	1 DOZ.



**MAREMMA (18/0 STAINLESS STEEL)**  
HEAVY WEIGHT.

		CASE PACK
FL-4001	TEASPOON	1 DOZ.
FL-4004	ICED TEASPOON	1 DOZ.
FL-4005	DINNER FORK	1 DOZ.
FL-40051	EURO/TABLE FORK	1 DOZ.
FL-4007	DESSERT SPOON	1 DOZ.
FL-4012	BOUILLON SPOON	1 DOZ.
FL-4045	DINNER KNIFE	1 DOZ.
FL-40451	EURO. KNIFE	1 DOZ.
FL-4099	AMERICAN 5 PC SET	1 EA.



**ATLAS (18/0 STAINLESS)**  
SOLD IN CASE PACKS OF DOZEN.

		CASE PACK
FL-87701	TEASPOON	1 DOZ.
FL-87703	TABLE/SERVING SPOON	1 DOZ.
FL-87704	ICED TEASPOON	1 DOZ.
FL-87705	DINNER FORK	1 DOZ.
FL-87706	SALAD/DESSERT FORK	1 DOZ.
FL-87707	OVAL SOUP/DESSERT SPOON	1 DOZ.
FL-87711	BUTTER KNIFE	1 DOZ.
FL-87712	BOUILLON SPOON	1 DOZ.
FL-87715	OYSTER/COCKTAIL FORK	1 DOZ.
FL-87729	A.D. COFFEE SPOON	1 DOZ.
FL-87745	1 PC. DESSERT KNIFE	1 DOZ.
FL-877011	EURO. TEASPOON	1 DOZ.
FL-877051	EURO. TABLE FORK	1 DOZ.
FL-877451	1 PC. DINNER KNIFE	1 DOZ.



**TRONADA (18/10 STAINLESS)**  
SOLD IN CASE PACKS OF DOZEN.

		CASE PACK
FL-785001	TEASPOON	1 DOZ.
FL-785003	SERVING SPOON	1 DOZ.
FL-785004	ICED TEA SPOON	1 DOZ.
FL-785005	DINNER FORK	1 DOZ.
FL-785006	SALAD/DESSERT FORK	1 DOZ.
FL-785010	BUTTER SPREADER	1 DOZ.
FL-785012	BOUILLON SPOON	1 DOZ.
FL-785015	COCKTAIL FORK	1 DOZ.
FL-785029	DEMITASSE SPOON	1 DOZ.
FL-785045	DINNER KNIFE	1 DOZ.



**KINGS (STAINLESS STEEL)**

THIS PATTERN IS MADE FROM STAINLESS STEEL AND HAS A ORNATE AND DECORATIVE HANDLE TO PROVIDE AN ELEGANT FEEL TO YOUR EVENT. SOLD BY THE DOZEN ONLY.

		CASE PACK
FL-270001	6.24" L. TEASPOON	1 DOZ.
FL-270003	9.13" L. SERVING SPOON	1 DOZ.
FL-270004	7.7" L. ICED TEASPOON	1 DOZ.
FL-270005	7.38" L. DINNER FORK	1 DOZ.
FL-2700051	8.38" L. EURO. DINNER FORK	1 DOZ.
FL-270006	7.07" L. SALAD/DESSERT FORK	1 DOZ.
FL-270007	7.19" L. DESSERT SPOON	1 DOZ.
FL-270011	6.88" L. EURO. BUTTER KNIFE	1 DOZ.
FL-270012	6.22" L. BOUILLON SPOON	1 DOZ.
FL-270015	5.63" L. COCKTAIL FORK	1 DOZ.
FL-270029	4.8" L. DEMI SPOON	1 DOZ.
FL-2700451	9.85" L. EURO. DINNER KNIFE	1 DOZ.



ONEIDA

**JADE (18/10 STAINLESS)**

SOLD IN CASE PACKS OF DOZEN.

		CASE PACK
FL-66701	TEASPOON	1 DOZ.
FL-66703	SERVING SPOON	1 DOZ.
FL-66704	ICED TEASPOON	1 DOZ.
FL-66705	DINNER FORK	1 DOZ.
FL-66706	DESSERT/SALAD FORK	1 DOZ.
FL-66707	DESSERT SPOON	1 DOZ.
FL-66711	BUTTER KNIFE	1 DOZ.
FL-66712	ROUND BOWL SOUP SPOON	1 DOZ.
FL-66715	COCKTAIL FORK	1 DOZ.
FL-66722	STEAK KNIFE	1 DOZ.
FL-66729	A.D. COFFEE SPOON	1 DOZ.
FL-66745	1 PC DINNER KNIFE	1 DOZ.



**RENOIR (18/10 STAINLESS)**

SOLD IN CASE PACKS OF DOZEN.

		CASE PACK
FL-S900	5.95" L. TEASPOON	1 DOZ.
FL-S901	6.11" L. BOUILLON SPOON	1 DOZ.
FL-S902	7.36" L. ICED TEASPOON	1 DOZ.
FL-S903	7.23" L. SOUP/DESSERT SPOON	1 DOZ.
FL-S904	8.23" L. TABLE SERVING SPOON	1 DOZ.
FL-S905	7.59" L. DINNER FORK	1 DOZ.
FL-S906	8.17" L. EURO DINNER FORK	1 DOZ.
FL-S907	7.21" L. SALAD/DESSERT FORK	1 DOZ.
FL-S908	5.61" L. COCKTAIL FORK	1 DOZ.
FL-S909	9.21" L. HH DINNER KNIFE	1 DOZ.
FL-S911	9.20" L. SH DINNER KNIFE	1 DOZ.
FL-S912	9.55" L. SH EURO DINNER KNIFE	1 DOZ.
FL-S913	6.66" L. FLAT HANDLE BUTTER SPREADER	1 DOZ.
FL-S914	9.58" L. HH EURO DINNER KNIFE	1 DOZ.
FL-S915	9.77" L. EURO SH STEAK KNIFE	1 DOZ.
FL-S916	4.66" L. DEMI SPOON	1 DOZ.



**CONTINENTAL DINING (18/10 STAINLESS)**

SOLD IN CASE PACKS OF DOZEN.

		CASE PACK
FL-620501	TEASPOON	1 DOZ.
FL-620503	SERVING SPOON	1 DOZ.
FL-620504	ICED TEA SPOON	1 DOZ.
FL-620505	DINNER FORK	1 DOZ.
FL-620506	SALAD FORK	1 DOZ.
FL-620511	BUTTER KNIFE	1 DOZ.
FL-620512	BOUILLON SPOON	1 DOZ.
FL-620515	COCKTAIL FORK	1 DOZ.
FL-620545	DINNER KNIFE	1 DOZ.

# FLATWARE BURNISHER & POLISHER

EQP-1875



### ROTARY SILVERWARE BURNISHER

ROTARY BURNISHER USES A TUMBLING MOTION TO POLISH FLATWARE QUICKLY AND EFFICIENTLY. THE HEXAGONAL DRUMS LIFT THE STEEL BALLS ON ONE SIDE, CREATING A CONTINUOUS SLIDING OF THE BALLS FROM HIGH TO LOW. THIS SLIDE ZONE GENERATES MULTIPLE IMPACTS ON THE SILVER, GENTLY ROLLING OUT SCRATCHES AND RESTORING LUSTER. THE ROTARY UNITS ARE LOADED AND UNLOADED VIA A REMOVABLE PANEL ON THE DRUM THAT IS SECURED BY EASY-TO-OPERATE HAND RELEASE LATCHES. BOTH DRUMS ARE HEAVY VINYL COATED TO PROTECT THE SILVER AND REDUCE OPERATING NOISE LEVELS. KEEP YOUR SILVER LOOKING NEW AGAIN AND AGAIN!

### STANDARD FEATURES:

- VINYL COATED HEXAGONAL ROTARY DRUM - CUSHIONS SILVER AND REDUCES NOISE. HEXAGONAL SHAPE CREATES "SLIDE ZONE" TO GENTLY ROLL AWAY SCRATCHES
- STAINLESS STEEL CONSTRUCTION - FOR LONG LIFE AND EASY MAINTENANCE IN ANY ENVIRONMENT
- QUICK-ACTING HAND RELEASE LATCHES - SPEEDS LOADING AND UNLOADING OF FLATWARE
- STANDARD 110V OPERATION - PLUGS INTO ANY STANDARD ELECTRICAL OUTLET. (50 CYCLE MODEL AVAILABLE FOR OVERSEAS USE)
- HARDENED STEEL POLISHING MEDIA - INCLUDES BURNISHING BALLS AND 1 GAL. BURNISHING LIQUID
- DETACHABLE FILL AND DRAIN HOSES - EASILY ATTACH TO FAUCET TO FILL - DRAINS INTO SINK WHEN FINISHED

EQP-1875 200 PC. SILVERWARE ROTARY BURNISHER COMES COMPLETE WITH 75 LBS OF BURNISHING BALLS AND 1 GALLON OF BURNISHING LIQUID FOR ROTARY MACHINE 20" W. x 29" L. x 30" H., 110 VT, 60 HZ, WT 265 LBS, TO REPLACE BALLS USE 3 BOXES OF EQP-1883

EQP-1880 120 PC. SILVERWARE ROTARY BURNISHER COMES COMPLETE WITH 25 LBS OF BURNISHING BALLS AND 1 GALLON OF BURNISHING LIQUID FOR ROTARY MACHINE 11.25" W. x 28" L. x 11" H., 110 VT, 60 HZ, WT 105 LBS, TO REPLACE BALLS USE 1 BOX OF EQP-1883

EQP-1883 BURNISHING BALLS 1/4" DIA. - S.S. 1 BOX, 25 LBS, FOR EQP-1880(1BOX), EQP-1875(3 BOXES)

EQP-1890 BURNISHING LIQUID - ROTARY MACHINES, 1 GALLON, CASE/4, FOR EQP-1880



EQP-1883

EQP-1890

NOTE: ALL SILVERWARE SHOULD BE THOROUGHLY WASHED AND FREE FROM FOOD, GREASE, AND DETARNISHING SOLUTION BEFORE BURNISHING. THIS IS TO PREVENT ANY KIND OF REACTION WITH THE BURNISHING BALLS. NEVER BURNISH PEWTER OR ALUMINUM.

NOTE: ROTARY BURNISHING MACHINE SHOULD USE LIQUID ROTARY BURNISHING COMPOUND. THE PROPER MIXTURE OF LIQUID COMPOUND AND WATER SHOULD BE IN THE BURNISHER AT ALL TIMES IN A QUANTITY GREAT ENOUGH TO COMPLETELY COVER THE BURNISHING BALLS. BE SURE THE COVER IS SECURELY FASTENED TO ELIMINATE EVAPORATION OF THE BURNISHING SOLUTION AND CONSEQUENTLY PROTECT THE BALLS FROM RESTING.

EQP-1880

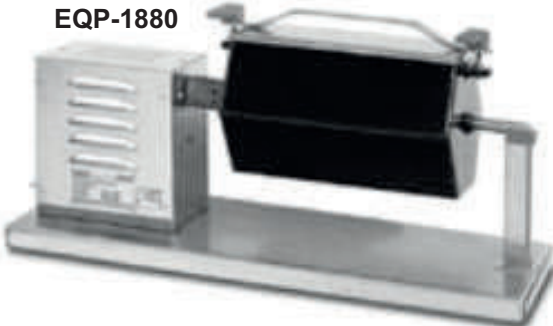

### CUTLERY DRYER-POLISHER (STAINLESS)

THE GERMICIDAL UVC-RAY LAMP STERILIZES BOTH THE CUTLERY AND THE POLISHING PRODUCT. 120 V/ 60 HZ.

#### FEATURES:

- DRIES, POLISHES AND REMOVES LIME SCALE STAINS CUTLERY AFTER WASHING
- FULLY AUTOMATIC
- STAINLESS STEEL BODY AND POLISHING TANK
- ROUNDED CUTLERY CAROUSELS, AVOIDING CUTLERY JAMS
- ECONOMY: SAVES ON PERSONAL COSTS AND QUICK RETURN OF INVESTMENT
- SPEED: HOURLY OUTPUT OF UP TO 8,000 PIECES
- HYGIENE: THE GERMICIDAL UVC-RAY LAMP STERILIZES BOTH THE CUTLERY AND THE POLISHING PRODUCT

**DRIES, POLISHES & REMOVES LIME SCALE STAINS FROM CUTLERY AFTER WASHING.**

CDP-3001 UP TO 3,000 PER HR, TABLETOP

CDP-5001 UP TO 8,000 PER HR, FLOORSTANDING

CDP-6001 UP TO 8,000 PER HR, FLOORSTANDING UNIT WITH MOTOR BRAKE AND OUTLET FAN

### COMMERCIAL GRADE CUTLERY POLISHER (POLYCARBONATE)

THIS CUTLERY POLISHER IS COMMERCIAL GRADE AND WILL HAVE YOUR CUTLERY SPOT FREE. THE POLISHER CAN POLISH BETWEEN 2,000 AND 4,000 PIECES PER HOUR, WHICH REDUCES LABOR AND ALL COSTS OF HAND POLISHING. IT IS EASY TO USE, EVEN ON WARM AND WET CUTLERY RIGHT OUT OF THE DISHWASHER. YOU SIMPLY INSERT 8 TO 10 PIECES IN THE TOP CHUTE EVERY 5 TO 10 SECONDS. THEY VIBRATE THROUGH WARMED ORGANIC GRANULATE (150-170°F) DRYING AND POLISHING THE PIECES. UV-C EXPOSURE THEN SANITIZES BEFORE IT EXITS THE POLISHER. THIS WILL CUT DOWN ON POTENTIAL BACTERIA THAT REMAINED FROM THE WASHING PROCESS. 2,000 - 4,000 PER HOUR.  
110-120V AC 50/60 Hz 630-750W 6.25AMPS

NOTE: CALIFORNIA PROP 65 WARNING: THIS PRODUCT CAN EXPOSE YOU TO BIPHENOL A, WHICH IS KNOWN TO CAUSE BIRTH DEFECTS OR OTHER REPRODUCTIVE HARM. FOR MORE INFORMATION GO TO WWW.P65WARNINGS.CA.GOV

CDP-500 25.6" x 24.5" x 19"



**NEW!**



# SALT & PEPPER SHAKERS



**MINI CUBE SALT & PEPPER SHAKERS**  
SOLD AS A SET OF 12.

SP-25 CHROMEPLATE CAP, 0.5 OZ., 2 1/8" H. x 1 1/8" W.  
SP-25-CAP CHROMEPLATED CAPS ONLY FOR SP-25  
SPG-25 GOLD BULLET CAP, 0.5 OZ., 2 1/8" H. x 1 1/8" W.



**TOWER STYLE SALT & PEPPER SHAKERS**  
SOLD AS A SET OF 12.  
2" x 2" x 4.5"

SP-4021 CHROMEPLATE CAP 1 OZ., SHAKER  
PT-4021 CHROMEPLATE CAP FOR SP-4021  
SPG-4021 GOLD BULLET CAP 1 OZ., SHAKER



**SALT & PEPPER SETS (HAMMERED METAL)**

THESE SALT AND PEPPER DISHES ARE JUST WHAT YOU NEED.  
SOLD BY THE CASE PACKS ONLY. 2 OZ., 1 3/4" DIA. X 2 3/4" H.

**NEW!**



**SALT & PEPPER SHAKERS**  
SQUARE CHROME MUSHROOM STYLE TOP. SOLD BY ONE DOZEN ONLY!

SP-4009 2 OZ.

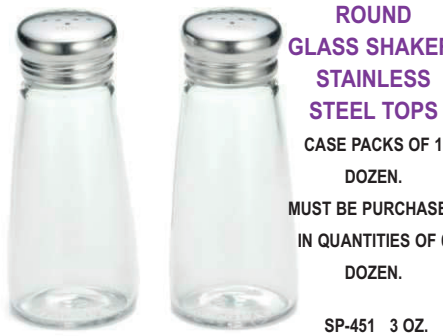

**ROUND GLASS SHAKER, STAINLESS STEEL TOPS**

CASE PACKS OF 1 DOZEN.  
MUST BE PURCHASED IN QUANTITIES OF 6 DOZEN.

SP-451 3 OZ.

		CASE PACK
SP-360	BLACK HAMMERED	12
SP-361	GOLD HAMMERED	12
SP-362	WHITE HAMMERED	12
SP-363	REPLACEMENT STOPPERS, BLACK	25
SP-364	REPLACEMENT STOPPERS, CLEAR	25



**BEEHIVE SALT & PEPPER SHAKERS**  
SOLD IN CASE PACK OF 24 EACH ONLY!

SP-774 2 OZ.



**PETITE MINI SALT & PEPPER SHAKERS**  
MINI CUBE STYLE, STAINLESS STEEL TOPS. MUST BUY IN SETS OF 12.

SP-804 0.5 OZ., 2" H.



**MASON JAR SALT OR PEPPER SHAKER W/METAL LID**

THEY COME WITH A METAL LID AND CAN HOLD 4 OZ PER SHAKER. THEY CAN EVEN BE USED AS A SHAKER FOR CHEESE, SUGAR, CINNAMON, OR ANYTHING YOU WILL NEED.

SP-475 4 OZ.



**SALT & PEPPER SHAKERS**  
NOSTALGIA STYLE SHAKERS WITH 18/8 STAINLESS STEEL TOP. 3 1/8" HEIGHT. SOLD IN CASE PACKS OF 6 DOZEN.

SP-1960 1.5 OZ.



**HAMMERED SALT & PEPPER SHAKER**  
SOLD IN CASE PACK OF 12 EACH ONLY!

SP-772 2.5 OZ.  
1 3/4" DIA. X 2 1/2" H.



**DICE SALT AND PEPPER SHAKERS (NICKELPLATE)**  
SOLD AS A SET OF 2.

SP-80491 1.5"



**SALT & PEPPER SHAKERS (STAINLESS)**  
BRUSHED FINISH STAINLESS.  
SOLD AS SETS OF 2.

SP-2990 3" H.



**SQUARE SALT & PEPPER SHAKERS SET (STAINLESS STEEL)**  
SOLD IN CASE PACKS OF 6 SET ONLY.

SP-206 1.5 OZ.



**SALT AND PEPPER SHAKERS SET (STAINLESS STEEL)**  
MUST BUY 6 SETS.

SP-201 2 OZ.



**PANELED GLASS SHAKER, CHROMEPLATED ABS TOPS**

CASE PACKS OF 1 DOZEN.  
3 OZ. CAPACITY

SP-452



**METRO GLASS SHAKER, CHROMEPLATED TOPS**

CASE PACKS OF 1 DOZEN.  
MUST BE PURCHASED IN QUANTITIES OF 2 DOZEN.

SP-450 2 OZ.



**MARBELLA SHAKERS**  
MADE FROM GREEN TINTED GLASS. ABS TOPS. SOLD IN CASE PACKS OF 2 DOZEN ONLY.

SP-615 3 OZ.



**SALT & PEPPER SHAKERS, GLASS WITH METAL TOP CONTINENTAL**  
SOLD IN CASES OF 1 DOZEN ONLY (12 TOTAL SHAKERS, OR 6 SETS)

SP-12866 4" H



**CONICAL SALT & PEPPER SHAKERS (STAINLESS STEEL)**  
SOLD IN CASE PACK OF 6 SET ONLY.

SP-207 1 OZ. CAPACITY 3" H.

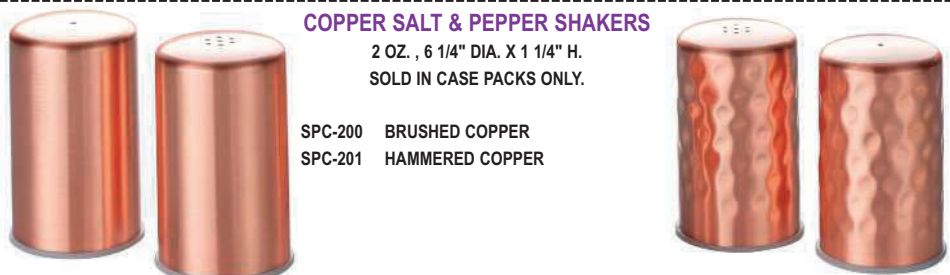

**COPPER SALT & PEPPER SHAKERS**  
2 OZ., 6 1/4" DIA. X 1 1/4" H. SOLD IN CASE PACKS ONLY.

SPC-200 BRUSHED COPPER  
SPC-201 HAMMERED COPPER



**SALT AND PEPPER SHAKERS (PORCELAIN)**  
MUST BUY 6 SETS.

SP-202 1 1/2 OZ. ROUND  
SP-203 2 OZ. ANGLED  
SP-204 2 OZ. SQUARE  
SP-205 2 OZ. SLANTED



**SALT & PEPPER SHAKER**  
SOLD IN CASE PACKS OF 36 EACH ONLY!

SP-773 1/2 OZ. CAPACITY 1 3/4" DIA. X 4" H.

# SALT & PEPPER SHAKERS & CONDIMENT SUPPLIES



**SALT & PEPPER SETS, VINTAGE**  
SOLD IN CASE PACKS OF 12.

SP-330	RIBBED ROUND	2 OZ., 1 1/2" DIA. X 4 1/2" H.
SP-331	ROUND	2 OZ., 1 1/2" DIA. X 4 1/2" H.
SP-332	RIBBED SQUARE	2 OZ., 2" SQUARE X 2 1/2" H.
SP-333	SQUARE	2 OZ., 2" SQUARE X 2 1/2" H.
SP-334	REPLACEMENT CAP	1 1/2" DIA. X 1/2" H. FOR SP-330, SP-331, SP-332, OR SP-334



**MASON JAR SHAKER (GLASS WITH STAINLESS STEEL TOP)**  
SOLD IN CASE PACK OF 1 DOZEN.  
SP-477 38 OZ.



**SALT/PEPPER SHAKER ABS TOP**  
THESE 3 OZ. SALT/PEPPER SHAKERS FEATURE AN ABS TOP AND ARE MADE FROM GREEN TINTED GLASS. SOLD IN CASES OF 2 DOZEN (24 PIECES) ONLY!  
SP-615 3 OZ. CAPACITY



**CONICAL SALT & PEPPER SHAKERS (STAINLESS STEEL)**  
SOLD IN CASE PACK OF 6 SET ONLY.  
SP-208  
1.5 OZ. CAPACITY  
6.75" H.



**SALT & PEPPER SHAKER SET (PORCELAIN)**  
SOLD IN CASE PACK OF 2 DOZENS.  
SP-70055  
3 1/8" H.



**SALT & PEPPER SHAKER SET (PORCELAIN)**  
SOLD IN CASE PACK OF 1 DOZEN.  
CHI-22568  
2" DIA.



**SALT & PEPPER SET (PORCELAIN)**  
SOLD IN CASE PACK OF 1 DOZEN.  
CHI-78722  
3" H.



**WOODEN PEPPER MILLS**  
A TEMPERED STEEL GRINDING MECHANISM FOR BETTER CONSISTENCY AND DURABILITY.  
PM-990 8" HT.  
PM-991 12" HT.  
PM-992 18" HT.



**TALL SHAKERS (STAINLESS)**  
16 OZ.  
3" DIA. X 7" H.  
SOLD IN CASE PACK OF 12 EACH ONLY!  
SP-770 FINE HOLES  
SP-771 COARSE HOLES



SP-771



**WAVED EDGE SUGAR PACKET HOLDER (PORCELAIN)**  
SOLD IN CASE PACK OF 1 DOZEN.  
CHI-2371  
3 1/4" X 2 3/4" X 2 1/4"



**SUGAR PACKET HOLDERS (PLASTIC)**  
SOLD IN CASE PACKS ONLY!  
CD-204B BLACK, SET/24  
CD-204W WHITE, SET/24  
CD-659 CLEAR, 3.5" L. x 2.5" W. x 2" H., SET/12  
CD-659W WHITE, 3.5" L. x 2.5" W. x 2" H., SET/12



**ANGLED SUGAR PACKET HOLDERS (STAINLESS)**  
HAMMERED STAINLESS STEEL.  
SOLD IN CASE PACK OF 12 EACH ONLY!  
AC-14240 ROUND HOLDER 2" DIA. x 2 3/4" H.  
AC-14241 RECTANGULAR HOLDER 3 1/8" L. x 2 1/2" W. x 1 3/4" H.  
AC-14242 SQUARE HOLDER 2" SQ. x 2 3/4" H.  
AC-14238 RECTANGULAR TRAY 4.25" x 2.25" x 1" H.



**SALT & PEPPER RACK (CHROME)**  
SPR-300 5 3/4" L. X 2 1/4" W. X 12" H.



**SUGAR PACKET HOLDERS (STAINLESS)**  
SATIN FINISH STAINLESS STEEL.  
AC-14336 RECTANGULAR HOLDER 2.75" L. x 3.25" W. x 1.75" H.  
AC-14337 ROUND HOLDER 2" DIA. x 2.75" H.  
AC-14338 RECTANGULAR TRAY 4.25" L. x 2.25" W. x 1" H.  
AC-14339 SQUARE HOLDER 2" L. x 2" W. x 2.75" H.



AC-14337  
AC-14338



**COFFEE ACCESSORIES (GOLD SATIN FINISH STAINLESS STEEL)**  
THIS COLLECTION OF COFFEE ACCESSORIES IS CONTEMPORARY WITH A BEAUTIFUL SATIN GOLD FINISH. MIX AND MATCH TO FIT YOUR TABLETOP NEEDS. SOLD IN THE CASE PACKS OF 12 ONLY.  
AC-14250 CYLINDER SUGAR PACKET HOLDER, 2" DIA. X 2 3/4" H.  
AC-14251 TRAY, 4 1/4" L. X 2 1/4" W. X 1" H.  
AC-14252 SQUARE SUGAR PACKET HOLDER, 2" SQ. X 2 3/4" H.  
AC-14253 CREAMER, 4 OZ., 2 1/7" L. X 2" W. X 2 3/4" H.  
AC-14254 RECTANGULAR SUGAR PACKET HOLDER, 2 3/4" L. X 3 1/4" W. X 1 3/4" H.



**SUGAR SHAKERS/POURERS**  
6 OZ. THREADED STEEL FLAP TOP. SOLD CASE PACK OF ONE DOZEN.  
AC-4103 FLAT TOP  
AC-4104 PERFORATED TOP



**SUGAR PACKET HOLDER (GLASS)**  
AC-6238 2 1/8" H. x 4 1/4" W., SET/12.



**SUGAR PACKET HOLDERS (BLACK POWDER COATED METAL)**  
AC-7950 3" x 2 1/2" x 2"



**SUGAR PACKET HOLDERS (CHROMEPLATE)**  
SOLD IN CASE PACK OF 1 DOZEN.  
AC-201 MIRROR FINISH  
AC-202 BRUSH FINISH



**HOT PEPPER/CHEESE SHAKERS**  
6 OZ., SCREW TOP CAPS. SOLD IN ONE DOZEN ONLY!  
AC-4101 PERFORATED TOP  
AC-4102 SLOTTED TOP

# CONDIMENT SUPPLIES, & VASES

### SOPRANO SAUCE/GRAVY BOAT (MIRROR FINISH STAINLESS)

- ACSS-297 5 OZ. CAPACITY
- ACSS-298 9 OZ. CAPACITY
- ACSS-299 15 OZ. CAPACITY



GLASS SAUCE BOAT SOLD IN CASE PACKS ONLY!

- CASE PACK**
- AC-25210 2 OZ., 2 1/2" H. X 3 1/4" T. X 1 1/2" B. 1 DOZ.
  - AC-25211 6 1/2 OZ., 3 1/4" H. X 5" T. X 2 1/2" B. 1 DOZ.
  - AC-25212 11OZ., 4 1/4" H. X 6 1/2" T. X 3" B. 6 EACH

### GRAVY BOATS (STAINLESS)

- AC-4650 3 OZ.
- AC-4651 5 OZ.
- AC-4652 8 OZ.
- AC-4653 10 OZ.
- AC-4654 16 OZ.



**ECONOMY**

### BRIGHT WHITE PORCELAIN SAUCE DISH

SOLD IN THE CASE PACKS FO 2 DOZENS ONLY. **CASE PACK 2 DOZ. 2 DOZ.**

- SD-400 4 OZ SAUCE DISH, 4" L.
- SD-500 7 OZ SAUCE DISH, 5.5"L



### SAUCE BOAT (WHITE PORCELAIN)

SOLD IN CASE PACKS OF DOZENS.

- CASE PACK**
- CHI-5323 3.5 OZ. 3 DOZ.
  - CHI-5324 5.5 OZ. 3 DOZ.
  - CHI-5325 8.5 OZ. 2 DOZ.

### HAMMERED SAUCE CUPS (STAINLESS)

- ACH-100 1.5 OZ.
- ACH-101 4 OZ.



### FLUTED RAMEKINS (SUPER WHITE PORCELAIN)

SOLD IN THE CASE PACKS ONLY!

- CHI-9780 2 OZ. 4 DOZEN
- CHI-9781 3 OZ. 4 DOZEN
- CHI-9782 4 OZ. 4 DOZEN
- CHI-9783 6 OZ. 3 DOZEN



### SAUCE CUPS (18/8 STAINLESS)

SOLD IN CASE PACKS OF 1 DOZEN.

- AC-1278 1.5 OZ.
- AC-1279 2.5 OZ.



### SAUCE CUPS (STAINLESS STEEL)

- AC-836 ROUND 8 OZ. 3.5" DIA. x 2" H.
  - AC-834 ROUND 2.5 OZ. 2 1/4" DIA. x 1 3/4" H.
  - AC-838 ROUND 3.5 OZ. 3" DIA. x 1.5" H.
  - AC-840 OVAL 1.5 OZ. 2 3/4" L. x 2" W. x 1/2" H.
  - AC-842 OVAL 2.5 OZ. 3 7/8" L. x 3" W. x 7/8" H.
  - AC-844 OVAL 4 OZ. 4 5/8" L. x 3 3/4" W. x 7/8" H.
  - AC-846 SQUARE 1.5 OZ. 2 3/8" SQ. x 1" H.
  - AC-848 SQUARE 2.5 OZ. 2 3/8" SQ. x 1 3/8" H.
  - AC-922 ROUND 1.5 OZ. 2 1/4" DIA. x 1" H.
- PKG 4 DOZ.



### MELAMINE RAMEKIN RETAIL PACKS

SOLD IN THE CASE PACKS OF 1 DOZEN.

- |          |           |        |                 |       |
|----------|-----------|--------|-----------------|-------|
| CHI-5570 | 1 1/2 OZ. | 2 1/2" | FLUTED RAMEKIN  | BONE  |
| CHI-5571 | 1 1/2 OZ. | 2 1/2" | FLUTED RAMEKIN  | WHITE |
| CHI-5572 | 2 OZ.     | 2 7/8" | FLUTED RAMEKIN  | BONE  |
| CHI-5573 | 2 OZ.     | 2 7/8" | FLUTED RAMEKIN  | WHITE |
| CHI-5574 | 3 OZ.     | 3 1/8" | FLUTED RAMEKIN  | BONE  |
| CHI-5575 | 3 OZ.     | 3 1/8" | FLUTED RAMEKIN  | WHITE |
| CHI-5576 | 4 OZ.     | 3 3/8" | FLUTED RAMEKIN  | BONE  |
| CHI-5577 | 4 OZ.     | 3 3/8" | FLUTED RAMEKIN, | WHITE |
| CHI-5578 | 1 3/4 OZ. | 2 1/2" | SMOOTH RAMEKIN  | BONE  |
| CHI-5579 | 1 3/4 OZ. | 2 1/2" | SMOOTH RAMEKIN  | WHITE |
| CHI-5580 | 2 1/2 OZ. | 2 7/8" | SMOOTH RAMEKIN  | BONE  |
| CHI-5581 | 2 1/2 OZ. | 2 7/8" | SMOOTH RAMEKIN  | WHITE |
| CHI-5582 | 3 OZ.     | 3 1/8" | SMOOTH RAMEKIN  | BONE  |
| CHI-5583 | 3 OZ.     | 3 1/8" | SMOOTH RAMEKIN  | WHITE |
| CHI-5584 | 4 OZ.     | 3 3/8" | SMOOTH RAMEKIN  | BONE  |
| CHI-5585 | 4 OZ.     | 3 3/8" | SMOOTH RAMEKIN  | WHITE |



### SOPRANO 3 PC SUPREME BOWL SET

THIS STAINLESS THREE PICE BOWL IS PERFECT FOR SHRIMP COCKTAIL, OR ANY THING YOU WANT TO KEEP COLD. JUST FILL THE BOTTOM WITH ICE!

BWL-302

### OYSTER PLATE (18/8 STAINLESS)

MIRROR FINISH. AC-1927 10.5" DIA.



### SALT & PEPPER DISHES (WHITE PORCELAIN)

THESE SALT AND PEPPER DISHES ARE JUST WHAT YOU NEED. SOLD BY THE CASE PACKS ONLY.

- CASE PACK**
- SPD-500 1/2 OZ., 1 3/4" DIA. X 3/4" H., ROUND 24
  - SPD-501 1 OZ., 2 1/8" DIA. X 1" H., ROUND 12
  - SPD-502 1/2 OZ., 1 1/2" SQ. X 1 1/8" H., SQUARE 12

### 5 SECTION DIP & SERVE TRAY (STAINLESS)

THIS 15" ROUND DIP AND SERVE TRAY CAN BE USED ON ITS OWN OR IN CONJUNCTION WITH OUR CHILLING BOWL, BWL-7610

TR-7600 15" DIA.



### SEAFOOD/DIP & SERVE TRAY (STAINLESS)

THIS 15" ROUND DIP AND SERVE TRAY CAN BE USED ON ITS OWN OR IN CONJUNCTION WITH OUR CHILLING BOWL, BWL-7610

TR-7601 15" DIA.



### ESCARGOT DISH, OYSTER PLATE (SUPER WHITE PORCELAIN)

MICROWAVE/DISHWASHER/OVEN SAFE. SOLD IN CASE PACKS OF 2 DOZEN.

- CHI-5332 8 1/2" DIA. x 7 1/2" x 1 1/4" ESCARGOT DISH
- CHI-5333 9" DIA. x 9" x 1 1/4" OYSTER PLATE



CHI-5332

CHI-5333



SOPRANO BUD VASE BV-325 7.4" H.



### BUD VASES (METAL) BRUSH FINISH BUD VASES.

- AC-2023 6.5" TALL
- AC-2024 8" TALL
- AC-2025 7" TALL

AC-2025



### BUD VASE (STAINLESS)

SOLD IN CASE PACK OF 12.

- AC-14235 HAMMERED 1.75" W. x 5.25" H.
- AC-14335 SATIN FINISH 1.75" W. x 5.25" H.

**NAPKIN RINGS, NUMBER HOLDERS, & CLEANING PRODUCTS**

**MENU & CARD HOLDERS (STAINLESS)**

SOLD IN CASE PACKS OF 1 DOZEN.

MCH-550	1.5" H.	HARP CLIP
MCH-551	2.5" H.	GADROON CLIP
MCH-552	2.5" H.	ROUND CLIP
MCH-553	4" H.	ROUND CLIP
MCH-554	6" H.	ROUND CLIP
MCH-555	8" H.	ROUND CLIP
MCH-556	10" H.	ROUND CLIP
MCH-557	12" H.	ROUND CLIP
MCH-558	18" H.	ROUND CLIP



**TABLE NUMBER STANDS (CHROME PLATED STEEL)**

CHROME PLATED STEEL NUMBER STANDS  
HAVE A HIGH POLISH FINISH WITH A HEAVY BASE.

AC-7860	8" HT.
AC-7861	12" HT.
AC-7862	15" HT.
AC-7863	18" HT.

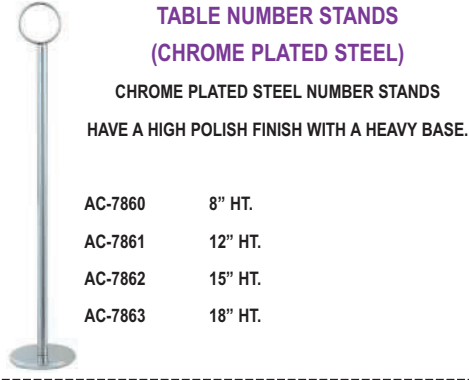

**MENU HOLDERS & CARD HOLDERS**  
CHOOSE FROM BLACK METAL OR NICKELPLATE. AVAILABLE IN HARP OR LOOP DESIGNS. CASE PACK OF 12.

AC-852	1.5" HT.	HARP	BLACK METAL
AC-853	2.5" HT.	LOOP	NICKELPLATE

**TABLE NUMBERS (HEAVY PLASTIC)**

HEAVY PLASTIC SQUARE WHITE TABLE NUMBERS, PRINTED ON BOTH SIDES. MEASURES 4" L. x 4" W.

AC-824	NO'S 101-150 (SET)
AC-825	NO'S 151-200 (SET)
AC-826	NO'S 201-250 (SET)
AC-827	NO'S 251-300 (SET)



**NUMBER TENTS (BREAK RESISTANT)**

NUMBERED ON BOTH SIDES, BLACK NUMBER ON WHITE BACKGROUND. SOLD AS PACKS OF 25.

AC-1035	SET 1-25	3" W.x 3" H.
AC-1036	SET 26-50	3" W.x 3" H.
AC-1037	SET 51-75	3" W.x 3" H.

**STARFISH NAPKIN RINGS (NICKELPLATED)**

THESE NAPKIN RINGS HAVE A BEAUTIFUL STARFISH TO ADD A BEAUTIFUL DESIGN TO YOUR TABLE SETTING. THEY ARE NICKELPLATED OVER BRASS. SOLD AS A SET OF 4

ACSS-72800 SET/4



**GOLD NAPKIN RINGS WITH CRYSTAL**

SOLD IN SETS OF FOUR ONLY.  
ACG-790 1.75" DIA.



**SILVER NAPKIN RINGS WITH CRYSTAL**

SOLD IN SETS OF FOUR ONLY.  
ACS-790 1.75" DIA.



**FLORAL NAPKIN RINGS (NICKELPLATED)**

THESE NAPKIN RINGS HAVE A BEAUTIFUL FLORAL DESIGN TO ADD A BEAUTIFUL LOOK TO YOUR TABLE SETTING. THEY ARE NICKELPLATED OVER BRASS. SOLD AS A SET OF 4

ACSS-72801 SET/4



**NAPKIN RINGS (ACRYLIC)**

1.75" DIA. x 1" W. SOLD IN CASE PACK 2 DOZEN ONLY.

**MATCHES ALL CHARGERS!**



AC-6512B	BLACK	AC-6512FG	GREEN	AC-6512R	RED
AC-6512BL	BLUE	AC-6512G	GOLD	AC-6512RB	RASPBERRY
AC-6512BR	BROWN	AC-6512PK	PINK	AC-6512S	SILVER
AC-6512C	COPPER	AC-6512PL	PURPLE	AC-6512W	WHITE

**ROLLED EDGE NAPKIN RINGS (NICKELPLATE)**

AC-74852 1" HEIGHT, SOLD AS A SET OF 4



**HAMMERED NAPKIN RINGS (STAINLESS)**

EACH RING FEATURES A HAMMERED DESIGN. SOLD AS A SET OF 4

ACSS-72653



**RESERVED SIGN**  
RESERVED SIGN WITH BLACK LETTERING.  
SG-400 2" x 4.75"

**SILVERSMITH'S GLOVES**

THESE FIVE-FINGERED GLOVES ARE CAPABLE OF WITHSTANDING SCORES OF LAUNDERINGS. GLOVES ARE SPECIALLY TREATED WITH HAGERTY DRY SILVER POLISH AND CONTAIN R-22, THE WORLDS LONGEST LASTING, PATENTED TARNISH PREVENTIVE AGENT.

HP-15010 GLOVES



**POLISHING CLOTH**

TWO PIECE POLISHING CLOTH. INNER WHITE CLOTH APPLIES A TARNISH-PREVENTING BARRIER WHILE THE OUTER GRAY CLOTH BUFFS TO BRING OUT THE LUSTER.

HP-13108 12"x15"



**CRYSTAL CARE PUMP**

CRYSTAL CLEAR IS A GREAT OPTION TO CLEAN CRYSTAL JEWELRY AND GLASS. THE FORMULA ALSO WORKS ON SMART PHONES, SMART WATCHES, AND TABLET SCREENS. THE 2.5 OZ SIZE COMES IN A PUMP SO IT IS EASY TO TAKE WITH YOU IF NEEDED. JUST APPLY A SMALL AMOUNT ON A DRY CLOTH AND WIPE, NO RINSING NEEDED. IT IS THAT EASY.

HP-90210 2.5 OZ.



**SILVERSMITH'S SPRAY POLISH**

AN ECONOMICAL, NON-ABRASIVE 8 OUNCE SPRAY DESIGNED FOR OPTIMUM POLISHING CONVENIENCE. THE ENHANCED FORMULA WORKS TO MAINTAIN YOUR SILVERS PATINA WHILE GUARDING AGAINST TARNISH FOR MONTHS, LEAVING A LUSTROUS "SHOWROOM SHINE" ON YOUR FINEST PIECES. CONTAINS R-22, THE WORLDS LONGEST LASTING, PATENTED TARNISH PREVENTIVE AGENT

HP-14201 8 OZ.



**POLISHING SPRAY BOTTLE**

SILVERSMITHS POLISH IN AN ENVIRONMENTALLY FRIENDLY FORMULA. FORMULATED FOR SILVER, SILVERPLATE, AND GOLD. IDEAL FOR CLEANING DISPLAY SILVER ITEMS WITH POROUS MATERIALS THAT CANNOT BE RINSED, AND PIECES WITH INTRICATE PATTERN-WORK.

HP-14508 8 OZ.



**SILVERSMITH'S POLISH**

A SAFE, GENTLE LOTION FORMULATED TO EFFECTIVELY CLEAN, POLISH, AND PROTECT ALL STERLING, SILVERPLATE, AND GOLD PLATED PIECES.

HP-10120 12 OZ.



**SILVERSMITH FOAM**

QUICKLY REMOVES STUBBORN TARNISH AND RESIDUE, YET IS COMPLETELY SAFE FOR ALL FINE SILVER AND GOLD.

HP-10110 18 OZ.



**ALL METAL POLISH**

THIS IS ALL METAL POLISH THAT REMOVES TARNISH, DIRT, CORROSION, GREASE, LIME AND WATER STAINS. THE POLISH HAS 3 TARNISH AND CORROSION INHIBITORS TO PROTECT YOUR METALS. THIS PRODUCT IS ALSO GOOD FOR CLEANING HARD PLASTICS, CERAMICS, PORCELAIN AND MARBLE.

HP-13120



# CANDELABRAS

**5-LIGHT OCTAGONAL STYLE CANDELABRAS (NICKELPLATE)**  
SPUN BASE BOTTOM, NON-TARNISHABLE, LOW MAINTENANCE.

LI-373 31" HT. WITHOUT BOWL  
LI-374 34" HT. WITH BOWL

**5 LIGHT CANDELABRA (NICKELPLATE)**

LI-90445  
30" TALL

**5 LIGHT CANDELABRA (WHITE POWDER COATED)**  
LIW-6931 31" H.

**LI-386**  
**FLORAL ADAPTER (NICKELPLATE)**  
9" BOW FITS 31" H. & 40" H. CANDELABRA.

**CANDELABRA (NICKELPLATED)**  
HEIGHT: 41" WITH FLORAL BOWL, 43" WITH GLASS SHADES COMES WITH CANDELABRA BOWL AND FOUR CLEAR GLASS SHADES, GLASS SHADES ARE 9" TALL NICKELPLATED FLORAL BOWL IS NOT REMOVABLE.

LI-90443 41" HIGH

**5 LIGHT SILVERPLATE CANDELABRA (SILVERPLATE)**

LI-354  
15" HT.

**5 LIGHT CANDELABRA (SILVERPLATE) BAROQUE DESIGN CANDELABRA.**

LI-370  
18" HIGH

**CRYSTAL SHADE CANDELABRA (NICKELPLATE)**

LI-72882  
21" HIGH

**CANDELABRAS (NICKELPLATE)**  
LI-6931 31" H.  
LI-6940 40" H.

**LI-386**  
**FLORAL ADAPTER (NICKELPLATE)**  
9" BOW FITS 31" H. & 40" H. CANDELABRA.

**HAMPTON CANDELABRAS (NICKELPLATE)**

LI-72740 3.5" H., CANDLE HOLDER, SET/2  
LI-72741 8.5" H., CANDLE HOLDER, SET/2  
LI-72742 12.5" H., CANDLE HOLDER, SET/2  
LI-72743 16" H., 3 LIGHT CANDELABRA  
LI-72745 16" H., 5 LIGHT CANDELABRA

**GOLD FINISH HAMPTON CANDELABRA**  
HAND WASH IN MILD DETERGENT TO MAINTAIN ITS.

LI-72743G 3 LIGHT, 16" H.  
LI-72745G 5 LIGHT, 16" H.

**CRYSTAL CANDLE HOLDER (GOLDPLATE)**  
FAUX CRYSTAL SHADES.

LI-956  
5.25" H. x 3.625" DIA.

**TEALIGHT WITH SQUARE CRYSTAL (GOLDPLATE)**  
FAUX CRYSTAL SHADES.

LI-955  
2.75" H. x 3" DIA.

**TEALIGHT HOLDER FAUX CRYSTAL SHADES.**

ACG-8050  
3" H.

**SPARKLE GLOBE TEALIGHT HOLDER FAUX CRYSTAL SHADES.**

LI-72850  
3" H.

**CRYSTAL CANDLE HOLDER (GOLDPLATE)**  
FAUX CRYSTAL SHADES.

LI-956  
5.25" H. x 3.625" DIA.

**TEALIGHT WITH SQUARE CRYSTAL (GOLDPLATE)**  
FAUX CRYSTAL SHADES.

LI-955  
2.75" H. x 3" DIA.

**GLASS CYLINDERS USES DISPOSABLE FUEL CELLS**  
FUL-17 & FUL-1565.

LI-8800  
MOCHA  
4 5/8" H x 3" DIA.

**SATIN PANEL VOTIVE LAMP**

LI-1620  
3 1/4" H. x 3 1/2" W.

**MOSAIC VOTIVES MULTI COLORED GLASS.**

LI-8810  
3 3/8" H. x 3" DIA.

**MOSAIC VOTIVES MOTHER OF PEARL.**

LI-8811  
3 3/8" H. x 3" DIA.

**CATERLITES, DISPOSABLE DISPOSABLE 5 HOUR CANDLES IN CLEAR GLASS. SOLD IN CASE PACKS OF 48 EACH.**

LI-3369

**TEALIGHT LAMPS**

LI-1607 CLEAR ICE 3 1/4" H. x 3 5/8" W.  
LI-1608 SATIN PANEL 3 1/4" H. x 3 5/8" W.

**MOTHER OF PEARL PANEL VOTIVE LAMPS**

LI-7812 3 7/8" H. x 2 11/16" SQ.  
LI-7814 5 1/4" H. x 3 1/4" SQ.

**CLEAR OPTIC GLASS PANEL VOTIVE LAMPS**

LI-7813 3 7/8" H. x 2 11/16" SQ.  
LI-7815 5 1/4" H. x 3 1/4" SQ.



# TEALIGHT HOLDERS, VOTIVES, & FUEL

### PIXEL TEALIGHT LAMPS

THE PIXEL TEALIGHT LAMPS HAVE AN INTRIGUING SCULPTURED FORM. THE MESH-LIKE EXTERIOR WILL PIXELATE CANDLELIGHT AS IT PASSES THROUGH. WORKS GREAT WITH FUEL # FUL-21362. 3" H. x 2 7/8" DIA.



- LI-5500 AMBER
- LI-5501 AQUA
- LI-5502 SATIN CRYSTA 3" H. x 2 7/8" DIA.
- LI-5503 CLEAR



**SMART CANDLE PARTY LITES**  
SMART CANDLE PARTY LITES 32 PACK. INCLUDES SHELF DISPLAY AND 32 HOLDERS WITH BATTERIES.

LI-561032  
SET/32



**SMART CANDLE TEALIGHT**  
SMART CANDLE TEALIGHT SIX PACK INCLUDES ONE BLISTER PACK AND SIX CANDLES WITH BATTERIES. ULTRA BRIGHT AMBER LED.  
LI-36846 1.5" x 1.25"  
SET/6

### FLAMELESS CANDLES (BATTERY OPERATED)

#### RECHARGEABLE TEA LIGHTS WITH PLASTIC CUPS

BATTERY OPERATED TEALIGHTS WITH YELLOW FLICKERING LIGHT. LASTS FOR 12 HOURS AFTER CHARGING. ON/OFF SWITCH ON THE BOTTOM OF EACH TEA LIGHT. SOLD COMPLETE.



- LI-CLR-6S 5 1/4" 6 PC SET
- LI-CLR-12S 4 7/8" 12 PC SET



### LIQUID WAX DISPOSABLE PLASTIC FUEL CELLS

THESE FUEL CELLS ARE DISPOSABLE. THEY BURN FOR UP TO 30 HOURS AND ARE SOLD IN CASE PACKS ONLY!

- |            |                   |          |
|------------|-------------------|----------|
| DPFUL-1000 | 10 HOUR BURN TIME | 144 EACH |
| DPFUL-1200 | 12 HOUR BURN TIME | 144 EACH |
| DPFUL-1300 | 30 HOUR BURN TIME | 48 EACH  |

### FUL-17



### FUL-36



### FUL-1565



### FUL-21362



	BURN TIMES	SIZE	CASE PACK
FUL-17	17 HR. BURN	1.5" H. x 2" DIA.,	SET/48
FUL-36	36 HR. BURN	1.75" H. x 2 9/16" DIA.	SET/24
FUL-1565	12 HR. BURN	1.5" H x 2" DIA.	SET/144
FUL-21361	8 HR. BURN	1 3/4" H. x 1 7/16" DIA., MINI FUEL CELLS	SET/90
FUL-21362	8 HR. BURN	1 3/4" H. x 1 7/16" DIA., MINI FUEL CELLS	SET/180

### DISPOSABLE FUEL CELLS

SOLD IN CASE PACKS ONLY!

### TAPER CANDLES

DRIP LESS CANDLES FIT ALL CANDELABRAS.

			CASE PACK
LI-42330	8" H.	WHITE	SET/144
LI-42331	10" H.	WHITE	SET/144
LI-42332	12" H.	WHITE	SET/144
LI-42333	15" H.	WHITE	SET/144
LI-42336	10" H.	IVORY	SET/144
LI-42337	12" H.	IVORY	SET/144
LI-42341	10" H.	RED	SET/144
LI-42342	12" H.	RED	SET/144
LI-42352	12" H.	BLUE	SET/144
LI-42357	12" H.	GREEN	SET/144

### TEALIGHT CANDLES AND VOTIVE CANDLES



	BURN TIMES		CASE PACK
LI-3370	5 HR. BURN TIME	TEA LIGHT CANDLES	CASE PACK /500
LI-3371	8 HR. BURN TIME	VOTIVE CANDLES	CASE PACK /288
LI-3372	10 HR. BURN TIME	VOTIVE CANDLES	CASE PACK /288
LI-3373	15 HR. BURN TIME	VOTIVE CANDLES	CASE PACK /144

### PILLAR CANDLES

		CASE PACK
LI-3212	3" x 3" WHITE	1 DOZ.
LI-3312	3" x 3" IVORY	1 DOZ.
LI-3512	3" x 6" WHITE	1 DOZ.
LI-3612	3" x 6" IVORY	1 DOZ.
LI-3912	3" x 9" WHITE	1 DOZ.

### VERTICAL ROD CYLINDER LAMPS



- LI-1520 RUBY 4 5/8" H. x 2 7/8" DIA.
- LI-1521 FROSTED 4 5/8" H. x 2 7/8" DIA.
- LI-1522 CLEAR 4 5/8" H. x 2 7/8" DIA.

### IVY BOWL TEALIGHT

SOLD IN CASE PACK OF 1 DOZEN.



AC-3354  
3 7/8" H. x 4" DIA. x 2 1/2" TOP x 2 1/8" BASE

### TETRA VOTIVES

SOFT SQUARE DESIGN WILL ADD AN ELEGANT AND MODERN ACCENT TO ANY TABLETOP.



- LI-6300 SPLASH BLACK 3.5" H. x 3 SQUARE
- LI-6301 SPLASH RED 3.5" H. x 3 SQUARE
- LI-6302 ANTIQUE GOLD 3.5" H. x 3 SQUARE
- LI-6303 SATIN FINISH 3.5" H. x 3 SQUARE

### VOTIVE LAMPS



- LI-1613 CHAMPAGNE JEWEL 3 9/16" H. x 3" DIA.
- LI-1614 RUBY JEWEL 3 9/16" H. x 3" DIA.
- LI-1615 CLEAR ICE 3 9/16" H. x 3" DIA.
- LI-1617 SMOKED JEWEL 3 9/16" H. x 3" DIA.
- LI-1618 SATIN CRYSTAL 3 9/16" H. x 3" DIA.

### HURRICANE SHADE (GLASS)

SOLD IN CASE PACK OF 4 EACH.



- LI-8901 14" H.  
5 1/4" T. x 5 1/4" B. x 6" D.
- LI-9860 14" H.

### CANDLESTICK LAMPS

POLISHED NICKEL BASE.



- LI-7820 CLEAR SHADE, BASE: 6 5/8" H. x 4" DIA., SHADE: 1 9/16" H. x 5 7/8" DIA.
- LI-7821 FROSTED SHADE, BASE: 6 5/8" H. x 4" DIA., SHADE: 1 9/16" H. x 5 7/8" DIA.

### FOOTED IVY BOWL TEALIGHT

SOLD IN CASE PACK OF 1 DOZEN.

5 3/8" H., 4 3/4" DIA., 3 7/8" TOP, 2 7/8" BASE  
AC-3355



### SQUARE OPTIC BLOCK LAMPS

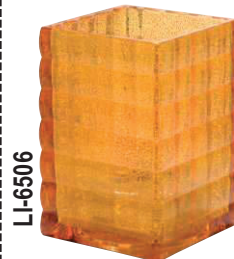

- |         |               |                        |
|---------|---------------|------------------------|
| LI-6500 | SATIN CRYSTAL | 3 3/4" H. x 2 5/6" SQ. |
| LI-6501 | AMBER         | 3 3/4" H. x 2 5/6" SQ. |
| LI-6502 | RUBY          | 3 3/4" H. x 2 5/6" SQ. |
| LI-6503 | CLEAR         | 3 3/4" H. x 2 5/6" SQ. |
| LI-6504 | RUBY JEWEL    | 3 3/4" H. x 2 5/6" SQ. |
| LI-6505 | CLEAR JEWEL   | 3 3/4" H. x 2 5/6" SQ. |
| LI-6506 | AMBER JEWEL   | 3 3/4" H. x 2 5/6" SQ. |

# DINNERWARE



CHI-5010 TRAY

## CITY SQUARE (PORCELAIN)

SUPER WHITE PORCELAIN. SOLD IN CASE PACKS ONLY!

CHI-5010 TRAY				CASE PACK
CHI-5000	CUP	8 OZ., 3 1/2" x 2 1/2"		3 DOZ.
CHI-5001	SQUARE BOWL	2 OZ., 3 1/8" x 3 1/8" x 1"		6 DOZ.
CHI-5002	SQUARE BOWL	4.5 OZ., 4" x 4" x 1 1/4"		4 DOZ.
CHI-5003	SQUARE BOWL	7 OZ., 5" x 5" x 1 3/4"		3 DOZ.
CHI-5004	SQUARE BOWL	12 OZ., 6" x 6" x 2"		3 DOZ.
CHI-5005	SQUARE BOWL	20 OZ., 7 1/4" x 7 1/4" x 2 1/4"		2 DOZ.
CHI-5006	SQUARE BOWL	36 OZ., 8 1/2" x 8 1/2" x 2 1/2"		2 DOZ.
CHI-5007	SQUARE BOWL	60 OZ., 10 3/4" x 10 3/4" x 3 1/4"		1 DOZ.
CHI-5008	SQUARE BOWL	6 OZ., 4" x 4" x 1 3/4"		4 DOZ.
CHI-5009	ROUND CUP	4 OZ., 3 1/4" x 2 3/8"		4 DOZ.
CHI-5010	TRAY FITS CHI-5001, CHI-5002, CHI-5009	12" x 4 3/4"		2 DOZ.
CHI-5012	BREAKFAST PLATE	12" x 5 1/2" x 1"		2 DOZ.
CHI-5013	3 DIVIDED BOWL	10.5 OZ., 9" x 3" x 2"		2 DOZ.
CHI-5015	TRAY, CONTEMPORARY	14"		1 DOZ.



## COOS BAY

THE COOS BAY COLLECTION HAS FOUR VIBRANT COLORS AND DESIGNS TO CHOICE FROM, OR YOU CAN MIX AND MATCH. THEY ARE OVEN SAFE UP TO 350 DEGREES F. NO MATTER WHICH PIECE OR COLOR YOU CHOICE, IT WILL SURE ADD INTERSET AND FRESH FROM THE OVEN APPEAL TO YOUR TABLE, SHARABLE APPETIZERS, OR SIDE DISHES.

			CASE PACK
CHI-4760	SQUARE PLATE, OLIVE	3 1/2 OZ., 5 1/8"	1 DOZ.
CHI-4761	SQUARE PLATE, OLIVE	11 OZ., 7 1/2"	1 DOZ.
CHI-4762	SQUARE PLATE, OLIVE	10 3/8 OZ., 10 3/8"	1 DOZ.
CHI-4763	OVAL PLATTER, CHILI	4 OZ., 7 1/4" X 4 1/8"	1 DOZ.
CHI-4764	OVAL PLATTER, CHILI	11 OZ., 10" X 5 5/8"	1 DOZ.
CHI-4765	OVAL PLATTER, CHILI	17 OZ., 11" X 6 1/2"	1 DOZ.
CHI-4766	ROUND PLATE, PUMPKIN	3 OZ., 5 1/2" DIA.	1 DOZ.
CHI-4767	ROUND PLATE, PUMPKIN	10 OZ., 7 7/8" DIA.	1 DOZ.
CHI-4768	ROUND PLATE, PUMPKIN	14 OZ., 8 1/2" DIA.	1 DOZ.
CHI-4769	RECTANGULAR PLATTER, BUTTER	5 1/2 OZ., 7 1/2" X 4 3/8"	1 DOZ.
CHI-4770	RECTANGULAR PLATTER, BUTTER	13 OZ., 9 7/8" X 5 3/4"	1 DOZ.
CHI-4771	RECTANGULAR PLATTER, BUTTER	23 OZ., 10 7/8" X 6 5/8"	1 DOZ.



## DIPLOMAT GOLD

DIPLOMAT'S ELEGANT GOLD LINES ARE MICROWAVE SAFE. SOLD IN CASE PACKS ONLY!

			CASE PACK
CHI-14090130	DENVER MUG	8 1/4 OZ.	3 DOZ.
CHI-14090374	SEVILLE GRAPEFRUIT BOWL	9.5 OZ., 7 1/4" DIA.	3 DOZ.
CHI-14090375	SEVILLE FRUIT BOWL	4.25 OZ., 5 1/2" DIA.	3 DOZ.
CHI-14090414	DURATHIM RIM SOUP BOWL	13 OZ., 9" DIA.	2 DOZ.
CHI-14090700	TEA CUP	7 3/4 OZ.	3 DOZ.
CHI-14090701	TEA SAUCER	5 3/4" DIA.	3 DOZ.
CHI-14090702	DINNER PLATE	10" DIA.	1 DOZ.
CHI-14090703	SALAD PLATE	7" DIA.	3 DOZ.
CHI-14090710	CHOP PLATE	12 1/4" DIA.	1 DOZ.
CHI-14090711	FRUIT/DESSERT BOWL	4 1/4 OZ., 5 3/4" DIA.	3 DOZ.
CHI-14090712	PLATE	6" DIA.	3 DOZ.
CHI-14090714	SALT SHAKER	2 7/8" H.	3 DOZ.
CHI-14090715	PEPPER SHAKER	2 7/8" H.	3 DOZ.
CHI-14090718	BOUILLON	7 1/2 OZ.	3 DOZ.
CHI-14090719	SAUCEBOAT	16 OZ.	1 DOZ.
CHI-14090731	PLATE, LUNCHEON	8 7/8" DIA.	2 DOZ.



The Homer Laughlin China Company®



RENTAL FAVORITES!

LIMITED LIFETIME NO CHIP WARRANTY



## RECEPTION BONE WHITE

CLASSIC OR TRADITIONAL WHITE DINNERWARE IS PREFERRED BY CATERERS. SOLD IN CASE PACK DOZENS ONLY!

			CASE PACK
CHI-47925	PLATE	6 1/8"	2 DOZ.
CHI-47929	PLATE	7 5/8"	2 DOZ.
CHI-47902	PLATE	9 1/2"	2 DOZ.
CHI-15368	PLATE	9"	2 DOZ.
CHI-47900	PLATE	10 5/8"	2 DOZ.
CHI-47913	RIM SOUP PLATE	8 5/8", 9 OZ.	2 DOZ.
CHI-10887	PASTA BOWL	11 1/4", 38 OZ.	1 DOZ.
CHI-55219	STACKING BOWL	4 3/4", 10 1/2 OZ.	3 DOZ.
CHI-47982	STACKING CUP	8 OZ.	3 DOZ.
CHI-48025	MUG	10 OZ.	3 DOZ.
CHI-47974	BOUILLON/SUGAR	7 OZ.	2 DOZ.

# DINNERWARE



### VALE

VALE OFFERS AN ORGANIC SHAPE WITH A GENTLE SLOPING FRONT EDGE. THE BRIGHT WHITE COLOR WILL ADD A TOUCH OF SOPHISTICATION AND ELEGANCE TO ANY TABLE SETTING. THE SIDE BOWLS AND COFFEE SERVICE ITEMS OFFER THE UNIQUE SHAPES AS WELL. SOLD IN THE CASE PACKS ONLY.



CHI-545411 SOUP/SALAD BOWL



CHI-545424 SUGAR POT



CHI-545413 BOUILLON



CHI-545426 CREAMER

		CASE PACK
CHI-545400	6" DIA. PLATE	2 DOZ.
CHI-545401	8" X 6.5" DIA. PLATE	1 DOZ.
CHI-545402	10 1/2" DIA. PLATE	1 DOZ.
CHI-545403	12" DIA. PLATE	6 EACH
CHI-545404	4 OZ., 5" DIA. BOWL	1 DOZ.
CHI-545405	12 OZ., 8" X 6.5" DIA. BOWL	1 DOZ.
CHI-545406	23 OZ., 10" DIA. BOWL	1 DOZ.
CHI-545407	36 OZ., 12" DIA. BOWL	1 DOZ.
CHI-545408	1.5 OZ., 4 1/2" X 3 1/4" X 1 1/2" BOWL	2 DOZ.
CHI-545409	5 OZ., 8" X 5" X 2 1/2" PASTA BOWL	1 DOZ.
CHI-545410	12 OZ., 10 1/4" X 8 1/4" PASTA/SALAD BOWL	6 EACH
CHI-545411	27 OZ., 8" X 6 3/4" SOUP/SALAD BOWL	1 DOZ.
CHI-545412	14 OZ., 7 3/4" X 4 3/4" BOWL WITH HANDLES	1 DOZ.
CHI-545413	13 OZ., 3 1/2" D. X 2 1/4" H. BOUILLON	2 DOZ.
CHI-545414	18" X 3 3/4" PLATTER	2 DOZ.
CHI-545415	11" X 5" PLATTER	1 DOZ.
CHI-545416	14 1/2" X 6 1/2" PLATTER	1 DOZ.
CHI-545417	12" X 10 1/4" PLATTER	6 EACH
CHI-545418	8 OZ., 5" D. X 3" H. CUP	1 DOZ.
CHI-545419	6 1/4" X 5" SAUCER FOR 8 OZ. CUP	1 DOZ.
CHI-545420	3 OZ., 3 3/4" D X 2 1/4" H CUP	2 DOZ.
CHI-545421	5" X 4" SAUCER FOR 3 OZ. CUP	2 DOZ.
CHI-545422	2 OZ., 3 1/2" D X 5/8" H. SAUCE DISH	3 DOZ.
CHI-545423	3" H. SALT & PEPPER SHAKER	1 DOZ.
CHI-545424	8 OZ., 4" D. X 2 1/2" H. SUGAR POT	1 DOZ.
CHI-545425	3 1/4" X 2 3/4" SUGAR PACKET HOLDER	1 DOZ.
CHI-545426	5 OZ., 4 3/4" X 2 1/4" H. CREAMER	2 DOZ.



### TEXTURED DINNERWARE

THIS BEAUTIFUL TEXTURED WHITE CHINA COLLECTION WILL GIVE YOUR TABLE A HIGH END LOOK. THEY ARE SOLD IN THE CASE PACKS ONLY AND HAS A LIFETIME MANUFACTURERS CHIP WARRANTY.

		CASE PACK
CHI-87900	6.25" ROUND PLATE	1 DOZ.
CHI-87901	9.5" ROUND PLATE	1 DOZ.
CHI-87902	10.5" ROUND PLATE	1 DOZ.
CHI-87903	9" RIM SOUP BOWL	1 DOZ.
CHI-87904	PASTA BOWL	1 DOZ.
CHI-87905	BOUILLON BOWL	1 DOZ.
CHI-87906	CAN CUP	1 DOZ.
CHI-87907	6" SAUCER FOR CAN CUP	1 DOZ.
CHI-87908	SERVING BOWL	6 EACH
CHI-87909	16" PLATTER	1 DOZ.



### SMOKE DINNERWARE

THIS BEAUTIFUL CHINA COLLECTION WILL GIVE YOUR TABLE THE LOOK OF MARBLE. THE COLLECTION HAS MANY OPTIONS FOR PLATES, BOWLS, AND PLATTERS FOR YOU TO CHOOSE FROM. THEY ARE SOLD IN THE CASE PACKS ONLY.

		CASE PACK
CHI-88000	6" ROUND COUPE PLATE	3 DOZ.
CHI-88001	8" ROUND COUPE PLATE	2 DOZ.
CHI-88002	10" ROUND COUPE PLATE	2 DOZ.
CHI-88003	12" ROUND COUPE PLATE	1 DOZ.
CHI-88004	9" ROUND COUPE BOWL	2 DOZ.
CHI-88005	10" ROUND COUPE BOWL	2 DOZ.
CHI-88006	6" OVAL COUPE PLATE	3 DOZ.
CHI-88007	8" OVAL COUPE PLATE	2 DOZ.
CHI-88008	10" OVAL COUPE PLATE	2 DOZ.
CHI-88009	12" OVAL COUPE PLATE	1 DOZ.
CHI-88010	8" OVAL COUPE BOWL	2 DOZ.
CHI-88011	10" OVAL COUPE BOWL	2 DOZ.
CHI-88012	12" OVAL COUPE BOWL	1 DOZ.
CHI-88013	8" OVAL COUPE PLATTER	2 DOZ.
CHI-88014	10" OVAL COUPE PLATTER	1 DOZ.
CHI-88015	12" OVAL COUPE PLATTER	1 DOZ.



### MID CENTURY

THIS COLLECTION IS A SIMPLE BUT ELEGANT FINE PORCELAIN. THE WHITE COLOR CAN BLEND WITH ANY TABLETOP SETTING AT A RESTAURANT, HOTEL, OR CATERING EVENT. THE COLLECTION CAN WITHSTAND DAILY USE DUE TO ITS VITRIFIED CONSTRUCTION AND ALUMINA BODY. IT IS ALSO DISHWASHER, OVEN, AND MICROWAVE SAFE WITH A 3 YEAR MANUFACTURE CHIP WARRANTY.

		CASE PACK
CHI-15000	6" DIA. PLATE	3 DOZ.
CHI-15001	8" DIA. PLATE	3 DOZ.
CHI-15002	11" DIA. PLATE	1 DOZ.
CHI-15003	32 OZ., 7.5" W. X 7.6" W. CURVED BOWL	2 DOZ.
CHI-15004	72 OZ., 9.1" W X 8.9" W CURVED BOWL	1 DOZ.
CHI-15005	8 OZ., 3.5" W. X 3.3" H. CUP	3 DOZ.
CHI-15006	6" DIA. SAUCER FOR 8 OZ. CUP	3 DOZ.



### STONEHAVEN

THIS COLLECTION ALLOWS YOU TO EXPERIENCE THE EVOLUTION OF ORGANIC DINING. STONEHAVEN IS UNLIKE ANYTHING ELSE YOU HAVE SEEN IN DINNERWARE AND OFFERS A COLLECTION THAT WILL SERVE AS YOUR CENTERPIECE OF YOUR TABLE SETTING. EACH PIECE IS ORGANIC IN SHAPE AND CAN BE USED TOGETHER OR ONE PIECE CAN BE AN ACCENT TO ANY EVENT. THIS COLLECTION IS SOLD IN THE CASE PACKS ONLY.

		CASE PACK
CHI-143000	7" OVAL PLATE	2 DOZ.
CHI-143001	12" x 9 1/2" PLATE	6 EACH
CHI-143002	14" x 3 1/2" SIDE PLATE	1 DOZ.
CHI-143003	8 OZ., 6" BOWL	1 DOZ.
CHI-143004	20 OZ., 6.5" DIA. BOWL	1 DOZ.
CHI-143006	48 OZ., 10 1/2" DIA. SALAD/PASTA BOWL	6 EACH
CHI-143007	2 OZ., 3 3/4" SAUCE DISH	3 DOZ.
CHI-143008	13 1/2" X 4 1/2" PLATTER	1 DOZ.



CHI-143000 OVAL PLATE



CHI-143001 PLATE



CHI-143002 SIDE PLATE



CHI-143003 BOWL



CHI-143007 SAUCE DISH



CHI-143008 PLATTER



### STACKED LINES

THIS COLLECTION IS MADE OF FINE PORCELAIN WITH ETCHED LINES TO CREATE A TEXTURED LOOK. THE WHITE COLOR CAN BLEND WITH ANY TABLETOP SETTING AT A RESTAURANT, HOTEL, OR CATERING EVENT. THE COLLECTION CAN WITHSTAND DAILY USE DUE TO ITS VITRIFIED CONSTRUCTION AND ALUMINA BODY. IT IS ALSO DISHWASHER, OVEN, AND MICROWAVE SAFE WITH A 3 YEAR MANUFACTURE CHIP WARRANTY.

		CASE PACK
CHI-16000	5.5" BREAD & BUTTER PLATE	3 DOZ.
CHI-16001	7.5" SALAD PLATE	2 DOZ.
CHI-16002	10" DINNER PLATE	2 DOZ.
CHI-16003	28 OZ., 7.3" W. X 2.2" H. SOUP BOWL	16 EACH
CHI-16004	48 OZ. 8" W. X 2.6" H. PASTA BOWL	8 EACH
CHI-16005	8 OZ., 3.1" W. X 3.4" H. MUG	3 DOZ.
CHI-16006	7 OZ., .54" W. X 2.76" H. CUP	3 DOZ.
CHI-16007	5.5" SAUCER FOR CUP AND MUG	3 DOZ.

# DINNERWARE



### NEW CASTLE

THIS TRADITIONAL BONE CHINA COLLECTION ENCOMPASSES BOTH STRENGTH OF BODY YET SUITABLE FOR LUXURY DINING. IT'S DISTINCTIVE CLEFT DESIGN ENHANCES THE BEAUTY OF THE PATTERN.



			CASE PACK
CHI-851441	PLATE	11.5" DIA.	1 DOZ.
CHI-851442	PLATE	10.25" DIA.	1 DOZ.
CHI-851443	PLATE	9.5" DIA.	1 DOZ.
CHI-851444	PLATE	7.5" DIA.	2 DOZ.
CHI-851449	STACK SOUP CUP	9 OZ., 4" DIA.	2 DOZ.
CHI-851453	CUP	6 OZ.	2 DOZ.
CHI-851454	SAUCER	6" DIA.	2 DOZ.



### ATHENA

THIS CLASSIC COLLECTION IS AMERICAN WHITE WITH A WIDE RIME THAT HAS A LINED EDGE. IT IS A VERSATILE AND TIMELESS LOOK TO BLEND WITH ANY DÉCOR. SOLD IN THE CASE PACKS ONLY.



CHI-62555 OVAL PLATTER

CHI-62555 SAUCER

CHI-62560 MUG

### FARMHOUSE (PORCELAIN)

THIS COLLECTION ADDS A COMPLETE FRESH FROM THE FARM LOOK TO YOUR TABLE SETTING. THE FARMHOUSE COLLECTION IS OFFERED IN BUTTER OR BLUE HEN.



CHI-62560 CUP



CHI-62559 SALAD BOWL



CHI-62571 LONG TRAY

			CASE PACK
CHI-62550	PLATE	6 3/8" DIA.	3 DOZ.
CHI-62551	PLATE	8" DIA.	3 DOZ.
CHI-62552	PLATE	9" DIA.	1 DOZ.
CHI-62553	PLATE	10 1/2" DIA.	1 DOZ.
CHI-62554	PLATE	12" DIA.	1 DOZ.
CHI-62555	OVAL PLATTER	12 1/2" X 9"	1 DOZ.
CHI-62556	FRUIT BOWL	5 OZ.	3 DOZ.
CHI-62557	BOUILLON	8 OZ.	3 DOZ.
CHI-62558	GRAPEFRUIT BOW	12 OZ.	3 DOZ.
CHI-62559	SOUP/SALAD BOWL	27 OZ.	3 DOZ.
CHI-62560	MUG	12 OZ.	3 DOZ.
CHI-62561	CUP	9 OZ.	3 DOZ.
CHI-62562	SAUCER	6 1/4"	3 DOZ.
CHI-62563	SALT SHAKER		3 DOZ.
CHI-62564	PEPPER SHAKER		1 DOZ.
CHI-62565	CREAMER	3 OZ.	3 DOZ.
CHI-62566	OATMEAL BOWL	15 OZ.	3 DOZ.
CHI-62567	BOWL	30 OZ., 7"	1 DOZ.
CHI-62568	PASTA BOWL	11"	1 DOZ.
CHI-62569	BOWL	48 OZ., 8 1/2"	1 DOZ.
CHI-62570	PIZZA PLATE	13 1/2"	6 EACH
CHI-62571	LONG TRAY	16" x 5 3/4"	1 DOZ.



CHI-116714 PLATTER



CHI-116706 RIM DEEP SOUP BOWL



CHI-116709 NAPPIE BOWL

			CASE PACK
CHI-116700	5 1/2" DIA. PLATE		3 DOZ.
CHI-116701	6 3/8" DIA. PLATE		3 DOZ.
CHI-116702	7" DIA. PLATE		3 DOZ.
CHI-116703	9 1/2" DIA. PLATE		2 DOZ.
CHI-116704	10" DIA. PLATE		1 DOZ.
CHI-116705	11 1/8" DIA. PLATE		1 DOZ.
CHI-116706	9" DIA. RIM DEEP SOUP BOWL		2 DOZ.
CHI-116707	6.5 OZ., 6 5/8" DIA. GRAPEFRUIT BOWL		3 DOZ.
CHI-116708	7 OZ., 5" DIA. FRUIT BOWL		3 DOZ.
CHI-116709	18 OZ., 5 5/8" DIA NAPPIE BOWL		3 DOZ.
CHI-116710	8 OZ., 3 5/8" DIA BOUILLON		3 DOZ.
CHI-116711	8 OZ. LOW CUP, 2 5/8" H.		3 DOZ.
CHI-116712	9 OZ., 3 3/4" H. MUG		3 DOZ.
CHI-116713	5 1/2" SAUCER (FITS BOUILLON, CUP, & MUG)		3 DOZ.
CHI-116714	9 1/4" X 6 7/8" PLATTER		2 DOZ.
CHI-116715	11 7/8" X 9 1/4" PLATTER		1 DOZ.



CHI-116712 MUG



CHI-116710 BOUILLON

# DINNERWARE



WHITE/DOUBLE GOLD BAND (PORCELAIN)

			CASE PACK
CHI-65001	DINNER PLATE	10.75" DIA.	1 DOZ.
CHI-65002	RIM SOUP PLATE	8" DIA.	1 DOZ.
CHI-65003	SALAD PLATE	7.5" DIA.	1 DOZ.
CHI-65004	CAN CUP AND SAUCER		1 DOZ.
CHI-65005	BREAD & BUTTER PLATE	6" DIA.	1 DOZ.
CHI-65007	LUNCH PLATE	9" DIA.	1 DOZ.



WHITE CHINA WITH GOLD BAND  
SOLD IN CASE PACKS ONLY!

			CASE PACK
CHI-3239	FOOTED CUP	8 OZ.	6 DOZ.
CHI-3240	SAUCER, FITS CUP CHI-3239		6 DOZ.
CHI-3241	BREAD/BUTTER PLATE	6" DIA.	6 DOZ.
CHI-3242	SALAD PLATE	8.25" DIA.	6 DOZ.
CHI-3243	DINNER PLATE	10.75" DIA.	2 DOZ.
CHI-3250	SOUP BOWL	9 OZ., 8" DIA.	6 DOZ.
CHI-3251	LUNCHEON PLATE	9" DIA.	4 DOZ.
CHI-3252	CHOP PLATE	12" DIA.	18 EA.
CHI-3253	SCREAMER	9 OZ.	3 DOZ.
CHI-3256	SUGAR BOWL WITH COVER		3 DOZ.



WHITE/DOUBLE PLATINUM BAND (PORCELAIN)

			CASE PACK
CHI-55001	DINNER PLATE	10.75" DIA.	1 DOZ.
CHI-55002	RIM SOUP PLATE	8" DIA.	1 DOZ.
CHI-55003	SALAD PLATE	7.5" DIA.	1 DOZ.
CHI-55004	CAN CUP AND SAUCER		1 DOZ.
CHI-55005	BREAD & BUTTER PLATE		2 DOZ.
CHI-55006	CHARGER	12" DIA.	1 DOZ.
CHI-55007	LUNCH PLATE	9" DIA.	1 DOZ.



WHITE CHINA WITH PLATINUM BAND  
SOLD IN CASE PACKS ONLY!

			CASE PACK
CHI-3261	LUNCHEON PLATE	9"	6 DOZ.
CHI-3262	FOOTED CUP	8" OZ.	6 DOZ.
CHI-3263	SAUCER, FITS CUP CHI-3262		6 DOZ.
CHI-3264	BREAD/BUTTER PLATE	6" DIA.	6 DOZ.
CHI-3265	SALAD PLATE	8.25" DIA.	6 DOZ.
CHI-3266	DINNER PLATE	10.75" DIA.	2 DOZ.
CHI-3267	SOUP BOWL	9 OZ., 8" DIA.	6 DOZ.
CHI-3268	CHOP PLATE	12" DIA.	18 EA.
CHI-3271	SUGAR BOWL WITH COVER		3 DOZ.
CHI-3272	CREAMER	9 OZ.	3 DOZ.



WHITE RIMMED CHINA  
PLAIN WHITE RIMMED CHINA. SOLD IN CASE PACKS ONLY!

			CASE PACK
CHI-3220	SHORT STACKING CUP	8 OZ.	6 DOZ.
CHI-3221	SAUCER, FITS CUP CHI-3220		6 DOZ.
CHI-3222	FOOTED TEA CUP,	8 OZ.	6 DOZ.
CHI-3223	SAUCER, FITS CUP CHI-3222		6 DOZ.
CHI-3224	BREAD/BUTTER PLATE	6" DIA.	6 DOZ.
CHI-3225	SALAD PLATE	8" DIA.	6 DOZ.
CHI-3226	DINNER PLATE	10.25" DIA.	2 DOZ.
CHI-3227	RIM SOUP W/SAUCER	9 OZ., 8" DIA.	4 DOZ.
CHI-3228	LUNCHEON PLATE	9" DIA.	6 DOZ.
CHI-3229	PLATE	12" DIA.	18 EA.
CHI-3230	FRUIT CUP	9 OZ., 5.5" DIA.	3 DOZ.
CHI-3231	SUGAR BOWL W/ COVER	10 OZ.	3 DOZ.
CHI-3232	CREAMER	9 OZ.	3 DOZ.
CHI-3233	RIM SOUP	10 OZ., 9" DIA.	3 DOZ.
CHI-3235	DEMITASSE CUP	3.5 OZ.	24 DOZ.
CHI-3237	RIM SOUP	9 OZ., 8" DIA.	6 DOZ.
CHI-3238	SAUCER FOR DEMI CUP		24 DOZ.
CHI-32381	SOUP TUREEN	40 OZ., 9"	18 EA.
CHI-32382	SOUP TUREEN	3 QT., 10"	8 EA.
CHI-32383	MUG	10 OZ.	4 DOZ.



WHITE (PORCELAIN)

			CASE PACK
CHI-75001	DINNER PLATE	10.75" DIA.	1 DOZ.
CHI-75002	RIM SOUP PLATE	8" DIA.	1 DOZ.
CHI-75003	SALAD PLATE	7.5" DIA.	1 DOZ.
CHI-75004	CAN CUP AND SAUCER		1 DOZ.
CHI-75005	BREAD & BUTTER PLATE	6" DIA.	1 DOZ.
CHI-75006	CHARGER	12" DIA.	1 DOZ.
CHI-75007	LUNCH PLATE	9" DIA.	1 DOZ.



BOWL

RECTANGULAR DISH



SQUARE BOWL

SQUARE TRAY

ASIAN TASTING DISHES (CERAMIC)

			CASE PACK
CHI-3101	BOWL	2.5" DIA.	2 DOZ.
CHI-3102	RECTANGULAR DISH	4" x 2.25"	2 DOZ.
CHI-3103	SQUARE BOWL	2.25" x 2.25"	2 DOZ.
CHI-3104	RECTANGULAR TRAY	8" x 2.25"	1 DOZ.
CHI-3105	RECTANGULAR TRAY	7" x 5"	1 DOZ.
CHI-3106	SQUARE TRAY	5" x 5"	1 DOZ.



QUEENSQUARE PLATE  
FINE BONE WHITE CHINA.

			CASE PACK
CHI-46500	SQUARE PLATE	8.25" SQ.	2 DOZ.
CHI-46501	SQUARE PLATE	10.25" SQ.	1 DOZ.
CHI-46502	SQUARE PLATE	12.25" SQ.	1 DOZ.
CHI-46503	RECTANGULAR PLATE	10" x 6.25"	2 DOZ.
CHI-46504	RECTANGULAR PLATE	12" x 7 5/8"	1 DOZ.
CHI-46505	RECTANGULAR PLATE	14" x 8 5/8"	1 DOZ.

# DINNERWARE



CHI-2355 PLATTER

CHI-2368 SAUCER

CHI-2362 FRUIT DISH

CHI-2367 MUG

### RHAPSODY COLLECTION (PORCELAIN)

Item	Item	Item	Item	Case Pack
CHI-2360 PASTA BOWL	CHI-2350 PLATE	6 1/2" DIA.	3 DOZ.	
CHI-2360 BOUILLON BOWL	CHI-2351 PLATE	8 5/8" DIA.	2 DOZ.	
CHI-2370 CREAMER	CHI-2352 PLATE	10 1/2" DIA.	1 DOZ.	
CHI-2371 SUGAR PACKET HOLDER	CHI-2353 PLATE	12 1/2" DIA.	1 DOZ.	
CHI-2372 SUGAR BOWL WITH LID	CHI-2354 PLATTER	10" x 5 3/4" x 1 1/4"	1 DOZ.	
	CHI-2355 PLATTER	12" x 7" x 1 1/4"	1 DOZ.	
	CHI-2356 PLATTER	14" x 8 3/16" x 1 3/8"	1 DOZ.	
	CHI-2357 GRAPEFRUIT BOWL	9 OZ., 6 1/2" DIA.	2 DOZ.	
	CHI-2358 BOWL	21 OZ., 8" DIA. x 2 3/8" H.	2 DOZ.	
	CHI-2359 BOWL	54 OZ., 10" DIA. x 3 1/8" H.	1 DOZ.	
	CHI-2360 PASTA BOWL	29 OZ., 10" DIA. x 2 1/8" H.	1 DOZ.	
	CHI-2361 PASTA BOWL	46 OZ., 12" DIA. x 2 1/4" H.	1 DOZ.	
	CHI-2362 FRUIT DISH	5.5 OZ., 4 1/2" DIA. x 1 3/4" H.	3 DOZ.	
	CHI-2363 BOUILLON BOWL	7 OZ., 3 3/4" DIA. x 2 1/2" H.	3 DOZ.	
	CHI-2364 SALT & PEPPER SET	2 1/4" DIA. x 2 1/2" H.	1 DOZ.	
	CHI-2365 STACKING CUP	8.5 OZ., 3" DIA. x 3 1/8" H.	3 DOZ.	
	CHI-2366 AD CUP	3.5 OZ., 2 7/16" DIA. x 2 3/8" H.	3 DOZ.	
	CHI-2367 MUG	10 OZ., 3 1/8" DIA. x 3 5/16" H.	2 DOZ.	
	CHI-2368 SAUCER	6" DIA.	3 DOZ.	
	CHI-2369 SAUCER	4 3/4" DIA.	3 DOZ.	
	CHI-2370 CREAMER	4 OZ., 4 1/8" DIA. x 2 7/8" H.	1 DOZ.	
	CHI-2371 SUGAR PACKET HOLDER	3 1/4" x 2 3/4" x 2 1/4" H.	1 DOZ.	
	CHI-2372 SUGAR BOWL WITH LID	8 OZ., 4 1/8" DIA. x 3 5/8" H.	1 DOZ.	



CHI-22557 STACKING CUP

CHI-22559 AD CUP

CHI-22562 CREAMER

CHI-22568 SALT & PEPPER SHAKER

### DRESDEN CHINA COLLECTION (PORCELAIN)

SOLD IN CASE PACKS OF DOZEN ONLY.

Item	Item	Item	Case Pack
CHI-22550 PLATE	6 1/4" DIA.	3 DOZ.	
CHI-22551 PLATE	8 3/8" DIA.	2 DOZ.	
CHI-22552 PLATE	10 3/8" DIA.	2 DOZ.	
CHI-22553 PLATE	11 3/4" DIA.	1 DOZ.	
CHI-22554 PLATTER	10 1/8" x 7"	1 DOZ.	
CHI-22555 PLATTER	12 1/8" x 8 1/2"	1 DOZ.	
CHI-22556 PLATTER	14 1/2 x 9 7/8"	1 DOZ.	
CHI-22557 STACKING CUP	9 OZ., 3 3/8" DIA. x 2 1/2" H.	3 DOZ.	
CHI-22558 SAUCER FOR CHI-22557	6 1/2" DIA.	3 DOZ.	
CHI-22559 AD CUP	4 OZ., 2 3/4" DIA. x 1 7/8" H.	3 DOZ.	
CHI-22560 SAUCER FOR CHI-22559	4 3/4" DIA.	3 DOZ.	
CHI-22561 SUGAR PACKET HOLDER	3 3/8" x 2 2/8"	3 DOZ.	
CHI-22562 CREAMER	4 5/8" DIA. x 3" H.	1 DOZ.	
CHI-22563 NAPPIE/OATMEAL BOWL	18 OZ., 5 1/2" DIA. x 2 1/4" H.	2 DOZ.	
CHI-22564 FRUIT BOWL	12 OZ., 4 3/8" DIA. x 2 1/8" H.	3 DOZ.	
CHI-22565 GRAPEFRUIT BOWL	10.5 OZ., 7" DIA. x 2 1/4" H.	2 DOZ.	
CHI-22566 DEEP RIM SOUP BOWL	10 OZ., 8 3/4" x 1 3/8" H.	2 DOZ.	
CHI-22567 DEEP RIM SOUP BOWL	10 OZ., 8 3/4" x 1 3/8" H.	2 DOZ.	
CHI-22568 SALT & PEPPER SHAKERS SET	2" DIA. x 2 5/8" H.	1 DOZ.	

### SLOPE DINNERWARE

THE BRIGHT WHITE COLOR AND SQUARE PROFILE WILL SERVE AS A PERFECT CANVAS FOR ANY CREATION AT YOUR EVENT. ITEMS ARE SOLD IN THE CASE PACKS ONLY. LIMITED ONE YEAR NO CHIP WARRANTY.



Item	Item	Case Pack
CHI-55100	5" SQUARE PLATE	3 DOZ.
CHI-55101	6" SQUARE PLATE	3 DOZ.
CHI-55102	7" SQUARE PLATE	3 DOZ.
CHI-55103	8" SQUARE PLATE	2 DOZ.
CHI-55104	9" SQUARE PLATE	1 DOZ.
CHI-55105	10" SQUARE PLATE	1 DOZ.
CHI-55106	11 1/4" SQUARE PLATE	1 DOZ.
CHI-55107	12" SQUARE PLATE	1 DOZ.
CHI-55108	6 OZ., 3 1/2" SQUARE BOWL	3 DOZ.
CHI-55109	16 OZ., 6" SQUARE BOWL	2 DOZ.
CHI-55110	42 OZ., 8" SQUARE BOWL	1 DOZ.
CHI-55111	10" X 5 1/4" RECTANGULAR PLATTER	1 DOZ.
CHI-55112	11 1/2" X 6 1/2" RECTANGULAR PLATTER	1 DOZ.
CHI-55113	13 1/8" X 7" RECTANGULAR PLATTER	3 DOZ.
CHI-55114	14 1/2" X 8 1/4" RECTANGULAR PLATTER	1 DOZ.
CHI-55115	8 OZ. TALL CUP	3 DOZ.
CHI-55116	6 1/4" WIDE SAUCER FOR TALL CUP	3 DOZ.

### WIDE RIMED BRIGHT WHITE CHINA

SOLD IN CASE PACKS ONLY!



Item	Item	Item	Case Pack
CHI-2327	SQUARE PLATE	3.75" SQ.	6 DOZ.
CHI-2328	SQUARE PLATE	5" SQ.	6 DOZ.
CHI-2329	SQUARE PLATE	6" SQ.	8 DOZ.
CHI-2330	SQUARE PLATE	7" SQ.	6 DOZ.
CHI-2331	SQUARE PLATE	8.5" SQ.	3 DOZ.
CHI-2332	SQUARE PLATE	10" SQ.	18 EACH
CHI-2333	SQUARE PLATE	12" SQ.	1 DOZ.
CHI-2334	TRIANGLE PLATE	8" SIDE	6 DOZ.
CHI-2335	TRIANGLE PLATE	10" SIDE	4 DOZ.
CHI-2336	TRIANGLE PLATE	12" SIDE	2 DOZ.
CHI-2337	TRIANGLE PLATE	14" SIDE	2 DOZ.
CHI-2338	SQUARE WHITE SAUCER		4 DOZ.
CHI-2338S	7 OZ. WHITE SQUARE CUP		4 DOZ.

# DINNERWARE



**OPAL INNOCENCE CARVED**  
SOLD IN CASE PACKS ONLY!

			
CHI-78514 BOWL	CHI-78518 DEMI CUP	CHI-78521 V SHAPE CUP	
<b>PURE ELEMENTS COUPE</b>			
			
CHI-78519 DEMI SAUCER	CHI-78522 DUAL SAUCER		
			<b>CASE PACK</b>
CHI-78510	PLATE	12" DIA.	1 DOZ.
CHI-78511	PLATE	10" DIA.	2 DOZ.
CHI-78512	PLATE	8" DIA.	2 DOZ.
CHI-78513	COUPE	6" DIA.	3 DOZ.
CHI-78514	BOWL	9" DIA.	2 DOZ.
CHI-78515	OVAL PLATTER	12"	1 DOZ.
CHI-78516	OVAL PLATTER	10"	1 DOZ.
CHI-78517	OVAL PLATTER	8"	2 DOZ.
CHI-78518	V SHAPE DEMI CUP	3 OZ.	2 DOZ.
CHI-78519	DEMI SAUCER	5" DIA.	6 DOZ.
CHI-78520	V SHAPE CUP	8 OZ.	2 DOZ.
CHI-78521	V SHAPE CUP	12 OZ.	2 DOZ.
CHI-78522	DUAL SAUCER	6" DIA.	4 DOZ.

			
CHI-8060 PLATE			
			
CHI-8072 HORS D'OEUVERS TRAY			
CHI-8060	PLATE	11.25"	20 EACH
CHI-8061	PLATE	9"	30 EACH
CHI-8062	PLATE	7.25"	16 EACH
CHI-8063	PLATE	6.5"	56 EACH
CHI-8064	CUP	12 OZ.	68 EACH
CHI-8065	SAUCER	6.5"	68 EACH
CHI-8066	MUG	14 OZ.	20 EACH
CHI-8067	PASTA BOWL	32 OZ.	26 EACH
CHI-8068	ALL PURPOSE BOWL	24 OZ.	38 EACH
CHI-8069	FRUIT BOWL	22 OZ.	48 EACH
CHI-8070	SERVING BOWL	76 OZ.	8 EACH
CHI-8071	SERVING BOWL	96 OZ.	8 EACH
CHI-8072	HORS D'OEUVERS TRAY	12"	12 EACH
CHI-8073	PLATTER	14"	8 EACH
CHI-8074	PLATTER	16"	12 EACH
CHI-8075	SQUARE ACCENT PLATE	9"	6 EACH
CHI-8078	FOOTED CAKE PLATE	11.25"	8 EACH
CHI-8079	FOOTED BOWL	8 OZ.	36 EACH
CHI-8080	RECTANGULAR BAKER	13"	4 EACH
CHI-8081	SQUARE BAKE	8"	12 EACH
CHI-8082	PITCHER	80 OZ.	12 EACH



**SQUARE PORCELAIN DINNERWARE**  
SOLD IN CASE PACK OF DOZEN.

CHI-97000	DINNER PLATE	10" SQ.	1 DOZ.
CHI-97001	DINNER PLATE	7.5" SQ.	1 DOZ.
CHI-97002	BREAD & BUTTER PLATE	6" SQ.	1 DOZ.
CHI-97003	CUP & SAUCER SET		1 DOZ.

		
CHI-8074 PLATTER	CHI-8075 SQUARE ACCENT PLATE	CHI-8065 SAUCER
		
CHI-8067 PASTA BOWL	CHI-8066 MUG	CHI-8064 CUP
		
CHI-8080 RECTANGULAR BAKER	CHI-8079 FOOTED BOWL	CHI-8082 PITCHER

# DINNERWARE ACCESSORIES



### TASTING AND SAMPLER ACCESSORIES (BRIGHT WHITE PORCELAIN)

THESE TASTING AND SAMPLERS ARE A GREAT WAY TO DISPLAY APPETIZERS, SAMPLE BITES, AND TAPPAS. THE BRIGHT WHITE COLOR WILL SURELY LET YOUR FOOD POP RIGHT OFF THE TABLE!

Product Code	Description	Quantity	Case Pack	Product Code	Description	Quantity	Case Pack
CHI-40610	GOLD FISH SAMPLING SPOON	0.25 OZ., 3 3/4"	3 DOZ.	CHI-40638	3-COMPARTMENT DISH	4 OZ WELLS, 8 3/4" x 4 1/4"	2 DOZ.
CHI-40611	SAMPLING SPOON	5"	4 DOZ.	CHI-40639	SQUARE TRIPLE SQUARE BOWL	2 OZ WELLS, 9"	3 DOZ.
CHI-40612	CURVED SAMPLING SPOON	0.5 OZ., 4 3/4"	3 DOZ.	CHI-40640	SQUARE TRIPLE SQUARE BOWL	5 OZ WELLS, 12"	2 DOZ.
CHI-40613	SQUARE SAMPLING SPOON	0.75 OZ., 5 1/8"	3 DOZ.	CHI-40641	TRIPLE SQUARE BOWL	15" SQ.	1 DOZ.
CHI-40614	SAMPLING BOWL WITH HANDLE	1.75 OZ., 3 1/2" x 2 3/4"	2 DOZ.	CHI-40642	SQUARE BOWL	14.5 OZ., 4 1/2" W. x 2 1/4" H.	3 DOZ.
CHI-40615	SAMPLING BOWL WITH CURVED HANDLE	2 OZ., 4 3/4" x 2 1/2"	2 DOZ.	CHI-40643	SQUARE BOWL	23 OZ., 5 1/8" x 3 1/4" H.	2 DOZ.
CHI-40616	SAMPLING TEARDROP BOWL	1.5 OZ., 4" x 3"	2 DOZ.	CHI-40644	SQUARE DISH	7 OZ., 4 1/2" x 1 1/2" H.	3 DOZ.
CHI-40617	ROUND SAMPLING BOWL WITH HANDLE	3.5 OZ., 4 7/8" x 3 1/8"	2 DOZ.	CHI-40645	STACKABLE BOWL	10 OZ., 4 1/2" D. x 2 1/8" H.	3 DOZ.
CHI-40618	SAMPLING SKILLET BOWL WITH HANDLE	2 OZ., 4 3/4" x 3 5/8"	3 DOZ.	CHI-40646	STACKABLE BOWL	124 OZ., 6" D. x 2 3/8" H.	3 DOZ.
CHI-40619	SAMPLING DEEP BOWL WITH HANDLE	4 OZ., 4 3/8" x 3 3/8"	2 DOZ.	CHI-40647	STACKABLE BOWL	136 OZ., 7" D. x 2 1/2" H.	2 DOZ.
CHI-40620	SAMPLING BOWL WITH SMALL HANDLE	3 OZ., 4 3/4" x 3 1/4"	2 DOZ.	CHI-40648	STACKABLE BOWL	64 OZ., 9" D. x 2 5/8" H.	1 DOZ.
CHI-40621	RECTANGULAR DISH TRAY	13 1/2" x 4 3/4"	3 DOZ.	CHI-40649	CONE SHAPED BOWL	7 OZ., 3 1/4" D. x 5 1/4" H.	1 DOZ.
CHI-40622	SAUCE PLATE	5 1/2" x 2 3/4"	3 DOZ.	CHI-40650	CONE SHAPED BOWL	13 OZ., 3 3/4" D. x 6" H.	1 DOZ.
CHI-40623	SAUCE PLATE	7" x 3"	3 DOZ.	CHI-40651	MINI FLORAL POT BOW	6 OZ., 3 1/5" D. x 2 3/4" H.	1 DOZ.
CHI-40624	SMALL SAUCE DISH	2 OZ., 3 3/4" x 2 1/2" x 1" H.	4 DOZ.	CHI-40652	TRIANGULA BOWL	8 OZ., 8 1/5" D. x 2" H.	1 DOZ.
CHI-40625	SAMPLING BOWL	1.75 OZ., 3 5/8" x 2 3/4"	3 DOZ.	CHI-40653	CRESCENT DISH	3 OZ., 6" D. x 3/4" H.	1 DOZ.
CHI-40626	SAMPLING BOWL	1.75 OZ., 3" x 3"	3 DOZ.	CHI-40654	CRESCEN DISH	8.75 OZ., 8" D. x 1" H.	1 DOZ.
CHI-40627	SAMPLING BOWL	1.75 OZ., 4 3/8" x 3 3/8"	3 DOZ.	CHI-40655	CRESCEN DISH	14.25 OZ., 9" D. x 1 1/8" H.	1 DOZ.
CHI-40628	SAMPLING BOWL	2 OZ., 3"	3 DOZ.	CHI-40656	SLANTED SIDE BOWL	4 OZ., 4" D. x 1 3/4" H.	3 DOZ.
CHI-40629	SAMPLING BOWL	9 OZ., 5"	1 DOZ.	CHI-40657	SLANTED SIDE BOWL	6 OZ., 5" D. x 2 3/8" H.	3 DOZ.
CHI-40630	ROUND SAMPLING DISH WITH HANDLES	4 OZ., 5 1/4" x 1 1/16" H.	1 DOZ.	CHI-40658	SLANTED SIDE BOWL	10.5 OZ., 7" D. x 3 3/8" H.	2 DOZ.
CHI-40631	RECTANGULAR SCOOPED BOWL	3.5 OZ., 3 3/4" x 2 3/4" x 1 1/2" H.	2 DOZ.	CHI-40659	SLANTED SIDE BOWL	20 OZ., 8 1/2" D. x 4" H.	1 DOZ.
CHI-40632	FOUR DIVIDED BOWL	1.5 OZ., 4 1/2" DIA. x 2 3/4" H.	1 DOZ.	CHI-40660	SLANTED SIDE BOWL	35 OZ., 10" D. x 4 1/2" H.	6 EACH
CHI-40633	FOUR DIVIDED BOWL	2 OZ., 5" DIA. x 1 1/2" H.	1 DOZ.	CHI-40661	TULIP BOWL	16 OZ., 6 1/2" D. x 2 3/8" H.	2 DOZ.
CHI-40634	FOUR DIVIDED BOWL	7 OZ., 6 1/2" DIA. x 4 1/2" H.	1 DOZ.	CHI-40662	TULIP BOWL	40 OZ., 8" D. x 3" H.	1 DOZ.
CHI-40635	2-COMPARTMENT SAUCE DISH	3" x 3/4" H.	4 DOZ.	CHI-40663	TULIP BOWL	60 OZ., 9 5/8" D. x 3 3/8" H.	1 DOZ.
CHI-40636	2-COMPARTMENT SAUCE DISH	5" x 3/4" H.	3 DOZ.	CHI-40664	BOWL WITH LID	24 OZ., 7 3/8" D. x 3 1/2" H.	1 DOZ.
CHI-40637	3-COMPARTMENT DISH	1 OZ. WELLS, 5 3/4" x 2 3/8"	3 DOZ.	CHI-40665	UNITY PLATE	7 OZ INNER WELL, 12", 9.5 OZ. OUTER WELLS	2 DOZ.
				CHI-40666	UNITY PLATE	9.5 OZ INNER WELL, 14", 15 OZ. OUTER WELLS	1 DOZ.



# DINNERWARE



### PRISTINE

A SIMPLE AND UNDERSTATED DESIGN, PRISTINE IS AN UNDECORATED WHITE CHINA COLLECTION THAT WORKS WELL IN VIRTUALLY ANY ENVIRONMENT. AN EXCELLENT CHOICE FOR RESTAURANTS AND CATERERS.

CHI-6000069	SMALL SQUARE TRAY		CASE PACK
CHI-60000630	STACKING BOUILLON	7 OZ.	3 DOZ.
CHI-60000633	PLATE	5 3/8" DIA.	3 DOZ.
CHI-60000634	PLATE	6 3/8" DIA.	3 DOZ.
CHI-60000635	PLATE	7 3/8" DIA.	3 DOZ.
CHI-60000636	PLATE	8 3/8" DIA.	3 DOZ.
CHI-60000637	PLATE	9" DIA.	2 DOZ.
CHI-60000638	PLATE	9 5/8" DIA.	2 DOZ.
CHI-60000639	PLATE	10 5/8" DIA.	1 DOZ.
CHI-60000640	PLATE	11 1/8" DIA.	1 DOZ.
CHI-60000642	PLATE	12 1/4" DIA.	1 DOZ.
CHI-60000643	PASTA BOWL	11 1/8" DIA.	1 DOZ.
CHI-60000644	GRAPEFRUIT COUP	6 1/8" DIA.	3 DOZ.
CHI-60000645	RIM SOUP BOWL	9" DIA.	2 DOZ.
CHI-60000647	FRUIT COUPE	5 OZ.	3 DOZ.
CHI-60000648	OVAL PLATTER	11 5/8"	1 DOZ.
CHI-60000649	NAPPY BOWL	13 OZ.	3 DOZ.
CHI-60000650	OVAL PLATTER	13 1/2"	1 DOZ.
CHI-60000651	SOUP BOWL, 2 HANDLES	9 OZ.	3 DOZ.
CHI-60000653	STACKING TEACUP	7 OZ.	3 DOZ.
CHI-60000654	TALL TEACUP	8 OZ.	3 DOZ.
CHI-60000655	SAUCER	5 3/4" DIA.	3 DOZ.
CHI-60000656	A.D. CUP	5 OZ.	1 DOZ.
CHI-60000657	A.D. SAUCER		1 DOZ.
CHI-60000658	SAUCE BOAT	10 OZ.	1 DOZ.
CHI-60000659	CREAMER	4 OZ.	1 DOZ.
CHI-60000660	CREAMER	7 OZ.	1 DOZ.
CHI-60000661	SUGAR PACKET HOLDER		1 DOZ.
CHI-60000663	SALT SHAKER	2 3/8" H.	1 DOZ.
CHI-60000665	PEPPER SHAKE	2 3/8" H.	1 DOZ.
CHI-60000666	TEAPOT	17 OZ.	1 DOZ.
CHI-60000671	MUG	9 OZ.	3 DOZ.
CHI-60000672	SMALL CRESCENT SALAD PLATE		1 DOZ.
CHI-60000673	ELEGANT TEACUP	8 OZ.	1 DOZ.
CHI-60000674	PLATE	10 1/4" DIA.	1 DOZ.
CHI-60000675	PLATE	11 3/4" DIA.	1 DOZ.
CHI-60000679	MEDITERRANEAN PASTA BOWL		1 DOZ.
CHI-60000689	RECTANGULAR APPETIZER TRAY		1 DOZ.



SALAD BOWL	CHI-5244	SALAD BOWL	8 OZ., 6" x 3"	CASE PACK
	CHI-5245	SALAD BOWL	12 OZ., 7 1/4" x 3 1/4"	3 DOZ.
	CHI-5246	SALAD BOWL	20 OZ., 8" x 3 1/2"	2 DOZ.
	CHI-5247	SALAD BOWL	26 OZ., 9" x 3 3/4"	1 DOZ.
	CHI-5248	SALAD BOWL	36 OZ., 10" x 4 3/8"	1 DOZ.
	CHI-5249	PLATE	12" x 3"	1 DOZ.
	CHI-5250	SPIRIT DISH	6" x 4" x 1/4"	2 DOZ.
	CHI-5251	SPIRIT DISH	7 1/2" x 4 1/2" x 3 1/4"	2 DOZ.
	CHI-5252	SPIRIT DISH	8 1/2" x 5" x 4"	2 DOZ.
	CHI-5253	SPIRIT DISH	11" x 7" x 5"	1 DOZ.
	CHI-5352	CUP	7.5 OZ., 3 1/2" x 3 1/2" H.	3 DOZ.
	CHI-5353	SAUCER	6" x 1 1/2"	3 DOZ.
	CHI-5354	A.D. CUP	3.5 OZ., 2 1/2" x 2" H.	3 DOZ.
	CHI-5355	A.D. SAUCER	4 1/2" x 1 1/2"	3 DOZ.
	CHI-53555	SALAD BOWL	8 OZ., 5" x 3"	3 DOZ.
	CHI-53556	PLATE	8" x 1 1/2"	3 DOZ.
	CHI-53557	PLATE	10" x 2 1/2"	1 DOZ.
	CHI-53558	SALT SHAKER	1 3/4" x 4 1/4"	4 DOZ.
	CHI-53559	PEPPER SHAKER	1 3/4" x 4 1/4"	4 DOZ.

WHITE SERVING PLATTERS & BOWLS (PORCELAIN)	CHI-36000	20" DIA. ROUND PLATTER	CASE PACK
	CHI-36001	18" DIA. ROUND PLATTER	SET/4
	CHI-36002	16" DIA. ROUND PLATTER	SET/6
	CHI-36003	14" DIA. ROUND PLATTER	SET/8
	CHI-36004	12" DIA. ROUND PLATTER	SET/12
	CHI-36009	22" x 15.25" OVAL PLATTER	SET/24
	CHI-36010	20" x 14" OVAL PLATTER	SET/6
	CHI-36011	18" x 13" OVAL PLATTER	SET/9
	CHI-36012	16" x 11" OVAL PLATTER	SET/12
	CHI-36013	14" x 11" OVAL PLATTER	SET/24
	CHI-36014	12" x 9" OVAL PLATTER	SET/36
	CHI-36015	20" x 13.5" RECTANGULAR PLATTER	SET/6
	CHI-36016	18" x 12" RECTANGULAR PLATTER	SET/8
	CHI-36017	16" x 10.5" RECTANGULAR PLATTER	SET/12
	CHI-36018	15.75" x 9.75" RECTANGULAR PLATTER	SET/12
	CHI-36019	13.75" x 8" RECTANGULAR PLATTER	SET/18
	CHI-36024	25.5" x 8.75" OVAL PLATTER	SET/6
	CHI-36015	20" x 13.5" RECTANGULAR PLATTER	SET/6
	CHI-36016	18" x 12" RECTANGULAR PLATTER	SET/8
	CHI-36017	16" x 19.5" RECTANGULAR PLATTER	SET/12
	CHI-36018	15.75" x 9.75" RECTANGULAR PLATTER	SET/12
	CHI-36019	13.75" x 8" RECTANGULAR PLATTER	SET/18
	CHI-36020	12" x 6" RECTANGULAR PLATTER	SET/36
	CHI-36021	11.75" x 7" RECTANGULAR PLATTER	SET/24
	CHI-36022	17" x 8.25" RECTANGULAR PLATTER	SET/12
	CHI-36023	12" x 5" CURVED RECTANGULAR PLATTER	SET/48
	BWL-36101	16" DIA. BOWL	SET/4
	BWL-36102	14" DIA. BOWL	SET/5
	BWL-36103	12" DIA. BOWL	SET/8
	BWL-36104	9" DIA. BOWL	SET/18
	BWL-36105	6" DIA. BOWL	SET/72
	BWL-36106	4.5" DIA. BOWL	SET/120



### DURASAN SQUARE (PORCELAIN)

CHI-2821	DINNER PLATE	10.5" SQ.	CASE PACK
CHI-2822	SALAD PLATE	7.5"	2 DOZ.
CHI-2823	BREAD & BUTTER PLATTER	6.5" DIA	2 DOZ.
CHI-2824	CUP & SAUCER	3.5" CUP, 5.5" DIA. SAUCER	2 DOZ.
CHI-2825	PLATE	12" SQ.	2 DOZ.
CHI-2826	BOWL	8"	2 DOZ.

DINNERWARE (PORCELAIN)	CHI-369482	DINNER PLATE	10.5" DIA.	CASE PACK
	CHI-369483	SALAD PLATE	7.5" DIA.	2 DOZ.
	CHI-369484	BREAD/BUTTER PLATE	6.5" DIA.	2 DOZ.
	CHI-369485	CUP AND SAUCER SET		2 DOZ.
	CHI-369486	LUNCH PLATE	9" DIA.	2 DOZ.
	CHI-369487	ROUND PLATTER	12" DIA.	16 EACH
	CHI-369488	SOUP/CEREAL	8" DIA.	2 DOZ.

# DINNERWARE



WHITE RIM WITH GOLD BAND DINNERWARE

Item #	Description	Size	Case Pack
CHI-31150	RM PLATE	12"	1 DOZ.
CHI-31152A	RIM PLATE	10 1/2"	2 DOZ.
CHI-31153	RIM PLATE	9 1/8"	2 DOZ.
CHI-31154	RIM PLATE	8 1/4"	2 DOZ.
CHI-31155	RIM PLATE	7 3/4"	2 DOZ.
CHI-31156	RIM PLATE	6 1/2"	2 DOZ.
CHI-31157	CAN CUP		2 DOZ.
CHI-31158	CAN SAUCER		2 DOZ.
CHI-31159	FOOTED CUP		2 DOZ.
CHI-31160	FOOTED SAUCER		2 DOZ.
CHI-31161	RIM SOUP	8 1/2"	2 DOZ.
CHI-31162	CREAM SOUP		2 DOZ.
CHI-31163	CREAM SOUP SAUCER		2 DOZ.
CHI-31164	BOUILLON, NO HANDLE		2 DOZ.
CHI-31165	SALAD BOWL	9"	2 DOZ.
CHI-31166	OVAL RIM PLATE	14" OVAL	1 DOZ.
CHI-31168	A.D. CUP		2 DOZ.
CHI-31169	A.D. SAUCER		2 DOZ.
CHI-31170	SUGAR WITH LID		2 DOZ.
CHI-31171	CREAMER		2 DOZ.



WHITE WITH PLATINUM BAND DINNERWARE

Item #	Description	Size	Case Pack
CHI-41150	RIM PLATE	12"	1 DOZ.
CHI-41152A	RIM PLATE	10 1/2"	2 DOZ.
CHI-41153	RIM PLATE	9 1/8"	2 DOZ.
CHI-41154	RIM PLATE	8 1/4"	2 DOZ.
CHI-41155	RIM PLATE	7 3/4"	2 DOZ.
CHI-41156	RIM PLATE	6 1/2"	2 DOZ.
CHI-41157	CAN CUP		2 DOZ.
CHI-41158	CAN SAUCER		2 DOZ.
CHI-41159	FOOTED CUP		2 DOZ.
CHI-41160	FOOTED SAUCER		2 DOZ.
CHI-41161	RIM SOUP	8 1/2"	2 DOZ.
CHI-41162	CREAM SOUP		2 DOZ.
CHI-41163	CREAM SOUP SAUCER		2 DOZ.
CHI-41164	BOUILLON, NO HANDLE		2 DOZ.
CHI-41165	SALAD BOWL	9"	2 DOZ.
CHI-41166	OVAL RIM PLATE	14" OVAL	1 DOZ.
CHI-41168	A.D. CUP		2 DOZ.
CHI-41169	A.D. SAUCER		2 DOZ.
CHI-41170	SUGAR WITH LID		2 DOZ.
CHI-41171	CREAMER		2 DOZ.



WHITE RIM UNDECORATED

Item #	Description	Size	Case Pack
CHI-21150	ROUND RIM PLATE	12"	1 DOZ.
CHI-21152A	ROUND RIM PLATE	10 1/4"	2 DOZ.
CHI-21153	ROUND RIM PLATE	9 1/8"	2 DOZ.
CHI-21155	ROUND RIM PLATE	7 3/4"	2 DOZ.
CHI-21156	ROUND RIM PLATE	6 1/2"	2 DOZ.
CHI-21157	BARREL CUP		2 DOZ.
CHI-21158	BARREL SAUCER		2 DOZ.
CHI-21159	FOOTED CUP	3 1/4" TALL, 4 1/2" WIDE	2 DOZ.
CHI-21160	FOOTED SAUCER FOR FOOTED CUP 6"		2 DOZ.
CHI-21162	CREAM SOUP		2 DOZ.
CHI-21164	BOUILLON, NO HANDLE		2 DOZ.
CHI-21165	SALAD BOWL	9"	2 DOZ.
CHI-21166	OVAL RIM PLATE	14" OVAL	1 DOZ.
CHI-21167	PASTA BOWL	12"	1 DOZ.
CHI-21168	A.D. CUP		2 DOZ.
CHI-21169	A.D. SAUCER		2 DOZ.
CHI-21170	SUGAR WITH LID		2 DOZ.
CHI-21171	CREAMER		2 DOZ.



BLACK SQUARE (PORCELAIN)  
SOLD IN CASE PACKS ONLY!

Item #	Description	Size	Case Pack
CHI-1260	RIM PLATE	10 3/4"	2 DOZ.
CHI-1261	RIM PLATE	8 1/4"	2 DOZ.
CHI-1262	RIM PLATE	7"	2 DOZ.
CHI-1263	BARREL CUP		2 DOZ.
CHI-1264	BARREL SAUCER		2 DOZ.
CHI-1265	RIM SOUP	8 1/2"	2 DOZ.



EGG DISHES (WHITE PORCELAIN)

SOLD IN CASE PACKS ONLY!

Item #	Description	Size	Case Pack
CHI-5328		6 1/2"	3 DOZ.
CHI-5329		7 1/4"	3 DOZ.
CHI-5330		8"	3 DOZ.



WHITE SQUARE (PORCELAIN)  
SOLD IN CASE PACKS ONLY!

Item #	Description	Size	Case Pack
CHI-1250	RIM PLATE	10 3/4"	2 DOZ.
CHI-1251	RIM PLATE	8 1/4"	2 DOZ.
CHI-1252	RIM PLATE	7"	2 DOZ.
CHI-1253	BARREL CUP		2 DOZ.
CHI-1254	BARREL SAUCER		2 DOZ.
CHI-1255	RIM SOUP	8 1/2"	2 DOZ.



WAVY SQUARE BOWLS (PORCELAIN)

WAVY SQUARE BOWL WILL INSTILL A SENSE OF FUN AND CREATIVITY TO YOUR FOOD PRESENTATIONS.

Item #	Description	Size	Case Pack
CHI-13924		5.5" DIA.	3" H.
CHI-13925		8.5" DIA.	3.75" H.
CHI-13926		10.5" DIA.	4 3/8" H.
CHI-13927		12" DIA.	4 7/8" H.

# DINNERWARE



### HAKONE

HAKONE HAS A BEAUTIFUL BROWN AND BLUE COLORING THAT WILL ADD CLASS TO YOUR EVENT. SOLD IN CASE PACKS ONLY.

			CASE PACK
CHI-7770	SQUARE PLATE	6 1/4" SQ.	3 DOZ.
CHI-7771	SQUARE PLATE	10 1/2" SQ.	1 DOZ.
CHI-7772	RECTANGULAR PLATTER	11 1/2" X 5"	1 DOZ.
CHI-7773	MUG	14 OZ.	1 DOZ.
CHI-7774	BOWL	31 OZ.	1 DOZ.



### BRIGHT WHITE WITH GOLD BAND

SOLD IN THE CASE PACKS ONLY.  
MANUFACTURE'S 3 YEAR NO CHIP WARRANTY.

			CASE PACK
CHI-25750	PLATE	6" DIA.	8 DOZ.
CHI-25751	PLATE	8" DIA.	3 DOZ.
CHI-25752	PLATE	10.5" DIA.	1 DOZ.
CHI-25753	PLATE	12" DIA.	1 DOZ.
CHI-25754	SOUP/PASTA PLATE	9.25" DIA.	2 DOZ.
CHI-25755	CUP	8.5 OZ.	4 DOZ.
CHI-25756	SAUCER	6" DIA.	8 DOZ.



### BRIGHT WHITE WITH PLATINUM BAND

SOLD IN THE CASE PACK ONLY.  
MANUFACTURE'S 3 YEAR NO CHIP WARRANTY.

			CASE PACK
CHI-25760	PLATE	6" DIA.	8 DOZ.
CHI-25761	PLATE	8" DIA.	3 DOZ.
CHI-25762	PLATE	10.5" DIA.	1 DOZ.
CHI-25763	PLATE	12" DIA.	1 DOZ.
CHI-25764	SOUP/PASTA PLATE	9.25" DIA.	2 DOZ.
CHI-25765	CUP	8.5 OZ.	4 DOZ.
CHI-25766	SAUCER	6" DIA.	8 DOZ.



CHI-323203



CHI-323205

CHI-323206

CHI-323207

CHI-323208

CHI-323211

CHI-323212

CHI-323210

CHI-323213

CHI-323214

### CAMPFIRE COLLECTION (CHINA)

THE CAMPFIRE COLLECTION IS A VIBRANT OCEAN BLUE WITH WHITE SPECKLES. THE COLLECTION HAS MANY CHOICES, INCLUDING ROLLED EDGE OR NARROW RIM PLATES AND PLATTERS. SOLD IN CASE PACKS OF DOZEN.

			CASE PACK
CHI-323200	PLATE	12" DIA.	1 DOZ.
CHI-323201	PLATE	10 1/2" DIA.	1 DOZ.
CHI-323202	PLATE	7 1/8" DIA.	3 DOZ.
CHI-323203	NARROW RIM PLATE	10 1/2" DIA.	1 DOZ.
CHI-323204	NARROW RIM PLATE	7 5/16" DIA.	3 DOZ.
CHI-323205	RIM SOUP BOWL	8 3/4" DIA.	2 DOZ.
CHI-323206	GRAPEFRUIT BOWL	13 OZ., 6 3/8" DIA.	3 DOZ.
CHI-323207	FRUIT BOWL	4.75 OZ., 4 3/4" DIA.	3 DOZ.
CHI-323208	BOUILLON	7.25 OZ.	3 DOZ.
CHI-323209	PLATTER	11 1/2" DIA.	1 DOZ.
CHI-323210	NARROW RIM PLATTER	11 1/2" DIA.	1 DOZ.
CHI-323211	COFFEE MUG	8.5 OZ.	3 DOZ.
CHI-323212	SAUCER	6" DIA.	3 DOZ.
CHI-323213	SUGAR BOWL	14 OZ.	1 DOZ.
CHI-323214	CREAMER	12.5 OZ.	3 DOZ.



### PARIS (IVORY CHINA)

TEXTURED RIMS WITH A LINEAR DESIGN. SOLD IN CASE PACKS ONLY!

			CASE PACK
CHI-81150	CHARGER PLATE	12"	1 DOZ.
CHI-81151	PLATE	11"	2 DOZ.
CHI-81152	RIM PLATE	9.25"	2 DOZ.
CHI-81153	SALAD/DESSERT PLATE	8.5"	2 DOZ.
CHI-81154	BREAD & BUTTER	6.5"	2 DOZ.
CHI-81155	RIM SOUP	9.5"	1 DOZ.
CHI-81156	PASTA BOWL	11"	2 DOZ.
CHI-81157	BOUILLON		2 DOZ.
CHI-81158	CAN CUP		2 DOZ.
CHI-81159	DOUBLE WELL SAUCER		2 DOZ.
CHI-81160	FOOTED CUP		2 DOZ.
CHI-81161	CREAMER		2 DOZ.
CHI-81162	SUGAR		2 DOZ.



PLT-2000

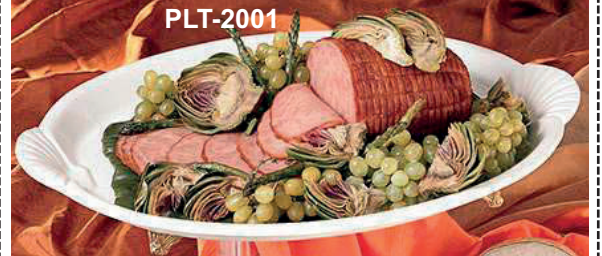

PLT-2001

### SHELL DISPLAY PLATTERS WITH BRASS LEGS

EACH ONE HAS A SHELL DESIGN ON THE HANDLES WITH BRASS LEGS FOR ADDED SUPPORT. GREAT FOR RESTAURANTS AND CATERERS!

			CASE PACK
PLT-2000	PLATTER WITH 6 LEG	22" x 32"	1 DOZ.
PLT-2001	PLATTER WITH 4 LEG	18" x 24.75"	1 DOZ.



### ONION SOUP CROCK

SOLD IN CASE PACKS ONLY!

			CASE PACK
CHI-5286	AMERICAN WHITE WITH HANDLE	15 OZ.	2 DOZ.
CHI-5319	BROWN	12 OZ.	2 DOZ.
CHI-5320	BROWN WITH CREAM BOTTOM	12 OZ.	2 DOZ.
CHI-5321	BROWN WITH HANDLE	15 OZ.	2 DOZ.



CHI-11950

CHI-11951

CHI-11952

CHI-11953

### SOUP CROCK

			CASE PACK
CHI-11950	AMERICAN WHITE	12 OZ., 5.25" DIA.	4 DOZ.
CHI-11951	CARAMEL BROWN	12 OZ., 5.25" DIA.	4 DOZ.
CHI-11952	CARAMEL BROWN/BEIGE	12 OZ., 5.25" DIA.	4 DOZ.
CHI-11953	W/HANDLE, CARAMEL BROWN	12 OZ., 5.25" DIA.	2 DOZ.

# DINNERWARE



The Homer Laughlin China Company®



Made In The USA

**LIMITED LIFETIME NO CHIP WARRANTY**

## FIESTA DINNERWARE

MADE IN THE USA AND COMES WITH A LIMITED LIFETIME WARRANTY AGAINST CHIPPING UNDER NORMAL USAGE CONDITIONS. VARIOUS COLORS ARE AVAILABLE IN COBALT, LEMONGRASS, SCARLET, SHAMROCK, SUNFLOWER, TANGERINE AND TURQUOIS.



### SUNFLOWER



### LEMONGRASS



### COBALT

Item	Description	Case Pack
CHI-118000	11 3/4" DIA. CHOP PLATE	4 EACH
CHI-118001	10 1/2" DIA. DINNER PLATE	1 DOZ.
CHI-118002	9" DIA. LUNCH PLATE	1 DOZ.
CHI-118003	7 1/4" DIA. SALAD PLATE	1 DOZ.
CHI-118004	6 1/8" DIA. BREAD AND BUTTER PLATE	1 DOZ.
CHI-118006	13 5/8" OVAL PLATTER	1 DOZ.
CHI-118007	11 5/8" OVAL PLATTER	1 DOZ.
CHI-118008	9 5/8" OVAL PLATTER	1 DOZ.
CHI-118009	18 OZ. JUMBO CUP	1 DOZ.
CHI-118011	7 3/4 OZ. CUP	1 DOZ.
CHI-118012	5 7/8" DIA. SAUCER FOR CUP	1 DOZ.
CHI-118015	19 OZ., 6 7/8" DIA. BOWL	1 DOZ.
CHI-118018	6 1/4 OZ., 5 3/8" DIA. FRUIT BOWL	1 DOZ.
CHI-118019	11 OZ., 6 1/2" DIA. CEREAL BOWL	1 DOZ.
CHI-118020	6 3/4 OZ., 4" DIA. BOUILLON	1 DOZ.
CHI-118021	18 OZ., 4 5/8" DIA. CHILI BOWL	1 DOZ.
CHI-118022	13 1/4 OZ., 9" DIA. RIM SOUP BOWL	1 DOZ.
CHI-118023	SUGAR BOWL & CREAMER SET WITH TRAY	4 SET
CHI-118024	SUGAR PACKET HOLDER, 3 1/2" x 2 3/4"	1 DOZ.
CHI-118025	67 1/4 OZ. DISC PITCHER	2 EACH



### CROCKS (PORCELAIN)

Item	Description	Dimensions	Case Pack
CHI-12901	THREE TONE BROWN	5 1/4" D. x 2 3/8" H.	4 DOZ.
CHI-12902	AMERICAN WHITE	4 5/8" D. x 1 3/8" H. (7 1/4" D. WITH HANDLE)	2 DOZ.
CHI-12903	SOUP CROCK, BROWN	5 1/4" D. x 2 3/8" H.	4 DOZ.
CHI-12904	BROWN	5 1/4" D. x 2 1/8" H. (7 3/4" D. WITH HANDLE)	2 DOZ.



CHI-25700 PLATE

CHI-25704 SOUP BOWL

CHI-25706 PLATTER



CHI-25779 ESPRESSO CUP

CHI-25780 SAUCER

CHI-25783 CREAMER

### DIAMOND (PORCELAIN)

THE DIAMOND COLLECTION IS BONE WHITE PORCELAIN AND HAS A UNIQUE CRESCENT DEIGN SHAPE WITHIN THE PATTERN. ADD SOME PIZAZZ TO YOUR TABLE SETTING WITH THE DIAMOND COLLECTION. SOLD IN CASE PACKS ONLY.



CHI-25784 SUGAR BOWL



CHI-25785 COFFEE POT

Item	Description	Dimensions	Case Pack
CHI-25770	PLATE	6" DIA.	6 DOZ.
CHI-25771	PLATE	8.5" DIA.	2 DOZ.
CHI-25772	PLATE	10.5" DIA.	2 DOZ.
CHI-25773	PLATE	12.5" DIA.	1 DOZ.
CHI-25774	SOUP BOWL	9" DIA.	2 DOZ.
CHI-25775	SOUP BOWL	10" DIA.	2 DOZ.
CHI-25776	PLATTER	10" OVAL	2 DOZ.
CHI-25777	PLATTER	12" OVAL	2 DOZ.
CHI-25778	PLATTER	14" OVAL	2 DOZ.
CHI-25779	ESPRESSO CUP	3 OZ.	4 DOZ.
CHI-25780	SAUCER FOR ESPRESSO CUP	5.5"	5 DOZ.
CHI-25781	COFFEE/TEA CUP	9 OZ.	4 DOZ.
CHI-25782	SAUCER FOR COFFEE/TEA CUP	6"	4 DOZ.
CHI-25783	CREAMER	5 OZ.	8 DOZ.
CHI-25784	SUGAR BOWL	2 OZ.	6 DOZ.
CHI-25785	COFFEE POT	16 OZ.	18 EACH



CHI-1420334 PLATE

CHI-1420330 BOUILLON



CHI-1420331 CUP

CHI-1420355 SAUCER

CHI-1420356 RIM SOUP

### GOTHIC WESTMINSTER

EMBOSSED DESIGN WITH A GOLD BAND. THE INNER AND OUTER RIM ARE BOTH GOLD BANDED. SOLD IN CASE PACKS ONLY!



CHI-1420341 GRAPEFRUIT BOWL

Item	Description	Dimensions	Case Pack
CHI-1420334	PLATE	6 1/4" DIA.	3 DOZ.
CHI-1420336	PLATE	8 1/8" DIA.	3 DOZ.
CHI-1420339	PLATE	10 5/8" DIA.	1 DOZ.
CHI-1420340	PLATE	11 1/8" DIA.	1 DOZ.
CHI-1420342	PLATE	12 1/2" DIA.	1 DOZ.
CHI-1420330	BOUILLON	7 OZ.	3 DOZ.
CHI-1420331	CUP	7 1/2 OZ.	3 DOZ.
CHI-1420332	STACKING MUG	8 OZ.	3 DOZ.
CHI-1420341	GRAPEFRUIT BOWL	10 1/2 OZ., 7 1/4" DIA.	3 DOZ.
CHI-1420354	FRUIT BOWL	2 OZ., 5" DIA.	3 DOZ.
CHI-1420355	SAUCER	5 5/8" DIA.	3 DOZ.
CHI-1420356	RIM SOUP	10 1/2 OZ., 9" DIA.	2 DOZ.

# DINNERWARE

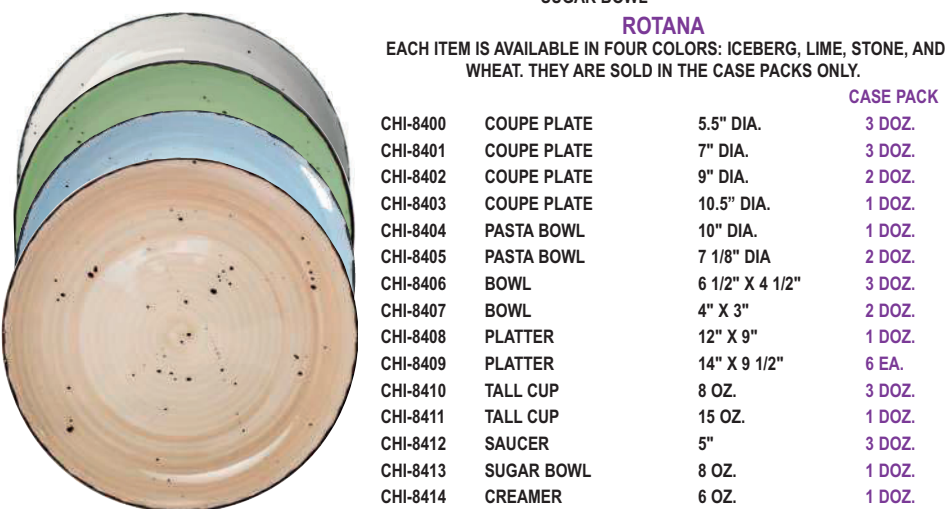

**ROTANA**  
EACH ITEM IS AVAILABLE IN FOUR COLORS: ICEBERG, LIME, STONE, AND WHEAT. THEY ARE SOLD IN THE CASE PACKS ONLY.

Item	Color	Dimensions	Case Pack
CHI-8400	COUPE PLATE	5.5" DIA.	3 DOZ.
CHI-8401	COUPE PLATE	7" DIA.	3 DOZ.
CHI-8402	COUPE PLATE	9" DIA.	2 DOZ.
CHI-8403	COUPE PLATE	10.5" DIA.	1 DOZ.
CHI-8404	PASTA BOWL	10" DIA.	1 DOZ.
CHI-8405	PASTA BOWL	7 1/8" DIA.	2 DOZ.
CHI-8406	BOWL	6 1/2" X 4 1/2"	3 DOZ.
CHI-8407	BOWL	4" X 3"	2 DOZ.
CHI-8408	PLATTER	12" X 9"	1 DOZ.
CHI-8409	PLATTER	14" X 9 1/2"	6 EA.
CHI-8410	TALL CUP	8 OZ.	3 DOZ.
CHI-8411	TALL CUP	15 OZ.	1 DOZ.
CHI-8412	SAUCER	5"	3 DOZ.
CHI-8413	SUGAR BOWL	8 OZ.	1 DOZ.
CHI-8414	CREAMER	6 OZ.	1 DOZ.



CHI-3220, CHI-3221 BARREL TEA CUP WITH SAUCER  
CHI-3222, CHHI-3223 FOOTED TEA CUP WITH SAUCER  
CHI-3224 BREAD/BUTTER PLATE



CHI-3226 DINNER PLATE  
CHI-3227 RIM SOUP WITH SAUCER  
CHI-3231 SUGAR BOWL WITH COVER



CHI-3233 SOUP PLATE  
CHI-3235 DEMITASSE CUP WITH SAUCER  
CHI-3237 SOUP

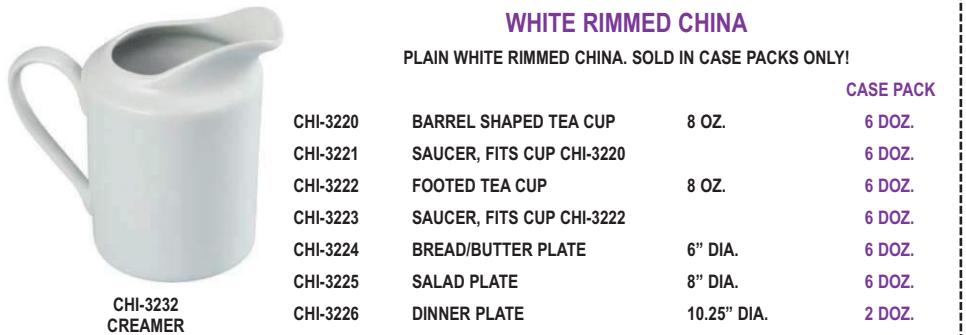

CHI-3232 CREAMER

**WHITE RIMMED CHINA**

PLAIN WHITE RIMMED CHINA. SOLD IN CASE PACKS ONLY!

Item	Color	Dimensions	Case Pack
CHI-3220	BARREL SHAPED TEA CUP	8 OZ.	6 DOZ.
CHI-3221	SAUCER, FITS CUP CHI-3220		6 DOZ.
CHI-3222	FOOTED TEA CUP	8 OZ.	6 DOZ.
CHI-3223	SAUCER, FITS CUP CHI-3222		6 DOZ.
CHI-3224	BREAD/BUTTER PLATE	6" DIA.	6 DOZ.
CHI-3225	SALAD PLATE	8" DIA.	6 DOZ.
CHI-3226	DINNER PLATE	10.25" DIA.	2 DOZ.
CHI-3227	RIM SOUP W/SAUCER	9 OZ., 8"	4 DOZ.
CHI-3228	LUNCHEON PLATE	9" DIA.	6 DOZ.
CHI-3229	PLATE	12" DIA.	18 EA.
CHI-3230	FRUIT BOWL	9 OZ., 5.5" DIA.	3 DOZ.
CHI-3231	SUGAR BOWL W/ COVER	10 OZ.	3 DOZ.
CHI-3232	CREAMER	9 OZ.	3 DOZ.
CHI-3233	SOUP	10 OZ., 9" DIA.	3 DOZ.
CHI-3235	DEMITASSE CUP	3.5 OZ.	24 DOZ.
CHI-3237	SOUP	9 OZ., 8" DIA.	6 DOZ.
CHI-3238	SAUCER FOR DEMI CUP		24 DOZ.

# DINNERWARE



## COUPE, SUPER BRIGHT WHITE (PORCELAIN)

THIS COUPE COLLECTION FEATURES STYLISH SUPER WHITE PORCELAIN PLATES, PLATTERS, AND BOWLS THAT HAVE A SMOOTH CLASSIC DESIGN AND BRIGHTEN ANY TABLE SETTING. THIS PATTERN IS IDEAL FOR RESTAURANTS, CATERERS, WEDDING, HOTELS, AND BANQUET HALLS. DURABLE TO WITHSTAND DAILY USE. OVEN, MICROWAVE, AND DISHWASHER SAFE. BREAK, CHIP, AND SCRATCH RESISTANT.

PRODUCTS ARE SOLD IN CASE PACKS LISTED BELOW ONLY. THIS COUPE COLLECTION OFFERS A ONE YEAR LIMITED EDGE-CHIP WARRANTY FROM THE DATE OF THE PURCHASE ON PLATES AND PLATTERS ONLY.

			CASE PACK
CHI-87500	PLATE	6" DIA. X 1/2" H.	3 DOZ.
CHI-87501	PLATE	7" DIA. X 3/4" H.	3 DOZ.
CHI-87502	PLATE	8" DIA. X 3/4" H.	3 DOZ.
CHI-87503	PLATE	9" DIA. X 1" H.	2 DOZ.
CHI-87504	PLATE	10" DIA. X 1" H.	1 DOZ.
CHI-87505	PLATE	12" DIA. X 1 1/4" H.	1 DOZ.
CHI-87506	PLATE	14" DIA. X 1 3/4" H.	6 EA.
CHI-87507	PLATE	16" DIA. X 2" H.	4 EA.
CHI-87508	OVAL PLATTER	9 1/2" L. X 7 1/4" W. X 1 1/4" H.	2 DOZ.
CHI-87509	OVAL PLATTER	10 1/2" L. X 8 1/4" W. X 1 1/2" H.	2 DOZ.
CHI-87510	OVAL PLATTER	11 1/2" L. X 9 1/4" W. X 1 1/2" H.	1 DOZ.
CHI-87511	OVAL PLATTER	12 3/4" L. X 10 1/4" W. X 1 1/2" H.	1 DOZ.
CHI-87512	OVAL PLATTER	12" L. X 10 1/2" W. X 1 1/2" H.	1 DOZ.
CHI-87513	OVAL PLATTER	13" L. X 11 3/8" W. X 1 1/2" H.	1 DOZ.
CHI-87514	OVAL PLATTER	11" L. X 7 7/8" W. X 1 1/2" H.	1 DOZ.
CHI-87515	OVAL PLATTER	12 1/2" L. X 9" W. X 1 3/4" H.	1 DOZ.
CHI-87516	SQUARE PLATE	5 1/4" SQ. X 3/4" H.	3 DOZ.
CHI-87517	SQUARE PLATE	6 1/4" SQ. X 3/4" H.	3 DOZ.
CHI-87518	SQUARE PLATE	7 1/2" SQ. X 3/4" H.	3 DOZ.
CHI-87519	SQUARE PLATE	9 1/4" SQ. X 1" H.	2 DOZ.
CHI-87520	SQUARE PLATE	10" SQ. X 1 1/4" H.	1 DOZ.
CHI-87521	SQUARE PLATE	11 1/4" SQ. X 1 1/4" H.	1 DOZ.
CHI-87522	SQUARE PLATE	12 1/4" SQ. X 1 1/2" H.	1 DOZ.
CHI-87523	RECTANGULAR PLATTER	10 1/2" L. X 7 3/8" W. X 3/4" H.	2 DOZ.
CHI-87524	RECTANGULAR PLATTER	12 1/4" L. X 9" W. X 1" H.	1 DOZ.
CHI-87525	RECTANGULAR PLATTER	13 1/4" L. X 9 1/2" W. X 1" H.	1 DOZ.
CHI-87526	RECTANGULAR PLATTER	14 1/2" L. X 9 3/4" W. X 1 1/4" H.	1 DOZ.
CHI-87527	CURVED RECTANGULAR PLATTER	9 3/4" L. X 5 1/2" W. X 1" H.	2 DOZ.
CHI-87528	CURVED RECTANGULAR PLATTER	12" L. X 6 5/8" W. X 1 1/8" H.	1 DOZ.
CHI-87529	CURVED RECTANGULAR PLATTER	13 3/4" L. X 7 3/4" W. X 1 3/8" H.	1 DOZ.
CHI-87530	BOWL	16 OZ., 7" SQ. X 1 3/4" H.	3 DOZ.
CHI-87531	BOWL	28 OZ., 8" SQ. X 2 1/8" H.	2 DOZ.
CHI-87532	BOWL	40 OZ., 9" SQ. X 2 1/2" H.	1 DOZ.
CHI-87533	CUP	8.5 OZ., 3" SQ. X 2 3/4" H.	3 DOZ.
CHI-87534	SAUCER FOR 8.5 OZ. CUP	5 3/4" SQ. X 3/4" H.	3 DOZ.



## MAREA

THE MAREA COLLECTION IS A BEAUTIFUL AQUA BLUE COLOR WITH A FULLY VITRIFIED PORCELAIN BODY. IT IS MICROWAVE, DISHWASHER, AND OVEN SAFE. SOLD IN THE CASE PACKS ONLY. THREE YEAR MANUFACTURER'S CHIP WARRANTY.

			CASE PACK
CHI-135000	SALAD PLATE	8" DIA.	1 DOZ.
CHI-135001	DINNER PLATE	10 1/4" DIA.	1 DOZ.
CHI-135002	DINNER PLATE	11" DIA.	1 DOZ.
CHI-135003	PASTA BOWL	11" DIA.	1 DOZ.
CHI-135004	MUG	9 1/2" OZ., 3" DIA. X 3" H.	1 DOZ.
CHI-135005	TEA CUP	7 1/2" OZ., 3" DIA. X 3" H.	1 DOZ.
CHI-135006	SAUCER FOR TEA CUP	6" DIA.	2 DOZ.
CHI-135007	RAMEKIN	2 OZ., 3" DIA. X 2" H.	2 DOZ.
CHI-135008	BOWL	6 OZ., 4" DIA. X 2" H.	1 DOZ.
CHI-135009	BOWL	26 OZ., 7" DIA. X 2 3/4" H.	1 DOZ.
CHI-135010	SALAD BOWL	40 OZ., 9 1/4" DIA. X 3 1/4" H.	1 DOZ.
CHI-135011	SHARED BOWL	52 OZ., 10 1/4" DIA. X 4 1/4" H.	1 DOZ.



## HARBOUR

THE HARBOUR COLLECTION IS A REACTIVE GREY COLOR WITH A FULLY VITRIFIED PORCELAIN BODY. IT IS MICROWAVE, DISHWASHER, AND OVEN SAFE. SOLD IN THE CASE PACKS ONLY. THREE YEAR MANUFACTURER'S CHIP WARRANTY.

			CASE PACK
CHI-138000	SALAD PLATE	8 1/2" DIA.	1 DOZ.
CHI-138001	PLATE	9" DIA.	1 DOZ.
CHI-138002	DINNER PLATE	11 1/2" DIA.	1 DOZ.
CHI-138003	OVAL PLATE	8" L. X 1 1/4" H.	1 DOZ.
CHI-138004	OVAL PLATE	10" L. X 1 1/2" H.	1 DOZ.
CHI-138005	OVAL PLATE	11" L. X 1 1/2" H.	1 DOZ.
CHI-138006	MUG	11 OZ., 3 1/4" DIA. X 3 1/2" H.	1 DOZ.
CHI-138007	ESPRESSO CUP	3 OZ., 2 1/2" DIA. X 2 3/4" H.	1 DOZ.
CHI-138008	SAUCER FOR ESPRESSO CUP	5" DIA.	2 DOZ.
CHI-138009	TEA CUP	6 OZ., 3" DIA. X 2 3/4" H.	1 DOZ.
CHI-138010	SAUCER FOR TEA CUP	6 1/4" DIA.	2 DOZ.
CHI-138011	BOWL	8 OZ., 4 7/10" X 2 1/4" H.	1 DOZ.
CHI-138012	BOWL	14 OZ., 5 1/2" X 2 1/4" H.	1 DOZ.
CHI-138013	BOWL	22 OZ., 7 1/2" X 3" H.	1 DOZ.
CHI-138014	BOWL	40 OZ., 8 1/2" X 3" H.	1 DOZ.
CHI-138015	SALT & PEPPER SHAKERS	2 1/4" DIA. X 1" H.	1 DOZ.
CHI-138016	CREAMER WITHOUT HANDLE	3 OZ., 2 1/4" L. X 1" H.	1 DOZ.



## WELSH RABBIT OVAL DISHES

			CASE PACK
CHI-5315	AMERICAN WHITE	8 3/4" x 5" x 1", 8 OZ.	3 DOZ.
CHI-5316	PORCELAIN WHITE	8 3/4" x 5" x 1", 8 OZ.	3 DOZ.
CHI-5317	AMERICAN WHITE INSIDE/ BROWN OUTSIDE	8 3/4" x 5" x 1", 8 OZ.	3 DOZ.

# DINNERWARE



## BROWNFIELD DINNERWARE

PATTERN FEATURES COUPE STYLE PLATES. SOLD IN CASE PACKS ONLY.



## SAVANNAH

THIS REFRESHING DESIGN IS INSPIRED BY ORGANIC TEXTURES AND COLORS. THE SAVANNAH DINNERWARE OFFERS A RUSTIC LOOK THAT WILL GIVE YOUR TABLETOP A NATURAL LOOK. EACH ITEM IS AVAILABLE IN THREE COLORS, TERRACOTTA, BASIL, AND KHAKI. THEY ARE SOLD IN THE CASE PACKS ONLY.

Product Code	Item Name	Dimensions	Case Pack
CHI-32000	SQUARE PLATE	6 1/4" SQ.	1 DOZ.
CHI-32001	SQUARE PLATE	8" SQ.	1 DOZ.
CHI-32002	SQUARE PLATE	9 3/4" SQ.	1 DOZ.
CHI-32003	SQUARE PLATE	11 3/4" SQ.	1 DOZ.
CHI-32004	RECTANGULAR PLATTER	6 3/4" L. x 4 3/4" W.	1 DOZ.
CHI-32005	RECTANGULAR PLATTER	10 3/4" L. x 7 3/4" W.	1 DOZ.
CHI-32006	RECTANGULAR PLATTER	12 1/4" L. x 7 3/8" W.	1 DOZ.
CHI-32007	BOWL	3.5 OZ., 4" L. x 2 7/8" W.	1 DOZ.
CHI-32008	BOWL	11 OZ., 6 1/2" L. x 4 1/2" W.	1 DOZ.
CHI-32009	BOWL	24 OZ., 8" L. x 5 7/8" W.	1 DOZ.
CHI-32010	BOWL	42 OZ., 9 3/4" L. x 7 1/2" W.	1 DOZ.
CHI-32011	MUG	16 OZ.	1 DOZ.
CHI-32012	TALL CUP	9 OZ.	1 DOZ.
CHI-32013	TALL MUG	13 OZ.	1 DOZ.
CHI-32014	SQUARE SAUCER	5 3/4"	1 DOZ.
CHI-32015	SUGAR PACKET HOLDER	4 3/4" L. x 2 3/4" W. x 2 1/4" H.	1 DOZ.
CHI-32016	SALT & PEPPER SHAKER	1 1/2" W. x 2 1/4" H.	1 DOZ.

Item Name	Product Code	Case Pack
6 1/2" DIA. COUPE PLATE	CHI-414372204	3 DOZ.
7 3/4" DIA. COUPE PLATE	CHI-414372206	3 DOZ.
10 3/8" DIA. COUPE PLATE	CHI-414372208	1 DOZ.
11 5/8" DIA. COUPE PLATE	CHI-414372210	1 DOZ.
10 1/8" x 7 3/4" PLATTER	CHI-414372234	1 DOZ.
12 3/8" x 9 3/8" PLATTER	CHI-414372238	1 DOZ.
41 OZ., 11 1/2" DIA. DEEP PASTA PLATE	CHI-414372224	1 DOZ.
10 1/8" DIA. DEEP SALAD PLATE	CHI-414372205	1 DOZ.
7 3/4" DIA. SOUP BOWL	CHI-414372226	1 DOZ.
11 1/2" DIA. CORONET BOWL	CHI-414372237	1 DOZ.
14 OZ. CAFÉ MUG	CHI-414372240	1 DOZ.
8 OZ. COFFEE CUP	CHI-414372230	1 DOZ.
6 1/2" DIA. SAUCER FOR MUG AND CUP	CHI-414372215	3 DOZ.



Item Name	Product Code	Case Pack
FRUIT DISH	CHI-417001128	3 DOZ.
DEEP PASTA BOWL	CHI-417002204	3 DOZ.
	CHI-417002206	3 DOZ.
	CHI-417002208	1 DOZ.
	CHI-417002223	3 DOZ.
	CHI-417002224	1 DOZ.
	CHI-417002226	1 DOZ.
	CHI-417002234	1 DOZ.
RICE BOWL	CHI-417001128	14 OZ., 5 1/8" DIA. 3 DOZ.
BREAD & BUTTER PLATE	CHI-417002204	6" DIA. 3 DOZ.
SALAD/DESSERT PLATE	CHI-417002206	7 3/4" DIA. 3 DOZ.
DINNER PLATE	CHI-417002208	10 3/8" DIA. 1 DOZ.
FRUIT DISH	CHI-417002223	6 OZ., 5 1/4" DIA. 3 DOZ.
DEEP PASTA BOWL	CHI-417002224	41 OZ., 11 1/2" DIA. 1 DOZ.
SOUP BOWL	CHI-417002226	27 OZ., 7 3/4" DIA. 1 DOZ.
OBLONG PLATTER	CHI-417002234	10 1/8" X 7 3/4" 1 DOZ.

# DINNERWARE



**NEW!**

### BLUSH

THE BLUSH COLLECTION IS A BEAUTIFUL PINK COLOR WITH A FULLY VITRIFIED PORCELAIN BODY. IT IS MICROWAVE, DISHWASHER, AND OVEN SAFE. SOLD IN THE CASE PACKS ONLY. THREE YEAR MANUFACTURER'S CHIP WARRANTY.

			CASE PACK
CHI-137000	SIDE PLATE	7"	1 DOZ.
CHI-137001	SIDE PLATE	8" DIA.	1 DOZ.
CHI-137002	DINNER PLATE	10" DIA.	1 DOZ.
CHI-137003	SOUP PLATE	32 OZ., 10" DIA. x 2" H.	1 DOZ.
CHI-137004	SOUP PLATE	50 OZ., 12" DIA. x 2 1/4" H.	1 DOZ.
CHI-137005	MUG	9.5 OZ., 3 1/4" DIA. x 3 1/2" H.	1 DOZ.
CHI-137006	COFFEE CUP	6.75 OZ., 3 1/2" DIA. x 3" H.	1 DOZ.
CHI-137007	SAUCER FOR COFFEE CUP	4 1/2" DIA.	2 DOZ.
CHI-137008	SOUP BOWL	10 OZ., 3 3/5" DIA. x 2 1/2" H.	1 DOZ.
CHI-137009	SOUP BOWL	15 OZ., 6" DIA. x 3" H.	1 DOZ.
CHI-137010	SOUP BOWL	32 OZ., 8" DIA. x 3 3/4" H.	1 DOZ.
CHI-137011	SOUP BOWL	70 OZ., 10" DIA. x 4 1/4" H.	1 DOZ.
CHI-137012	RAMEKIN	2 OZ., 2" DIA. x 1" H.	2 DOZ.
CHI-137013	RAMEKIN	4 OZ., 2 1/2" DIA. x 1 1/2" H.	2 DOZ.



**NEW!**

### ALEXA®

ALEXA® IS ONE OF THE MOST POPULAR CHINA CHOICES FOR THE CATERING AND EVENT MANAGEMENT INDUSTRY. THE SOPHISTICATED LOOK IS MERGED WITH A LIGHT BODY THAT IS GEARED TOWARDS THE HECTIC SCHEDULE OF A BANQUET HALL. THEY ARE SOLD IN THE CASE PACKS ONLY AND CAN HAVE UP TO A TWO WEEK LEAD TIME FOR SHIPPING. IT COMES WITH A LIFETIME LIMITED NO CHIP WARRANTY FROM THE MANUFACTURER. LEAD FREE. MADE IN THE USA.

			CASE PACK
CHI-68002004	PLATE	6 1/2" DIA.	3 DOZ.
CHI-68002007	PLATE	9" DIA.	2 DOZ.
CHI-68002008	PLATE	10 3/8" DIA.	1 DOZ.
CHI-68002010	PLATE	11 5/8" DIA.	1 DOZ.
CHI-68002020	OVAL PLATTER	11 1/4"	1 DOZ.
CHI-68002005	PLATE	10 1/8" DIA.	1 DOZ.
CHI-68002000	BOUILLION BOWL	14 OZ., 4 1/4" DIA.	1 DOZ.
CHI-68002001	STACKABLE BOUILLION BOWL	13 OZ., 4" DIA.	1 DOZ.
CHI-68002015	SAUCER, FITS CAFÉ MUG, 11 OZ. CUP, & 8 OZ. CUP	6 1/2" DIA.	3 DOZ.
CHI-68002023	FRUIT BOWL	6 OZ., 5 1/4" DIA.	3 DOZ.
CHI-68002024	PASTA BOWL	41 OZ., 11 1/2" DIA.	1 DOZ.
CHI-68002040	CAFÉ MUG	14 OZ.	1 DOZ.
CHI-68002027	CUP	11 OZ.	1 DOZ.
CHI-68002030	CUP	8 OZ.	1 DOZ.



**NEW!**

### EROS

THE EROS COLLECTION IS A REACTIVE BLACK COLOR WITH A FULLY VITRIFIED PORCELAIN BODY. IT IS MICROWAVE, DISHWASHER, AND OVEN SAFE. SOLD IN THE CASE PACKS ONLY. THREE YEAR MANUFACTURER'S CHIP WARRANTY.

			CASE PACK
CHI-136000	BREAD AND BUTTER PLATE	6" DIA.	1 DOZ.
CHI-136001	SIDE PLATE	8" DIA.	1 DOZ.
CHI-136002	SALAD PLATE	8 1/2" DIA.	1 DOZ.
CHI-136003	PLATE	9" DIA.	1 DOZ.
CHI-136004	DINNER PLATE	10 1/4" DIA.	1 DOZ.
CHI-136005	DINNER PLATE	11 1/2" DIA.	1 DOZ.
CHI-136006	DEEP PLATE	42 OZ., 9 1/2" DIA. x 1 1/2" H.	1 DOZ.
CHI-136007	OVAL PLATE	8" DIA. x 1 1/4" H.	1 DOZ.
CHI-136008	OVAL PLATE	10" DIA. x 1 1/2" H.	1 DOZ.
CHI-136009	OVAL PLATE	11" DIA. x 1 1/2" H.	1 DOZ.
CHI-136010	MUG	11 OZ., 3 1/4" DIA. x 3 1/2" H.	1 DOZ.
CHI-136011	ESPRESSO CUP	3 OZ., 3 1/2" DIA. x 2 3/4" H.	1 DOZ.
CHI-136012	SAUCER FOR ESPRESSO CUP	5" DIA.	2 DOZ.
CHI-136013	TEA CUP	6 OZ., 3" DIA. x 2 3/4" H.	1 DOZ.
CHI-136014	SAUCER FOR ESPRESSO CUP	6 1/4" DIA.	2 DOZ.
CHI-136015	SALAD BOWL	30 OZ., 9 1/4" DIA. x 4 1/4" H.	1 DOZ.
CHI-136016	SALAD BOWL	40 OZ., 8" DIA. x 4" H.	1 DOZ.
CHI-136017	BOWL	8 OZ., 4 7/10" x 2 1/4" H.	1 DOZ.
CHI-136018	BOWL	8 OZ., 4 1/2" x 2 1/4" H.	1 DOZ.
CHI-136019	BOWL	14 OZ., 5 1/2" x 2 1/4" H.	1 DOZ.
CHI-136020	BOWL	20 OZ., 6" x 2 3/4" H.	1 DOZ.
CHI-136021	BOWL	22 OZ., 7" x 3" H.	1 DOZ.
CHI-136022	BOWL	40 OZ., 8 1/2" x 3" H.	1 DOZ.
CHI-136023	BOWL	56 OZ., 8" x 3 1/4" H.	1 DOZ.
CHI-136024	REMEKING	4 OZ., 2 1/2" DIA. x 1 1/2" H.	2 DOZ.
CHI-136025	SALT & PEPPER SHAKERS	2 1/4" DIA. x 1" H.	1 DOZ.
CHI-136026	CREAMER WITHOUT HANDLE	3 OZ., 3 1/2" L. x 2" H.	2 DOZ.



### KENSINGTON™

KENSINGTON™ TRANSCENDS ELEGANCE WITH ITS EMBOSSED LATTICE SCULPTING AND DETAILED POINTED-ARCH PATTERN. THEY ARE SOLD IN THE CASE PACKS ONLY AND CAN HAVE UP TO A TWO WEEK LEAD TIME FOR SHIPPING. IT COMES WITH A LIFETIME LIMITED NO CHIP WARRANTY FROM THE MANUFACTURER. LEAD FREE. MADE IN THE USA. CUSTOM BANDING IS AVAILABLE UPON REQUEST. PLEASE SEE THE OPTIONS BELOW AND CONTACT OUR SALES TEAM AT 1-508-892-9618 FOR A CUSTOM QUOTE.

			CASE PACK
CHI-6900874	PLATE	6 1/4" DIA.	3 DOZ.
CHI-6900876	PLATE	8 1/8" DIA.	3 DOZ.
CHI-6900877	PLATE	9" DIA.	2 DOZ.
CHI-6900879	PLATE	10 1/2" DIA.	1 DOZ.
CHI-6900869	RIM SOUP BOWL	9" DIA.	2 DOZ.
CHI-6900873	STACKABLE MUG	8 OZ.	3 DOZ.
CHI-6900875	FRUIT BOWL	1 1/2 OZ., 5" DIA.	3 DOZ.
CHI-6900881	GRAPEFRUIT BOWL	10 OZ., 7 1/4" DIA.	2 DOZ.
CHI-6900884	SAUCER FOR 7 OZ. CUP	5 5/8" DIA.	3 DOZ.
CHI-6900885	STACKABLE BOUILLION BOWL	7 OZ., 3 1/2" DIA.	3 DOZ.
CHI-6900886	BOUILLION BOWL	7 OZ., 3 3/4" DIA.	3 DOZ.
CHI-6900887	CUP	7 OZ.	3 DOZ.



**NEW!**

### TIME SQUARE ARCTIC WHITE

TIME SQUARE IS ONE OF THE MOST POPULAR SQUARE CHINA CHOICES FOR THE CATERING AND EVENT MANAGEMENT INDUSTRY. THEY ARE SOLD IN THE CASE PACKS ONLY AND CAN HAVE UP TO A TWO WEEK LEAD TIME FOR SHIPPING. IT COMES WITH A LIFETIME LIMITED NO CHIP WARRANTY FROM THE MANUFACTURER. LEAD FREE. MADE IN THE USA.

			CASE PACK
CHI-10000085	PLATE	7 3/8" DIA.	1 DOZ.
CHI-10000083	PLATE	8 1/2" DIA.	1 DOZ.
CHI-10000087	PLATE	10" DIA.	1 DOZ.
CHI-10000725	BOWL	16 OZ., 6 1/2" DIA.	2 DOZ.
CHI-10000078	PLATTER	5" X 11 3/8"	1 DOZ.
CHI-10000105	CUP	7 3/4 OZ.	3 DOZ.
CHI-100002822	SAUCER	6"	3 DOZ.



**NEW!**

### TIME SQUARE IVORY

TIME SQUARE IS ONE OF THE MOST POPULAR SQUARE CHINA CHOICES FOR THE CATERING AND EVENT MANAGEMENT INDUSTRY. THEY ARE SOLD IN THE CASE PACKS ONLY AND CAN HAVE UP TO A TWO WEEK LEAD TIME FOR SHIPPING. IT COMES WITH A LIFETIME LIMITED NO CHIP WARRANTY FROM THE MANUFACTURER. LEAD FREE. MADE IN THE USA.

			CASE PACK
CHI-00085	PLATE	7 3/8" DIA.	1 DOZ.
CHI-00083	PLATE	8 1/2" DIA.	1 DOZ.
CHI-00087	PLATE	10" DIA.	1 DOZ.
CHI-00725	BOWL	16 OZ., 6 1/2" DIA.	2 DOZ.
CHI-00078	PLATTER	5" X 11 3/8"	1 DOZ.
CHI-00105	CUP	7 3/4 OZ.	3 DOZ.
CHI-00282	SAUCER	6"	3 DOZ.



# DINNERWARE



**NEW!**

### BLUE WILLOW

THE BLUE WILLOW DINNERWARE IS A TRADITIONAL EMBELLISHED BLUE DESIGN ON AN IVORY ROLLED EDGE PATTERN. THIS PATTERN HAS A HEAVY-GAUGE DURABLE BODY THAT IS HIGH-FIRE AND GLAZED AND THAT IS EXCEPTIONALLY DURABLE AND RESISTS SCRATCHES, CHIPPING, AND OFFERS SUPERIOR HEAT RETENTION. THIS PATTERN IS SOLD IN CASE PACKS ONLY AND CAN HAVE UP TO A SIX WEEK LEAD TIME FOR SHIPPING SINCE IT IS A CUSTOM MADE TO ORDER PATTERN. ADDITIONAL PIECES ARE AVAILABLE, PLEASE CALL OUR SALES TEAM AT 508-892-9618 FOR SPECIAL QUOTING. THE PATTERN COMES WITH A LIFETIME LIMITED NO CHIP WARRANTY FROM THE MANUFACTURER. LEAD FREE AND MADE IN THE USA.

			CASE PACK
CHI-99680101	BOUILLON BOWL	7 1/4 OZ., 3 7/8" DIA.	3 DOZ.
CHI-99680102	CUP	7 1/2 OZ.	3 DOZ.
CHI-99680162	FRUIT BOWL	4 1/2 OZ., 4 1/4" DIA.	3 DOZ.
CHI-99680170	GRAPEFRUIT BOWL	9 OZ., 6 3/8" DIA.	3 DOZ.
CHI-99680201	PLATE	6 1/4" DIA.	3 DOZ.
CHI-99680204	PLATE	8 1/4" DIA.	3 DOZ.
CHI-99680206	PLATE	9 5/8" DIA.	2 DOZ.
CHI-99680281	SAUCER	5 1/2" DIA.	3 DOZ.



**NEW!**

### LACOSTA PEACH

THE BEAUTIFUL LACOSTA PEACH CHINA PATTERN HAS A UNIQUE SCULPTED PEACH RING WITH PLATINUM SILVER ACCENT LINE THAT SURROUNDS THE PLATE WELL OFFERING A BEAUTIFUL MOLDED-IN DESIGN ON IVORY DINNERWARE. THE PERFECT DELICATE ACCENT FOR ANY SPECIALTY TABLETOP PRESENTATION. THIS PATTERN HAS A HEAVY-GAUGE DURABLE BODY THAT IS HIGH-FIRE AND GLAZED AND THAT IS EXCEPTIONALLY DURABLE AND RESISTS SCRATCHES, CHIPPING, AND OFFERS SUPERIOR HEAT RETENTION. THIS PATTERN IS DISHWASHER SAFE, MICROWAVE SAFE, AND OVEN SAFE. THIS PATTERN IS SOLD IN CASE PACKS ONLY AND CAN HAVE UP TO A SIX WEEK LEAD TIME FOR SHIPPING SINCE IT IS A CUSTOM MADE TO ORDER PATTERN. ADDITIONAL PIECES ARE AVAILABLE, PLEASE CALL OUR SALES TEAM AT 508-892-9618 FOR SPECIAL QUOTING. THE PATTERN COMES WITH A LIFETIME LIMITED NO CHIP WARRANTY FROM THE MANUFACTURER. LEAD FREE AND MADE IN THE USA.

			CASE PACK
CHI-11490095	BOUILLON BOWL	7 3/4 OZ.	3 DOZ.
CHI-11490112	CUP	7 3/4 OZ.	3 DOZ.
CHI-11490286	SAUCE	5 5/8" DIA.	3 DOZ.
CHI-11490366	PLATE	6 1/4" DIA.	3 DOZ.
CHI-11490368	PLATE	8 1/8" DIA.	3 DOZ.
CHI-11490370	PLATE	9 7/8" DIA.	2 DOZ.
CHI-11490371	PLATE	10 5/8" DIA.	1 DOZ.
CHI-11490372	PLATE	11" DIA.	1 DOZ.
CHI-11490374	GRAPEFRUIT BOWL	9 1/2 OZ., 7 1/4" DIA.	3 DOZ.
CHI-11490375	FRUIT BOWL	4 1/2 OZ., 5 1/2" DIA.	3 DOZ.



**NEW!**

### INVERNESS BLACK

THE DRAMATIC BLACK AND GOLD INVERNESS CHINA PATTERN HAS A UNIQUE SCULPTED DRAMATIC BLACK RING WITH DOUBLE THIN GOLD ACCENT LINES AND EXTERIOR DELICATE GOLD BAND THAT COMPLIMENTS THE PLATE AND OFFERS A DRAMATIC MOLDED-IN DESIGN ON IVORY DINNERWARE. THE PERFECT DRAMATIC ACCENT FOR ANY SPECIALTY TABLETOP PRESENTATION. THIS PATTERN HAS A HEAVY-GAUGE DURABLE BODY THAT IS HIGH-FIRE AND GLAZED AND THAT IS EXCEPTIONALLY DURABLE AND RESISTS SCRATCHES, CHIPPING, AND OFFERS SUPERIOR HEAT RETENTION. THIS PATTERN FEATURES PRECIOUS GOLD METAL BANDING AND SHOULD BE HAND WASHED ONLY AND IS NOT MICROWAVEABLE SAFE. THIS PATTERN IS SOLD IN CASE PACKS ONLY AND CAN HAVE UP TO A SIX WEEK LEAD TIME FOR SHIPPING SINCE IT IS A CUSTOM MADE TO ORDER PATTERN. ADDITIONAL PIECES ARE AVAILABLE, PLEASE CALL OUR SALES TEAM AT 508-892-9618 FOR SPECIAL QUOTING. THE PATTERN COMES WITH A LIFETIME LIMITED NO CHIP WARRANTY FROM THE MANUFACTURER. LEAD FREE AND MADE IN THE USA.

			CASE PACK
CHI-1469095	BOUILLON BOWL	7 3/4 OZ.	3 DOZ.
CHI-1469112	CUP	7 3/4 OZ.	3 DOZ.
CHI-1469286	SAUCE	5 5/8" DIA.	3 DOZ.
CHI-1469366	PLATE	6 1/4" DIA.	3 DOZ.
CHI-1469368	PLATE	8 1/8" DIA.	3 DOZ.
CHI-1469370	PLATE	9 7/8" DIA.	2 DOZ.
CHI-1469371	PLATE	10 5/8" DIA.	1 DOZ.
CHI-1469372	PLATE	11" DIA.	1 DOZ.
CHI-1469374	GRAPEFRUIT BOWL	9 1/2 OZ., 7 1/4" DIA.	3 DOZ.
CHI-1469375	FRUIT BOWL	4 1/2 OZ., 5 1/2" DIA.	3 DOZ.



**NEW!**

### FOX FERN

THE FOX FERN DINNERWARE IS A TRADITIONAL RETRO DESIGN SCALLOPED EDGE IVORY BODY PATTERN WITH RED ACCENTED DESIGN. THIS PATTERN HAS A HEAVY-GAUGE DURABLE BODY THAT IS HIGH-FIRE AND GLAZED AND THAT IS EXCEPTIONALLY DURABLE AND RESISTS SCRATCHES, CHIPPING, AND OFFERS SUPERIOR HEAT RETENTION. THIS CHINA IS ALSO FULLY VITRIFIED AND OVEN SAFE FOR UP TO 450 DEGREES. THIS PRODUCT IS SOLD IN THE CASE PACKS ONLY AND CAN HAVE UP TO A SIX WEEK LEAD TIME FOR SHIPPING SINCE IT IS A CUSTOM MADE TO ORDER PATTERN. ADDITIONAL PIECES ARE NOT SHOWN ARE ALSO AVAILABLE, PLEASE CALL OUR SALES TEAM AT 508-892-9618 FOR INFORMATION AND QUOTED PRICING. THE PATTERN COMES WITH A LIFETIME LIMITED NO CHIP WARRANTY FROM THE MANUFACTURER. LEAD FREE AND MADE IN THE USA.

			CASE PACK
CHI-92091126	PASTA PLATE	12 OZ., 11 1/2" DIA.	1 DOZ.
CHI-92091127	MUG	13 1/2 OZ.	1 DOZ.
CHI-9209508	CUP	7 1/2 OZ.	3 DOZ.
CHI-9209523	OVAL PLATTER	7 3/4"	3 DOZ.
CHI-9209525	OVAL PLATTER	9 7/8"	2 DOZ.
CHI-9209526	OVAL PLATTER	11 3/4"	1 DOZ.
CHI-9209527	OVAL PLATTER	12 5/8"	1 DOZ.
CHI-9209529	PRINCESS FRUIT BOWL	3 1/2 OZ., 4 5/8" DIA.	3 DOZ.
CHI-9209533	GRAPEFRUIT BOWL	12 1/4 OZ.	3 DOZ.
CHI-9209541	PLATE	6 1/4" DIA.	3 DOZ.
CHI-9209542	PLATE	7 1/4" DIA.	3 DOZ.
CHI-9209544	PLATE	9" DIA.	2 DOZ.
CHI-9209546	PLATE	9 3/4" DIA.	2 DOZ.
CHI-9209548	PLATE	10 5/8" DIA.	1 DOZ.
CHI-9209564	RIM SOUP BOWL	12 3/4 OZ., 8 1/8" DIA.	2 DOZ.
CHI-9209580	SAUCER FOR 7 1/4 OZ. CUP	5 5/8"	3 DOZ.



**NEW!**

### AMERICAN ROSE BLUE

THE RETRO AMERICAN ROSE BLUE DINNERWARE IS A TRADITIONAL ROLLED EDGE DINNERWARE THAT FEATURES A WIDE, FOOD FRAMING DECORATIVE BLUE RIM DESIGN ON AN IVORY ROLLED EDGE BODY PATTERN. THIS PATTERN FEATURES A HIGH-FIRE, LEAD-FREE GLAZE THAT CREATES A HEAVY GAUGE BODY WITH EXCEPTIONAL DURABILITY AND THAT IS SCRATCH, CHIP, AND IMPACT RESISTANT. THE PRODUCT ALSO FEATURES SUPERIOR HEAT RETENTION TO ENSURE FOOD STAYS WARM WHEN SERVING. THIS COLLECTION IS SOLD IN THE CASE PACKS LISTED ONLY AND THIS PATTERN CAN HAVE UP TO A SIX WEEK LEAD TIME FOR SHIPPING SINCE IT IS A CUSTOM PATTERN THAT IS MADE TO ORDER. ADDITIONAL PIECES NOT SHOWN ARE ALSO AVAILABLE. PLEASE CALL OUR SALES TEAM AT 1-508-892-9618 FOR SPECIAL QUOTED PRICING. THIS PATTERN FEATURES A LIFETIME LIMITED LIFETIME NO CHIP WARRANTY FROM THE MANUFACTURER. LEAD FREE AND MADE IN THE USA.

			CASE PACK
CHI-50350101	BOUILLON BOWL	7 1/4 OZ., 3 7/8" DIA.	3 DOZ.
CHI-50350104	CUP	7 OZ.	3 DOZ.
CHI-50350162	FRUIT BOWL	4 1/2 OZ., 4 1/4" DIA.	3 DOZ.
CHI-50350170	GRAPEFRUIT BOWL	9 OZ., 6 3/8" DIA.	3 DOZ.
CHI-50350201	PLATE	6 1/4" DIA.	3 DOZ.
CHI-50350204	PLATE	8 1/4" DIA.	3 DOZ.
CHI-50350206	PLATE	9 5/8" DIA.	2 DOZ.
CHI-50350208	PLATE	11 1/8" DIA.	1 DOZ.
CHI-50350283	SAUCER	5 1/2" DIA.	3 DOZ.



### FLEUR DINNERWARE

ARCOROC FULLY TEMPERED. SOLD IN CASE PACKS ONLY!

			CASE PACK
DNWR-8007510	PLATE	9"	3 DOZ.
DNWR-8007684	DEEP SALAD BOWL	8"	3 DOZ.
DNWR-8009423	DESSERT	7 1/2"	3 DOZ.

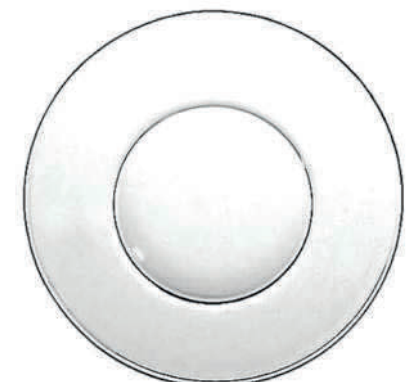

### PLATES & BOWLS (GLASS)

SOLD IN CASE PACKS ONLY.

			CASE PACK
DNWR-8801	PLATE	10" D. x 1" H.	2 DOZ.
DNWR-8828	PLATE	6 1/4" D. x 3/4" H.	3 DOZ.
DNWR-8842	PLATE	8" D. x 7/8" H.	3 DOZ.

# DINNERWARE



### SOHO (MELAMINE)

100% BPA FREE. BREAK-RESISTANT. COMMERCIAL DISHWASHER SAFE. NSF CERTIFIED. SOLD IN CASE PACKS ONLY!

Item #	Description	Dimensions	Case Pack
CHI-2263	RECTANGULAR PLATTER	17 1/4" x 6 5/8" x 2"	6 EACH
CHI-2264	RECTANGULAR PLATTER	14" x 9 5/8" x 2"	6 EACH
CHI-2265	SQUARE PLATE	6" x 6"	1 DOZ.
CHI-2266	SQUARE PLATE	8" x 8"	1 DOZ.
CHI-2267	SQUARE PLATE	10" x 10"	1 DOZ.
CHI-2268	SQUARE PLATE	12" x 12"	6 EACH
CHI-2269	SQUARE PLATE	14" x 14"	6 EACH
CHI-2270	SQUARE PLATE	16" x 16"	6 EACH
CHI-2272	ROUND BOWL WITH HANDLES	2 QT., 12" DIA.	6 EACH
CHI-2273	ROUND BOWL WITH HANDLES	3 QT., 13" DIA.	6 EACH
CHI-2274	ROUND BOWL WITH HANDLES	4 QT., 14" DIA.	6 EACH
CHI-2275	OVAL PLATTER	18" x 13 1/2"	1 DOZ.
CHI-2276	OVAL PLATTER	21" x 15"	1 DOZ.



### VENETIAN (MELAMINE)

MADE OF DURABLE MELAMINE, DISHWASHER SAFE. SOLD IN CASE PACKS ONLY!

Item #	Description	Dimensions	Case Pack
CHI-7784	SQUARE PLATE	6" x 6"	1 DOZ.
CHI-7785	SQUARE PLATE	8" x 8"	1 DOZ.
CHI-7786	SQUARE PLATE	10" x 10"	1 DOZ.
CHI-7787	RECTANGULAR PLATTER	17 1/4" x 6 5/8" x 2"	6 EA.
CHI-7788	RECTANGULAR PLATTER	14" x 9 5/8" x 2"	6 EA.
CHI-7790	SQUARE PLATE	12" x 12"	6 EA.
CHI-7791	SQUARE PLATE	14" x 14"	6 EA.
CHI-7792	SQUARE PLATE	16" x 16"	6 EA.
CHI-7793	BOWL	2 QT., 12" DIA.	6 EA.
CHI-7794	BOWL	3 QT., 13" DIA.	6 EA.
CHI-7795	BOWL	4 QT., 14" DIA.	6 EA.
CHI-7796	OVAL PLATTER	18" x 13 1/2"	1 DOZ.
CHI-7797	OVAL PLATTER	21" x 15"	1 DOZ.



### MOSAIC (MELAMINE)

MADE FROM DURABLE, UNBREAKABLE MELAMINE. 100% BPA FREE. COMMERCIAL DISHWASHER SAFE. NSF CERTIFIED. SOLD IN CASE PACKS ONLY!

Item #	Description	Dimensions	Case Pack
CHI-7887	RECTANGULAR PLATTER	17 1/4" x 6 5/8" x 2"	6 EACH
CHI-7888	RECTANGULAR PLATTER	14" x 9 5/8" x 2"	6 EACH
CHI-7884	SQUARE PLATER	6" x 6"	2 EACH
CHI-7885	SQUARE PLATER	8" x 8"	1 DOZ.
CHI-7886	SQUARE PLATER	10" x 10"	1 DOZ.
CHI-7890	SQUARE PLATER	12" x 12"	6 EACH
CHI-7891	SQUARE PLATER	14" x 14"	6 EACH
CHI-7892	SQUARE PLATER	16" x 16"	6 EACH
CHI-7893	ROUND BOWL WITH HANDLES	2 QT., 12" DIA.	6 EACH
CHI-7894	ROUND BOWL WITH HANDLES	3 QT., 13" DIA.	6 EACH
CHI-7895	ROUND BOWL WITH HANDLES	4QT., 14" DIA.	6 EACH
CHI-7896	OVAL PLATTER	18" x 13 1/2"	1 DOZ.
CHI-7897	OVAL PLATTER	21" x 15"	1 DOZ.



### OLYMPIA (MELAMINE)

MADE FROM DURABLE, UNBREAKABLE MELAMINE. 100% BPA FREE. COMMERCIAL DISHWASHER SAFE. NSF CERTIFIED. SOLD IN CASE PACKS ONLY!

Item #	Description	Dimensions	Case Pack
CHI-7007	DISPLAY PEDESTAL, IVORY	8.5" x 7.7" x 3.15" H.	3 EACH
CHI-7684	SQUARE PLATE	6" x 6"	1 DOZ.
CHI-7685	SQUARE PLATE	8" x 8"	1 DOZ.
CHI-7686	SQUARE PLATE	10" x 10"	1 DOZ.
CHI-7687	RECTANGULAR PLATTER	17 1/4" x 6 5/8" x 2"	6 EACH
CHI-7688	RECTANGULAR PLATTER	14" x 9 5/8" x 2"	6 EACH
CHI-7690	SQUARE PLATE	12" x 12"	6 EACH
CHI-7691	SQUARE PLATE	14" x 14"	6 EACH
CHI-7692	SQUARE PLATE	16" x 16"	6 EACH
CHI-7693	ROUND BOWL WITH HANDLES	2 QT., 12" DIA.	6 EACH
CHI-7694	ROUND BOWL WITH HANDLES	3 QT., 13" DIA.	6 EACH
CHI-7695	ROUND BOWL WITH HANDLES	4 QT., 14" DIA.	6 EACH
CHI-7696	OVAL PLATTER	18" x 13 1/2"	1 DOZ.
CHI-7697	OVAL PLATTER	21" x 15"	1 DOZ.

CHI-7007  
DISPLAY PEDESTAL



### ISABELLA (MELAMINE)

THIS DINNERWARE COLLECTION HAS FIVE ELEGANT NORTHERN EUROPEAN DESIGNS TO MAKE YOUR TABLETOP STUNNING. IT IS CRAFTED FROM DURABLE MELAMINE TO BE USED INSIDE OR OUT. SOLD IN CASE PACKS ONLY.

**NEW!**

Item #	Description	Dimensions	Case Pack
CHI-29500		11" DIA. X 1" H.	12 EA.
CHI-29501	SCALLOPED EDGE PLATE	8 3/4" DIA. X 1" H.	12 EA.
CHI-29502	PLATE	6 1/2" DIA. X 5/8" H. B & B	12 EA.
CHI-29503	COUPE BOWL	6 OZ., 5" DIA X 1" H.	12 EA.
CHI-29504	RECTANGULAR PLATTER	14" L. X 5 5/8" W. X 1 1/4" H.	6 EA.



### MILANO (MELAMINE)

100% BPA FREE. BREAK-RESISTANT. COMMERCIAL DISHWASHER SAFE. NSF CERTIFIED. SOLD IN CASE PACKS ONLY! AVAILABLE IN BLACK (BK) OR WHITE (W). PLEASE SPECIFY COLOR WHEN ORDERING.



Item #	Description	Dimensions	Case Pack
CHI-2171		6" SQ.	1 DOZ.
CHI-2172		7 1/4" SQ.	1 DOZ.
CHI-2173		8 3/4" SQ.	1 DOZ.
CHI-2174		10 1/4" SQ.	1 DOZ.
CHI-2175		11 3/4" SQ.	1 DOZ.
CHI-2176		13 3/4" SQ.	6 EA.

# DINNERWARE



IVORY WIDE RIM PLATE



WHITE PASTA/SALAD BOWL



WHITE BOWL



IVORY STACKING CUP WITH SAUCER



WHITE NARROW RIM PLATE



WHITE SAUCER



WHITE STACKING SAN CUP

**DIAMOND IVORY AND DIAMOND WHITE (MELAMINE)**  
100% BPA FREE. BREAK-RESISTANT. COMMERCIAL DISHWASHER SAFE. NSF CERTIFIED. PLEASE SPECIFY COLOR IVORY OR WHITE WHEN ORDERING. SOLD IN CASE PACK DOZENS ONLY!



WHITE OVAL PLATTER



WHITE BOUILLON

Item #	Description	Size	Case Pack
CHI-18460	WIDE RIM PLATE	12" DIA.	1 DOZ.
CHI-18461	WIDE RIM PLATE	10 1/2" DIA.	1 DOZ.
CHI-18462	WIDE RIM PLATE	9" DIA.	2 DOZ.
CHI-18463	WIDE RIM PLATE	7 1/2" DIA.	4 DOZ.
CHI-18464	WIDE RIM PLATE	6 1/2" DIA.	4 DOZ.
CHI-18465	WIDE RIM PLATE	5 1/2" DIA.	4 DOZ.
CHI-18466	NARROW RIM PLATE	10 1/2" DIA.	1 DOZ.
CHI-18467	NARROW RIM PLATE	9" DIA.	2 DOZ.
CHI-18468	NARROW RIM PLATE	7 1/4" DIA.	4 DOZ.
CHI-18469	NARROW RIM PLATE	6 1/2" DIA.	4 DOZ.
CHI-18470	BOWL	16 OZ., 7 1/2" DIA.	2 DOZ.
CHI-18471	PASTA/SALAD BOWL	13 OZ., 9 1/2" DIA.	2 DOZ.
CHI-18472	BOWL	12 OZ., 7 1/2" DIA.	2 DOZ.
CHI-18473	PASTA/SALAD BOWL	10 OZ., 5 3/8" DIA.	4 DOZ.
CHI-18474	PASTA/SALAD BOWL	8 OZ., 6" DIA.	4 DOZ.
CHI-18476	BOUILLON	7 OZ.	4 DOZ.
CHI-18477	BOUILLON	8 OZ.	4 DOZ.
CHI-18479	SAUCER	5 1/2" DIA.	4 DOZ.
CHI-18480	FOR CHI-18473, CHI-18476, CHI-18477, CHI-18485		2 DOZ.
CHI-18481	OVAL PLATTER	9 1/2" x 7 1/4"	1 DOZ.
CHI-18482	OVAL PLATTER	12" x 9"	1 DOZ.
CHI-18482	OVAL PLATTER	13 1/2" x 10 1/2"	1 DOZ.
CHI-18484	STACKING MUG	8 OZ.	2 DOZ.
CHI-18487	STACKING SAN CUP	12 OZ.	2 DOZ.



TEXAS BLUE DINNERWARE

MADE FROM DURABLE, UNBREAKABLE MELAMINE. 100% BPA FREE. COMMERCIAL DISHWASHER SAFE. NSF CERTIFIED. SOLD IN CASE PACKS ONLY!

Item #	Description	Size	Case Pack
CHI-6600	ROUND PLATE	6.25" DIA.	4 DOZ.
CHI-6601	ROUND PLATE	7.25" DIA.	2 DOZ.
CHI-6602	ROUND PLATE	9" DIA.	2 DOZ.
CHI-6603	ROUND PLATE	10" DIA.	1 DOZ.
CHI-6604	BOWL	8 OZ., 4" DIA. x 2.25" DEEP	4 DOZ.
CHI-6605	BOWL	16 OZ., 5.25" DIA. x 2.5" DEEP	2 DOZ.
CHI-6606	BOWL	12 OZ., 5.25" DIA. x 2" DEEP	2 DOZ.
CHI-6607	BOWL	16 OZ., 11.25" DIA. x 1.75" DEEP	1 DOZ.
CHI-6608	BOWL	24 OZ., 12.5" DIA. x 2" DEEP	1 DOZ.
CHI-6609	OVAL PLATTER	11.5" x 8"	2 DOZ.
CHI-6610	OVAL PLATTER	11.5" x 8" x 0.75" DEEP	2 DOZ.
CHI-6611	OVAL PLATTER	14" x 10"	1 DOZ.
CHI-6612	OVAL PLATTER	16.25" x 12"	1 DOZ.
CHI-6613	OVAL PLATTER	12" x 9"	2 DOZ.
CHI-6614	OVAL PLATTER	14" x 9"	1 DOZ.
CHI-6615	OVAL PLATTER	9.75" x 7.25"	2 DOZ.
CHI-6616	BOWL	10 OZ., 6.25" DIA. x 1.5" DEEP	4 DOZ.
CHI-6617	BOWL	14 OZ., 7.25" DIA. x 1.75" DEEP	2 DOZ.
CHI-6618	BOWL	3.5 OZ., 5.25" DIA. x 1" DEEP	4 DOZ.
CHI-6619	SAN MUG	8 OZ., 3.25" DIA. x 3.5" DEEP	2 DOZ.
CHI-6620	MUG	11 OZ., 4" DIA., 2.25" DEEP	2 DOZ.



EPICURE ACACIA WOOD GRAIN COLLECTION

IT HAS THE CONVENIENCE OF DURABLE MELAMINE WITH THE POPULAR WOOD GRAIN LOOK. IT HAS THE LOOK OF WOOD GRAIN, BUT WITHOUT THE NEED TO HAND WASH OR SEASON. IT IS SAFE FOR TEMPERATURES UP TO 212°F. THE COLLECTION IS NSF LISTED, DISHWASHER SAFE, AND HAS A 2 YEAR LIMITED WARRANTY AGAINST BREAKAGE.

SOLD IN CASE PACKS ONLY!

Item #	Description	Size	Case Pack
AWG-1800	BOWL	7.5" DIA., 32 OZ.	12 EACH
AWG-1801	BOWL	12" DIA., 4.8 QT.	6 EACH
AWG-1802	OVAL PLATTER	18" x 15"	6 EACH
AWG-1803	RECTANGULAR TRAY	13.88" x 7.75"	12 EACH
AWG-1804	PLATTER	18" DIA.	6 EACH
AWG-1805	RECTANGULAR TRAY	14.75" x 6.75"	12 EACH
AWG-1806	DIP BOWL	4.38" DIA., 5 OZ.	12 EACH
AWG-1807	FLIGHT TRAY	13.19" DIA.	6 EACH
AWG-1808	PLATTER	19.25" DIA.	2 EACH
AWG-1809	SQUARE TRAY	9"	12 EACH



DINNERWARE (GLASS)

Item #	Description	Size	Case Pack
CHI-5802	SALAD/DESSERT PLATE	7.5" D. x 7/8" H.	1 DOZ.
CHI-5803	DINNER PLATE	10.5" D. x 1" H.	1 DOZ.
CHI-5804	SQUARE BOWL	5.5" SQ. x 2.5" H.	1 DOZ.
CHI-5805	SQUARE SALAD PLATE	8" SQ. x 5/8" H.	1 DOZ.
CHI-5806	SQUARE DINNER PLATE	10.25" SQ. x 7/8" H.	1 DOZ.
CHI-5807	SQUARE BOWL	9" SQ x 4" H.	1 DOZ.
CHI-5809	SALAD/DESSERT PLATE	6" D. x 3/4" H.	3 DOZ.
CHI-5810	SALAD/DESSERT PLATE	8" D. x 1/2" H.	3 DOZ.



MUG, CUP & SAUCER (GLASS)  
SOLD IN THE CASE PACKS ONLY.

Item #	Description	Size	Case Pack
GL-25190	STACKABLE MUG	8.5 OZ., 3 3/4" H. X 3" T. X 2 3/4" B.	2 DOZ.
GL-25191	CUP & SAUCER FULLY TEMPERED	8 OZ., 2 1/2" H. X 3 1/2" T. X 1 1/2" B.	2 DOZ.
GL-25192	MINI CUP & SAUCER	3 OZ., 2 1/4" H. X 2 1/2" T. X 1 1/4" B.	4 DOZ.

# PLATE COVERS

**QUICK SHIP!**



**PLATE COVERS (STAINLESS)**

SATIN FINISH STAINLESS STEEL. AVAILABLE IN STOCK FOR IMMEDIATE DELIVERY.

- AC-18338 PLATE COVER FOR ROUND PLATES 9" TO 9 1/8"
- AC-18339 PLATE COVER FOR ROUND PLATES 9 3/16" TO 9 1/4"
- AC-18340 PLATE COVER FOR ROUND PLATES 9 5/16" TO 9 3/8"
- AC-18341 PLATE COVER FOR ROUND PLATES 9 7/16" TO 9 1/2"
- AC-18342 PLATE COVER FOR ROUND PLATES 9 9/16" TO 9 5/8"
- AC-18343 PLATE COVER FOR ROUND PLATES 9 11/16" TO 9 3/4"
- AC-18344 PLATE COVER FOR ROUND PLATES 9 13/16" TO 9 7/8"
- AC-18345 PLATE COVER FOR ROUND PLATES 9 15/16" TO 10"
- AC-18346 PLATE COVER FOR ROUND PLATES 10 1/16" TO 10 1/8"
- AC-18347 PLATE COVER FOR ROUND PLATES 10 3/16" TO 10 1/4"
- AC-18348 PLATE COVER FOR ROUND PLATES 10 5/16" TO 10 3/8"
- AC-18349 PLATE COVER FOR ROUND PLATES 10 7/16" TO 10 1/2"
- AC-18350 PLATE COVER FOR ROUND PLATES 10 9/16" TO 10 5/8"
- AC-18351 PLATE COVER FOR ROUND PLATES 10 11/16" TO 10 3/4"
- AC-18352 PLATE COVER FOR ROUND PLATES 10 13/16" TO 10 7/8"
- AC-18353 PLATE COVER FOR ROUND PLATES 10 15/16" TO 11"
- AC-18354 PLATE COVER FOR ROUND PLATES 11 1/16" TO 11 1/8"
- AC-18355 PLATE COVER FOR ROUND PLATES 11 3/16" TO 11 1/4"
- AC-18356 PLATE COVER FOR ROUND PLATES 11 5/16" TO 11 3/8"
- AC-18357 PLATE COVER FOR ROUND PLATES 11 7/16" TO 11 1/2"
- AC-18358 PLATE COVER FOR ROUND PLATES 11 9/16" TO 11 5/8"
- AC-18359 PLATE COVER FOR ROUND PLATES 11 11/16" TO 11 3/4"
- AC-18360 PLATE COVER FOR ROUND PLATES 11 13/16" TO 11 7/8"
- AC-18361 PLATE COVER FOR ROUND PLATES 11 15/16" TO 12"
- AC-18362 PLATE COVER FOR ROUND PLATES 12 1/16" TO 12 1/8"
- AC-18363 PLATE COVER FOR ROUND PLATES 12 3/16" TO 12 1/4"
- AC-18364 PLATE COVER FOR ROUND PLATES 12 5/16" TO 12 3/8"
- AC-18365 PLATE COVER FOR ROUND PLATES 12 7/16" TO 12 1/2"
- AC-18366 PLATE COVER FOR ROUND PLATES 12 9/16" TO 12 5/8"
- AC-18367 PLATE COVER FOR ROUND PLATES 12 11/16" TO 12 3/4"



**CUSTOM PLATE COVERS (STAINLESS)**

FITS APPROX. 2" HIGH OVER THE PLATE. POLISHED ON SIDES WITH A SATIN FINISH TOP. MINIMUM ORDER 24 PIECES. (ESTIMATED LEAD TIME 15 BUSINESS DAYS)

- AC-18330 PLATE COVER FOR PLATES 4 1/2" - 6 3/4"
- AC-18331 PLATE COVER FOR PLATES 6 13/16" - 7 3/4"
- AC-18332 PLATE COVER FOR PLATES 7 13/16" - 8 11/16"
- AC-18333 PLATE COVER FOR PLATES 8 3/4" - 10"
- AC-18334 PLATE COVER FOR PLATES 10 1/16" - 10 7/8"
- AC-18335 PLATE COVER FOR PLATES 10 15/16" - 11 3/4"
- AC-18336 PLATE COVER FOR PLATES 1 13/16" - 12 3/4"
- AC-18337 PLATE COVER FOR PLATES 12 13/16" - 13 1/2"



**PLATE COVERS (18/8 STAINLESS STEEL)**

STACKABLE PLATE COVERS WITH ROLLED EDGE, HEAVY GAUGE, AND BRUSH FINISHED COVERS. FITS PLATE SIZES BELOW.

- AC-5240 PLATE COVER FOR PLATES 8 1/2" SQ.
- AC-5241 PLATE COVER FOR PLATES 9 7/8" SQ.
- AC-5242 PLATE COVER FOR PLATES 11 3/8" x 7" RECTANGULAR
- AC-5243 PLATE COVER FOR PLATES 14 1/2" x 7" RECTANGULAR



**PLATE COVERS (CLEAR POLYCARBONATE)**

HIGHLY HEAT AND BREAK RESISTANT, CAN BE USED IN HEATED CARTS OR UNDER HEAT LAMPS UP TO 212 DEGREES F. AC-1991 IS NSF LISTED. SOLD ONLY IN QUANTITIES OF 12 - PRICE SHOWN IS PER EACH.

- |         |                                 |                  |        |
|---------|---------------------------------|------------------|--------|
| AC-1987 | FIT 8.69" TO 9.13" DIA. PLATE   | <b>CASE PACK</b> | 1 DOZ. |
| AC-1988 | FIT 9.44" TO 9.75" DIA. PLATE   |                  | 1 DOZ. |
| AC-1989 | FIT 9.81" TO 10" DIA. PLATE     |                  | 1 DOZ. |
| AC-1990 | FIT 10.81" TO 10.25" DIA. PLATE |                  | 1 DOZ. |
| AC-1991 | FIT 10.5" TO 10.63" DIA. PLATE  |                  | 1 DOZ. |
| AC-1992 | FIT 10.75" TO 11" DIA. PLATE    |                  | 1 DOZ. |
| AC-1993 | FIT 12" DIA. PLATE              |                  | 1 DOZ. |



**PLATE COVER CART**

HOLDS UP TO 175 COVERS.

PCCT-550  
40 1/2" H. X 20" DIA.

**ROUND**



**OVAL**



**RECTANGULAR**



**TRIANGULAR**



**SQUARE**



**PLATE COVER (POLYCARBONATE)**  
COMMERCIAL DISHWASHER SAFE. BREAK-RESISTANT MELAMINE. SOLD IN CASE PACKS OF ONE DOZEN ONLY!

**QUICK SHIP!**

- |         |  |                  |        |
|---------|--|------------------|--------|
| AC-2190 | FOR 8.25" - 9" ROUND PLATE                   | <b>CASE PACK</b> | 1 DOZ. |
| AC-2191 | FOR 8.63" - 9.25" ROUND PLATE                |                  | 1 DOZ. |
| AC-2192 | FOR 8.8" - 9.63" ROUND PLATE                 |                  | 1 DOZ. |
| AC-2193 | FOR 9.7" - 10.4" ROUND PLATE                 |                  | 1 DOZ. |
| AC-2194 | FOR 9.25" - 10" ROUND PLATE                  |                  | 1 DOZ. |
| AC-2195 | FOR 10.4" - 11.15" ROUND PLATE               |                  | 1 DOZ. |
| AC-2196 | FOR 8" x 11.25" - 8.63" x 11.94" OVAL PLATE  |                  | 1 DOZ. |
| AC-2197 | FOR 11.13" x 13" - 11.6" x 13.5" RECT. PLATE |                  | 1 DOZ. |
| AC-2198 | FOR 11.6" - 12.25" TRIANGULAR PLATE          |                  | 1 DOZ. |
| AC-2199 | FOR 11" - 11.8" SQUARE PLATE                 |                  | 1 DOZ. |
| AC-2200 | FOR 7.9" - 8.8" ROUND PLATE                  |                  | 1 DOZ. |
| AC-2201 | FOR 10.6" - 11.4" ROUND PLATE                |                  | 1 DOZ. |
| AC-2202 | FOR 11.25" - 12" ROUND PLATE                 |                  | 1 DOZ. |
| AC-2203 | FOR 10.75" - 11.8" ROUND PLATE               |                  | 1 DOZ. |
| AC-2204 | FOR 12" TRIANGULAR PLATE                     |                  | 1 DOZ. |
| AC-2205 | FOR 11.4" - 12" ROUND PLATE                  |                  | 1 DOZ. |

**QUICK SHIP!**

**SILVER**



**AMBER**



**BEIGE**



**CLEAR**



**PLATE COVERS (POLYCARBONATE)**

PLATE COVER AVAILABLE IN CLEAR (152), AMBER (153), BEIGE (133), SILVER (486). PLEASE SPECIFY COLOR WHEN ORDERING MUST BE ORDERED IN CASE PACKS OF ONE DOZEN ONLY!

- |          |                              |                  |        |
|----------|------------------------------|------------------|--------|
| AC-46400 | 8 7/16" DIA x 2 11/16" H.    | <b>CASE PACK</b> | 1 DOZ. |
| AC-46401 | 9 1/8" DIA. x 2 3/4" H.      |                  | 1 DOZ. |
| AC-46402 | 9 5/16" DIA. x 2 13/16" H.   |                  | 1 DOZ. |
| AC-46403 | 9 1/2" DIA. x 2 13/16" H.    |                  | 1 DOZ. |
| AC-46404 | 9 3/4" DIA. x 2 3/4" H.      |                  | 1 DOZ. |
| AC-46405 | 10" DIA. x 2 7/8" H.         |                  | 1 DOZ. |
| AC-46406 | 10" DIA. x 2 3/4" H.         |                  | 1 DOZ. |
| AC-46407 | 10 3/16" DIA. x 2 11/16" H.  |                  | 1 DOZ. |
| AC-46408 | 10 9/16" DIA. x 2 13/16" H.  |                  | 1 DOZ. |
| AC-46409 | 10 5/8" DIA. x 2 3/4" H.     |                  | 1 DOZ. |
| AC-46410 | 10 13/16" DIA. x 2 11/16" H. |                  | 1 DOZ. |
| AC-46411 | 11" DIA. x 2 11/16" H.,      |                  | 1 DOZ. |
| AC-46412 | 12 1/8" DIA. x 2 3/4" H.     |                  | 1 DOZ. |



**CUSTOM OVAL STAINLESS PLATE COVERS**

THEY ARE BRIGHT FINISH ON THE SIDES AND SATIN FINISH ON THE TOP. THE MINIMUM ORDER IS 24 COVERS PER SIZE.

- AC-19352 PLATE COVER FOR OVAL PLATE 9 1/2" TO 11" L.
- AC-19353 PLATE COVER FOR OVAL PLATE 11 1/6" TO 12 1/2" L.
- AC-19354 PLATE COVER FOR OVAL PLATE 11 3/8" TO 13" L.
- AC-19355 PLATE COVER FOR OVAL PLATE 12 5/8" TO 15 1/2" L.
- AC-19356 PLATE COVER FOR OVAL PLATE 13" TO 16" L.

**NEW!**



**SAFE-STACK PLATE COVERS (CLEAR POLYCARBONATE)**

DISHWASHER SAFE UP TO 200°F AND SOLD IN CASE PACKS OF 12.

- AC-91880 PLATE COVER FOR PLATES 8 1/2" - 9 1/8" DIA., 2 5/8" H.
- AC-91881 PLATE COVER FOR PLATES 9 1/8" - 9 5/8" DIA., 2 5/8" H.
- AC-91882 PLATE COVER FOR PLATES 9 1/8" - 9 5/8" DIA., 2 5/8" H.
- AC-91883 PLATE COVER FOR PLATES 9 7/8" - 10 1/8" DIA., 2 3/4" H.
- AC-91884 PLATE COVER FOR PLATES 10 1/8" - 10 3/8" DIA., 2 3/4" H.
- AC-91885 PLATE COVER FOR PLATES 10 1/2" - 10 5/8" DIA., 2 3/4" H.
- AC-91886 PLATE COVER FOR PLATE 11" DIA., 2 7/8" H.
- AC-91887 PLATE COVER FOR PLATE 12" DIA., 2 7/8" H.

# WAREWASHING RACKS

## TRAEX® FULL SIZE COMPARTMENT RACK

TRAEX® FULL-SIZE RACK MAX® COMPARTMENT RACKS ARE DESIGNED TO HOLD 17-30% MORE GLASSWARE THAN A TRADITIONAL RACK. SMALL SIDE COMPARTMENTS HOLD FLATWARE, SALT SHAKERS, RAMEKINS, ETC.

- OPEN PROFILE ALLOWS TOP-TO-BOTTOM AND SIDE-TO-SIDE THOROUGH WASHING AND AIR CIRCULATION
- BUILT IN BASE RACK DIVIDERS PROVIDE 100% VERTICAL PROTECTION
- SNAP FIT EXTENDERS WILL NOT LOOSEN OVER TIME OR COME APART
- CO-POLYMER PLASTIC GIVES RACKS CHEMICAL, IMPACT AND HEAT RESISTANCE - SAFE UP TO 180 F° FOR 30 MINUTES
- OUTSIDE DIMENSIONS: 19 3/4" X 19 3/4"
- COMPARTMENT SIZE DIMENSIONS SHOWN BELOW

**\*ALL TRAEX® RACKS ARE MADE TO ORDER. CAN'T BE CHANGED, CANCELLED, OR RETURNED ONCE ORDERED.**

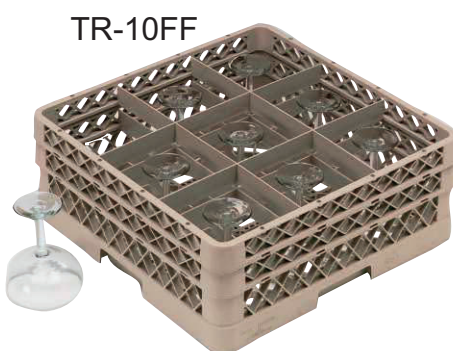

TR-10FF

## TRAEX® FULL SIZE 9 COMPARTMENT SQUARE RACKS

ITEM NUMBER	DESCRIPTION	OVERALL DIMENSIONS	COMPARTMENT SIZE	COMPARTMENT HEIGHT	CASE PACK
*TR-13F	LOW PROFILE BASE RACK W/ ONE EXTENDER	19 3/4" X 19 3/4" X 2 7/8"	5 7/8" SQUARE	2 1/16"	2 EA.
*TR-10	RACK BASE	19 3/4" X 19 3/4" X 4"	5 7/8" SQUARE	3 1/4"	6 EA.
*TR-13FF	LOW PROFILE BASE RACK W/ TWO EXTENDERS	19 3/4" X 19 3/4" X 4 1/2"	5 7/8" SQUARE	3 9/16"	2 EA.
*TR-10F	RACK BASE W/ ONE EXTENDER	19 3/4" X 19 3/4" X 5 9/16"	5 7/8" SQUARE	4 13/16"	2 EA.
*TR-10A	RACK BASE W/ ONE OPEN EXTENDER	19 3/4" X 19 3/4" X 5 9/16"	5 7/8" SQUARE	4 13/16"	2 EA.
*TR-13FFF	LOW PROFILE BASE RACK W/ THREE EXTENDERS	19 3/4" X 19 3/4" X 6 1/8"	5 7/8" SQUARE	5 1/8"	2 EA.
*TR-10FF	RACK BASE W/ TWO EXTENDERS	19 3/4" X 19 3/4" X 7 1/8"	5 7/8" SQUARE	6 3/8"	2 EA.
*TR-13FFFF	LOW PROFILE BASE RACK W/ FOUR EXTENDERS	19 3/4" X 19 3/4" X 7 5/8"	5 7/8" SQUARE	6 3/4"	2 EA.
*TR-10FFF	RACK BASE W/ THREE EXTENDERS	19 3/4" X 19 3/4" X 8 3/4"	5 7/8" SQUARE	7 7/8"	2 EA.
*TR-10FFFF	RACK BASE W/ FOUR EXTENDERS	19 3/4" X 19 3/4" X 10 5/16"	5 7/8" SQUARE	9 7/16"	2 EA.
*TR-10FFFA	RACK BASE W/ THREE EXTENDERS AND ONE OPEN EXTENDER	19 3/4" X 19 3/4" X 10 5/16"	5 7/8" SQUARE	9 7/16"	2 EA.
*TR-10FFFFF	RACK BASE W/ FIVE EXTENDERS	19 3/4" X 19 3/4" X 11 7/8"	5 7/8" SQUARE	11"	2 EA.
*TR-10FFFFFA	RACK BASE W/ FOUR EXTENDERS AND ONE OPEN EXTENDER	19 3/4" X 19 3/4" X 11 7/8"	5 7/8" SQUARE	11"	2 EA.



TR-18JJ

THIS HEXAGON DESIGN REDUCES GLASS BREAKAGE THROUGH BUILT IN BASE RACK DIVIDERS THAT PROVIDE 100% VERTICAL GLASSWARE PROTECTION. THE DOUBLE-WALL DESIGN ABSORBS THE IMPACT OF THE MOVING RACK ELIMINATING BROKEN GLASSES, AND REINFORCED INDEX STRIPS WITHSTAND THE ABUSE OF CONVEYOR DISHWASHING MACHINES.

## TRAEX® FULL SIZE RACK MAX® 12 COMPARTMENT HEXAGON RACKS

ITEM NUMBER	DESCRIPTION	OVERALL DIMENSIONS	COMPARTMENT SIZE	COMPARTMENT HEIGHT	CASE PACK
*TR-13J	LOW PROFILE BASE RACK W/ ONE EXTENDER	19 3/4" X 19 3/4" X 2 7/8"	4 3/4" HEXAGON	2 1/16"	2 EA.
*TR-18	BASE RACK	19 3/4" X 19 3/4" X 4"	4 3/4" HEXAGON	3 1/4"	6 EA.
*TR-13JJ	LOW PROFILE BASE RACK W/ TWO EXTENDERS	19 3/4" X 19 3/4" X 7 1/8"	4 3/4" HEXAGON	6 3/8"	2 EA.
*TR-18J	BASE RACK W/ TWO EXTENDERS	19 3/4" X 19 3/4" X 5 9/16"	4 3/4" HEXAGON	4 13/16"	2 EA.
*TR-18A	BASE RACK W/AN OPEN RACK EXTENDER ON TOP	19 3/4" X 19 3/4" X 5 9/16"	4 3/4" HEXAGON	4 13/16"	2 EA.
*TR-13JJJ	LOW PROFILE BASE RACK W/ THREE EXTENDERS	19 3/4" X 19 3/4" X 6 1/8"	4 3/4" HEXAGON	5 1/8"	2 EA.
*TR-18JJ	BASE RACK W/ TWO EXTENDERS	19 3/4" X 19 3/4" X 7 1/8"	4 3/4" HEXAGON	6 3/8"	2 EA.
*TR-18JA	BASE RACK W/ ONE EXTENDER AND AN OPEN RACK EXTENDER ON TOP	19 3/4" X 19 3/4" X 7 1/8"	4 3/4" HEXAGON	6 3/8"	2 EA.
*TR-13JJJJ	LOW PROFILE BASE RACK W/ FOUR EXTENDERS	19 3/4" X 19 3/4" X 7 5/8"	4 3/4" HEXAGON	6 3/4"	2 EA.
*TR-18JJJ	BASE RACK W/ THREE EXTENDERS	19 3/4" X 19 3/4" X 8 3/4"	4 3/4" HEXAGON	7 7/8"	2 EA.
*TR-18JJA	BASE RACK W/ TWO EXTENDERS AND AN OPEN RACK EXTENDER ON TOP	19 3/4" X 19 3/4" X 8 3/4"	4 3/4" HEXAGON	7 7/8"	2 EA.
*TR-18JJJJ	BASE RACK W/ FOUR EXTENDERS	19 3/4" X 19 3/4" X 10 5/16"	4 3/4" HEXAGON	9 7/16"	2 EA.
*TR-18JJJJ	BASE RACK W/ THREE EXTENDERS & AN OPEN RACK EXTENDER ON TOP	19 3/4" X 19 3/4" X 10 5/16"	4 3/4" HEXAGON	9 7/16"	2 EA.
*TR-18JJJJJ	BASE RACK W/ FIVE EXTENDERS	19 3/4" X 19 3/4" X 11 7/8"	4 3/4" HEXAGON	11"	2 EA.
*TR-18JJJJJA	BASE RACK W/ FOUR EXTENDERS & AN OPEN RACK EXTENDER ON TOP	19 3/4" X 19 3/4" X 11 7/8"	4 3/4" HEXAGON	11"	2 EA.

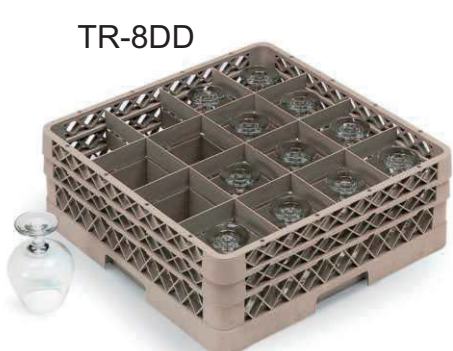

TR-8DD

## TRAEX® FULL SIZE 16 COMPARTMENT SQUARE RACKS

ITEM NUMBER	DESCRIPTION	OVERALL DIMENSIONS	COMPARTMENT SIZE	COMPARTMENT HEIGHT	CASE PACK
*TR-13D	LOW PROFILE BASE RACK W/ ONE EXTENDER	19 3/4" X 19 3/4" X 2 7/8"	4 3/8" SQUARE	2 1/16"	2 EA.
*TR-8	RACK BASE	19 3/4" X 19 3/4" X 4"	4 3/8" SQUARE	3 1/4"	6 EA.
*TR-13DD	LOW PROFILE BASE RACK W/ TWO EXTENDERS	19 3/4" X 19 3/4" X 4 1/2"	4 3/8" SQUARE	3 9/16"	2 EA.
*TR-8D	RACK BASE W/ ONE EXTENDER	19 3/4" X 19 3/4" X 5 9/16"	4 3/8" SQUARE	4 3/8"	2 EA.
*TR-8A	RACK BASE W/ ONE OPEN EXTENDER	19 3/4" X 19 3/4" X 5 9/16"	4 3/8" SQUARE	4 3/8"	2 EA.
*TR-13DDD	LOW PROFILE BASE RACK W/ THREE EXTENDERS	19 3/4" X 19 3/4" X 6 1/8"	4 3/8" SQUARE	5 1/8"	2 EA.
*TR-8DD	RACK BASE W/ TWO EXTENDERS	19 3/4" X 19 3/4" X 7 1/8"	4 3/8" SQUARE	6 3/8"	2 EA.
*TR-8DA	RACK BASE W/ ONE EXTENDER AND ONE OPEN EXTENDER	19 3/4" X 19 3/4" X 7 1/8"	4 3/8" SQUARE	6 3/8"	2 EA.
*TR-13DDDD	LOW PROFILE BASE RACK W/ FOUR EXTENDERS	19 3/4" X 19 3/4" X 7 5/8"	4 3/8" SQUARE	6 3/4"	2 EA.
*TR-8DDD	RACK BASE W/ THREE EXTENDERS	19 3/4" X 19 3/4" X 8 3/4"	4 3/8" SQUARE	7 7/8"	2 EA.
*TR-8DDDD	RACK BASE W/ FOUR EXTENDERS	19 3/4" X 19 3/4" X 10 5/16"	4 3/8" SQUARE	9 7/16"	2 EA.
*TR-8DDDDA	RACK BASE W/ THREE EXTENDERS AND ONE OPEN EXTENDER	19 3/4" X 19 3/4" X 10 5/16"	4 3/8" SQUARE	9 7/16"	2 EA.
*TR-8DDDDD	RACK BASE W/ FIVE EXTENDERS	19 3/4" X 19 3/4" X 11 7/8"	4 3/8" SQUARE	11"	2 EA.
*TR-8DDDDDA	RACK BASE W/ FOUR EXTENDERS AND ONE OPEN EXTENDER	19 3/4" X 19 3/4" X 11 7/8"	4 3/8" SQUARE	11"	2 EA.

# WAREWASHING RACKS

TR-11GG



THIS HEXAGON DESIGN REDUCES GLASS BREAKAGE THROUGH BUILT IN BASE RACK DIVIDERS THAT PROVIDE 100% VERTICAL GLASSWARE PROTECTION. THE DOUBLE-WALL DESIGN ABSORBS THE IMPACT OF THE MOVING RACK ELIMINATING BROKEN GLASSES, AND REINFORCED INDEX STRIPS WITHSTAND THE ABUSE OF CONVEYOR DISHWASHING MACHINES.

## TRAEX® FULL SIZE RACK MAX® 20 COMPARTMENT HEXAGON RACKS

ITEM NUMBER	DESCRIPTION	OVERALL DIMENSIONS	COMPARTMENT SIZE	COMPARTMENT HEIGHT	CASE PACK
*TR-11	BASE RACK	19 3/4" X 19 3/4" X 4"	3 15/16" HEXAGON	3 1/4"	6 EA.
*TR-11G	BASE RACK W/ ONE EXTENDER	19 3/4" X 19 3/4" X 5 9/16"	3 15/16" HEXAGON	4 13/16"	2 EA.
*TR-11A	BASE RACK W/AN OPEN RACK EXTENDER ON TOP	19 3/4" X 19 3/4" X 5 9/16"	3 15/16" HEXAGON	4 13/16"	2 EA.
*TR-11GG	BASE RACK W/ TWO EXTENDERS	19 3/4" X 19 3/4" X 7 1/8"	3 15/16" HEXAGON	6 3/8"	2 EA.
*TR-11GA	BASE RACK W/ ONE EXTENDER AND AN OPEN RACK EXTENDER ON TOP	19 3/4" X 19 3/4" X 7 1/8"	3 15/16" HEXAGON	6 3/8"	2 EA.
*TR-11GGG	BASE RACK W/ THREE EXTENDERS	19 3/4" X 19 3/4" X 8 3/4"	3 15/16" HEXAGON	7 7/8"	2 EA.
*TR-11GGA	BASE RACK W/ TWO EXTENDERS & AN OPEN RACK EXTENDER ON TOP	19 3/4" X 19 3/4" X 8 3/4"	3 15/16" HEXAGON	7 7/8"	2 EA.
*TR-11GGGG	BASE RACK W/ FOUR EXTENDERS	19 3/4" X 19 3/4" X 10 5/16"	3 15/16" HEXAGON	9 7/16"	2 EA.
*TR-11GGGA	BASE RACK W/ THREE EXTENDERS & AN OPEN RACK EXTENDER ON TOP	19 3/4" X 19 3/4" X 10 5/16"	3 15/16" HEXAGON	9 7/16"	2 EA.

**\*ALL TRAEX® RACKS ARE MADE TO ORDER. CAN'T BE CHANGED, CANCELLED, OR RETURNED ONCE ORDERED.**

TR-6BB



## TRAEX® FULL SIZE 25 COMPARTMENT SQUARE RACKS

ITEM NUMBER	DESCRIPTION	OVERALL DIMENSIONS	COMPARTMENT SIZE	COMPARTMENT HEIGHT	CASE PACK
*TR-13B	LOW PROFILE BASE RACK W / ONE EXTENDER	19 3/4" X 19 3/4" X 2 7/8"	3 1/2" SQUARE	2 1/16"	2 EA.
*TR-6	RACK BASE	19 3/4" X 19 3/4" X 4"	3 1/2" SQUARE	3 1/4"	6 EA.
*TR-13BB	LOW PROFILE BASE RACK W/ TWO EXTENDERS	19 3/4" X 19 3/4" X 4 1/2"	3 1/2" SQUARE	3 9/16"	2 EA.
*TR-6B	RACK BASE W/ ONE EXTENDER	19 3/4" X 19 3/4" X 5 9/16"	3 1/2" SQUARE	4 13/16"	2 EA.
*TR-6A	RACK BASE W/ ONE OPEN EXTENDER	19 3/4" X 19 3/4" X 5 9/16"	3 1/2" SQUARE	4 13/16"	2 EA.
*TR-6BB	RACK BASE W/ TWO EXTENDERS	19 3/4" X 19 3/4" X 7 1/8"	3 1/2" SQUARE	6 3/8"	2 EA.
*TR-6BA	RACK BASE W/ ONE EXTENDER AND ONE OPEN EXTENDER	19 3/4" X 19 3/4" X 7 1/8"	3 1/2" SQUARE	6 3/8"	2 EA.
*TR-6BBB	RACK BASE W/ THREE EXTENDERS	19 3/4" X 19 3/4" X 8 3/4"	3 1/2" SQUARE	7 7/8"	2 EA.
*TR-6BBBB	RACK BASE W/ FOUR EXTENDERS	19 3/4" X 19 3/4" X 10 5/16"	3 1/2" SQUARE	9 7/16"	2 EA.
*TR-6BBBA	RACK BASE W/ THREE EXTENDERS AND ONE OPEN EXTENDER	19 3/4" X 19 3/4" X 10 5/16"	3 1/2" SQUARE	9 7/16"	2 EA.
*TR-6BBBBA	RACK BASE W/ FOUR EXTENDERS AND ONE OPEN EXTENDER	19 3/4" X 19 3/4" X 11 7/8"	3 1/2" SQUARE	11"	2 EA.

TR-12HH

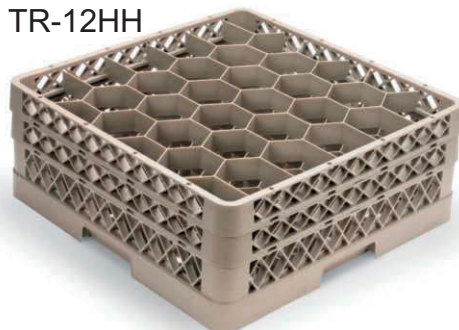

THIS HEXAGON DESIGN REDUCES GLASS BREAKAGE THROUGH BUILT IN BASE RACK DIVIDERS THAT PROVIDE 100% VERTICAL GLASSWARE PROTECTION. THE DOUBLE-WALL DESIGN ABSORBS THE IMPACT OF THE MOVING RACK ELIMINATING BROKEN GLASSES, AND REINFORCED INDEX STRIPS WITHSTAND THE ABUSE OF CONVEYOR DISHWASHING MACHINES.

## TRAEX® FULL SIZE RACK MAX® 30 COMPARTMENT HEXAGON RACKS

ITEM NUMBER	DESCRIPTION	OVERALL DIMENSIONS	COMPARTMENT SIZE	COMPARTMENT HEIGHT	CASE PACK
*TR-13H	LOW PROFILE BASE RACK W/ ONE EXTENDER	19 3/4" X 19 3/4" X 2 7/8"	3 3/16" HEXAGON	2 1/16"	2 EA.
*TR-12	BASE RACK	19 3/4" X 19 3/4" X 4"	3 3/16" HEXAGON	3 1/4"	6 EA.
*TR-13HH	LOW PROFILE BASE RACK W/ TWO EXTENDERS	19 3/4" X 19 3/4" X 4 1/2"	3 3/16" HEXAGON	3 9/16"	2 EA.
*TR-12H	BASE RACK W/ ONE EXTENDER	19 3/4" X 19 3/4" X 5 9/16"	3 3/16" HEXAGON	4 13/16"	2 EA.
*TR-12A	BASE RACK W/AN OPEN RACK EXTENDER ON TOP	19 3/4" X 19 3/4" X 5 9/16"	3 3/16" HEXAGON	4 13/16"	2 EA.
*TR-13HHH	LOW PROFILE BASE RACK W/ THREE EXTENDERS	19 3/4" X 19 3/4" X 6 1/8"	3 3/16" HEXAGON	5 1/8"	2 EA.
*TR-12HH	BASE RACK W/ TWO EXTENDERS	19 3/4" X 19 3/4" X 7 1/8"	3 3/16" HEXAGON	6 3/8"	2 EA.
*TR-12HA	BASE RACK W/ ONE EXTENDER & AN OPEN RACK EXTENDER ON TOP	19 3/4" X 19 3/4" X 7 1/8"	3 3/16" HEXAGON	6 3/8"	2 EA.
*TR-13HHHH	LOW PROFILE BASE RACK W/ FOUR EXTENDERS	19 3/4" X 19 3/4" X 7 5/8"	3 3/16" HEXAGON	6 3/4"	2 EA.
*TR-12HHH	BASE RACK W/ THREE EXTENDERS	19 3/4" X 19 3/4" X 8 3/4"	3 3/16" HEXAGON	7 7/8"	2 EA.
*TR-12HHA	BASE RACK W/ TWO EXTENDERS & AN OPEN RACK EXTENDER ON TOP	19 3/4" X 19 3/4" X 8 3/4"	3 3/16" HEXAGON	7 7/8"	2 EA.
*TR-12HHHH	BASE RACK W/ FOUR EXTENDERS	19 3/4" X 19 3/4" X 10 5/16"	3 3/16" HEXAGON	9 7/16"	2 EA.
*TR-12HHHA	BASE RACK W/THREE EXTENDERS & AN OPEN RACK EXTENDER ON TOP	19 3/4" X 19 3/4" X 10 5/16"	3 3/16" HEXAGON	9 7/16"	2 EA.
*TR-12HHHHH	BASE RACK W/ FIVE EXTENDERS	19 3/4" X 19 3/4" X 11 7/8"	3 3/16" HEXAGON	11"	2 EA.
*TR-12HHHHA	BASE RACK W/ FOUR EXTENDERS & AN OPEN RACK EXTENDER ON TOP	19 3/4" X 19 3/4" X 11 7/8"	3 3/16" HEXAGON	11"	2 EA.

TR-7CCC



## TRAEX® FULL SIZE 36 COMPARTMENT SQUARE RACKS

ITEM NUMBER	DESCRIPTION	OVERALL DIMENSIONS	COMPARTMENT SIZE	COMPARTMENT HEIGHT	CASE PACK
*TR-13C	LOW PROFILE BASE RACK W/ ONE EXTENDER	19 3/4" X 19 3/4" X 2 7/8"	2 7/8" SQUARE	2 1/16"	2 EA.
*TR-7	RACK BASE	19 3/4" X 19 3/4" X 4"	2 7/8" SQUARE	3 1/4"	6 EA.
*TR-13CC	LOW PROFILE BASE RACK W/ TWO EXTENDERS	19 3/4" X 19 3/4" X 4 1/2"	2 7/8" SQUARE	3 9/16"	2 EA.
*TR-7C	RACK BASE W/ ONE EXTENDER	19 3/4" X 19 3/4" X 5 9/16"	2 7/8" SQUARE	4 13/16"	2 EA.
*TR-7A	RACK BASE W/ ONE OPEN EXTENDER	19 3/4" X 19 3/4" X 5 9/16"	2 7/8" SQUARE	4 13/16"	2 EA.
*TR-13CCC	LOW PROFILE BASE RACK W/ THREE EXTENDERS	19 3/4" X 19 3/4" X 6 1/8"	2 7/8" SQUARE	5 1/8"	2 EA.
*TR-7CC	RACK BASE W/ TWO EXTENDERS	19 3/4" X 19 3/4" X 7 1/8"	2 7/8" SQUARE	6 3/8"	2 EA.
*TR-7CA	RACK BASE W/ ONE EXTENDER AND ONE OPEN EXTENDER	19 3/4" X 19 3/4" X 7 1/8"	2 7/8" SQUARE	6 3/8"	2 EA.
*TR-13CCCC	LOW PROFILE BASE RACK W/ FOUR EXTENDERS	19 3/4" X 19 3/4" X 7 5/8"	2 7/8" SQUARE	6 3/4"	2 EA.
*TR-7CCC	RACK BASE W/ THREE EXTENDERS	19 3/4" X 19 3/4" X 8 3/4"	2 7/8" SQUARE	7 7/8"	2 EA.
*TR-7CCCC	RACK BASE W/ FOUR EXTENDERS	19 3/4" X 19 3/4" X 10 5/16"	2 7/8" SQUARE	9 7/16"	2 EA.
*TR-7CCCA	RACK BASE W/ THREE EXTENDERS AND ONE OPEN EXTENDER	19 3/4" X 19 3/4" X 10 5/16"	2 7/8" SQUARE	9 7/16"	2 EA.

# WAREWASHING RACKS

THIS HEXAGON DESIGN REDUCES GLASS BREAKAGE THROUGH BUILT IN BASE RACK DIVIDERS THAT PROVIDE 100% VERTICAL GLASSWARE PROTECTION. THE DOUBLE-WALL DESIGN ABSORBS THE IMPACT OF THE MOVING RACK ELIMINATING BROKEN GLASSES, AND REINFORCED INDEX STRIPS WITHSTAND THE ABUSE OF CONVEYOR DISHWASHING MACHINES.



TR-1700

## TRAEX® FULL SIZE RACK MAX® 42 COMPARTMENT HEXAGON RACKS

ITEM NUMBER	DESCRIPTION	OVERALL DIMENSIONS	COMPARTMENT SIZE	COMPARTMENT HEIGHT	CASE PACK
*TR-1600	LOW PROFILE BASE RACK W/ ONE EXTENDER	19 3/4" X 19 3/4" X 2 7/8"	2 3/4" HEXAGON	2 1/16"	2 EA.
*TR-1700	LOW PROFILE BASE RACK W/ TWO EXTENDERS	19 3/4" X 19 3/4" X 4 1/2"	2 3/4" HEXAGON	3 9/16"	2 EA.
*TR-1900	LOW PROFILE BASE RACK W/ THREE EXTENDERS	19 3/4" X 19 3/4" X 6 1/8"	2 3/4" HEXAGON	5 1/8"	2 EA.
*TR-2000	LOW PROFILE BASE RACK W/ FOUR EXTENDERS	19 3/4" X 19 3/4" X 7 5/8"	2 3/4" HEXAGON	6 3/4"	2 EA.



TR-9EA

## TRAEX® FULL SIZE 49 COMPARTMENT SQUARE RACKS

ITEM NUMBER	DESCRIPTION	OVERALL DIMENSIONS	COMPARTMENT SIZE	COMPARTMENT HEIGHT	CASE PACK
*TR-9	RACK BASE	19 3/4" X 19 3/4" X 4"	2 7/16" SQUARE	3 1/4"	6 EA.
*TR-9E	RACK BASE W/ ONE EXTENDER	19 3/4" X 19 3/4" X 5 9/16"	2 7/16" SQUARE	4 13/16"	2 EA.
*TR-9A	RACK BASE W/ ONE OPEN EXTENDER	19 3/4" X 19 3/4" X 5 9/16"	2 7/16" SQUARE	4 13/16"	2 EA.
*TR-9EE	RACK BASE W/ TWO EXTENDERS	19 3/4" X 19 3/4" X 7 1/8"	2 7/16" SQUARE	6 3/8"	2 EA.
*TR-9EA	RACK BASE W/ ONE EXTENDER AND ONE OPEN EXTENDER	19 3/4" X 19 3/4" X 7 1/8"	2 7/16" SQUARE	6 3/8"	2 EA.
*TR-9EEE	RACK BASE W/ THREE EXTENDERS	19 3/4" X 19 3/4" X 8 3/4"	2 7/16" SQUARE	7 7/8"	2 EA.
*TR-9EEA	RACK BASE W/ TWO EXTENDERS AND ONE OPEN EXTENDER	19 3/4" X 19 3/4" X 8 3/4"	2 7/16" SQUARE	7 7/8"	2 EA.

## TRAEX® FULL SIZE CUP RACK

- MOLDED IN TILT BAR PREVENTS WATER FROM POOLING, LEAVING SPOT FREE GLASSWARE
- TR-4 AND TR-5 HAVE A 3" HIGH COMPARTMENT DIVIDERS FOR VERTICAL PROTECTION
- OUTSIDE DIMENSIONS: 19 3/4" X 19 3/4"
- TR-16 IS IDEAL FOR ESPRESSO CUPS WITH THE 1" HIGH COMPARTMENT DIVIDE

**\*ALL TRAEX® RACKS ARE MADE TO ORDER. CAN'T BE CHANGED, CANCELLED, OR RETURNED ONCE ORDERED.**

## TRAEX® FULL SIZE 16 COMPARTMENT CUP RACKS



TR-4

ITEM NUMBER	DESCRIPTION	OVERALL DIMENSIONS	COMPARTMENT SIZE	COMPARTMENT HEIGHT	CASE PACK
*TR-4	CUP RACK BASE	19 3/4" X 19 3/4" X 4"	4 7/16" SQUARE	3"	6 EA.
*TR-4D	CUP RACK BASE W/ ONE EXTENDER	19 3/4" X 19 3/4" X 4 13/16"	4 7/16" SQUARE	4 13/16"	2 EA.
*TR-4A	CUP RACK BASE W/ ONE LIP EXTENDER	19 3/4" X 19 3/4" X 5 9/16"	4 7/16" SQUARE	4 13/16"	2 EA.
*TR-4DD	CUP RACK BASE W/ TWO EXTENDERS	19 3/4" X 19 3/4" X 7 1/8"	4 7/16" SQUARE	6 3/8"	2 EA.
*TR-4DA	CUP RACK BASE W/ ONE EXTENDER AND ONE LIP EXTENDER	19 3/4" X 19 3/4" X 7 1/8"	4 7/16" SQUARE	6 3/8"	2 EA.
*TR-4DDD	CUP RACK BASE W/ THREE EXTENDERS	19 3/4" X 19 3/4" X 8 3/4"	4 7/16" SQUARE	7 7/8"	2 EA.
*TR-4DDA	CUP RACK BASE W/ TWO EXTENDERS AND ONE LIP EXTENDER	19 3/4" X 19 3/4" X 8 3/4"	4 7/16" SQUARE	7 7/8"	2 EA.
*TR-4DDDD	CUP RACK BASE W/ FOUR EXTENDERS	19 3/4" X 19 3/4" X 10 5/16"	4 7/16" SQUARE	9 7/16"	2 EA.
*TR-4DDDA	CUP RACK BASE W/ THREE EXTENDERS AND ONE LIP EXTENDER	19 3/4" X 19 3/4" X 10 5/16"	4 7/16" SQUARE	9 7/16"	2 EA.



TR-5

## TRAEX® FULL SIZE 20 COMPARTMENT CUP RACKS

ITEM NUMBER	DESCRIPTION	OVERALL DIMENSIONS	COMPARTMENT SIZE	COMPARTMENT HEIGHT	CASE PACK
*TR-5	CUP RACK BASE	19 3/4" X 19 3/4" X 4"	3 17/32" X 4 7/16"	3"	6 EA.
*TR-5A	CUP RACK BASE W/ ONE LIP EXTENDER	19 3/4" X 19 3/4" X 5 9/16"	3 17/32" X 4 7/16"	4 13/16"	2 EA.
*TR-5AA	CUP RACK BASE W/ TWO LIP EXTENDERS	19 3/4" X 19 3/4" X 7 1/8"	3 17/32" X 4 7/16"	6 3/8"	2 EA.



TR-16

## TRAEX® FULL SIZE 25 COMPARTMENT SQUARE RACKS

ITEM NUMBER	DESCRIPTION	OVERALL DIMENSIONS	COMPARTMENT SIZE	COMPARTMENT HEIGHT	CASE PACK
*TR-16	CUP RACK BASE	19 3/4" X 19 3/4" X 4"	3 17/32" SQUARE	3"	6 EA.
*TR-16B	CUP RACK BASE W/ ONE EXTENDER	19 3/4" X 19 3/4" X 5 9/16"	3 17/32" SQUARE	4 3/8"	2 EA.
*TR-16BB	CUP RACK BASE W/ TWO EXTENDERS	19 3/4" X 19 3/4" X 7 1/8"	3 17/32" SQUARE	5 5/8"	2 EA.
*TR-16BBB	CUP RACK BASE W/ THREE EXTENDERS	19 3/4" X 19 3/4" X 8 3/4"	3 17/32" SQUARE	7 3/8"	2 EA.
*TR-16BBBB	CUP RACK BASE W/ FOUR EXTENDERS	19 3/4" X 19 3/4" X 10 5/16"	3 17/32" SQUARE	8 15/16"	2 EA.

# WAREWASHING RACKS

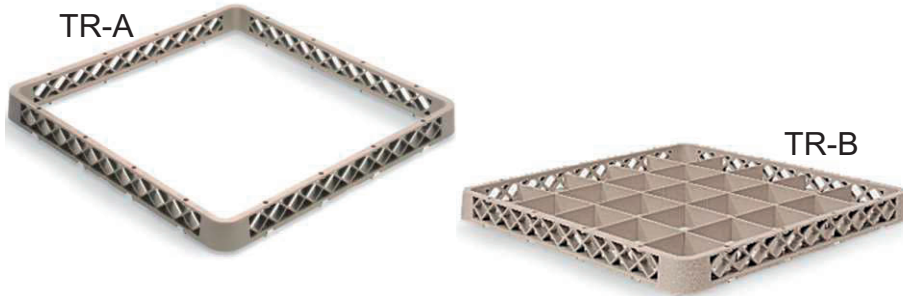

## TRAEX® RACK MASTER® FULL SIZE GLASS & CUP EXTENDERS

ITEM NUMBER	DESCRIPTION	OVERALL DIMENSIONS	COMPARTMENT SIZE	INSIDE HEIGHT	CASE PACK
*TR-A	OPEN EXTENDER	19 3/4" X 19 3/4" X 1 9/16"	18 1/16" SQ.	1 9/16"	12 EA.
*TR-B	25 COMPARTMENT EXTENDER	19 3/4" X 19 3/4" X 1 9/16"	3 17/32" SQ.	1 9/16"	12 EA.
*TR-C	36 COMPARTMENT EXTENDER	19 3/4" X 19 3/4" X 1 9/16"	2 15/16" SQ.	1 9/16"	12 EA.
*TR-D	16 COMPARTMENT EXTENDER	19 3/4" X 19 3/4" X 1 9/16"	4 17/16" SQ.	1 9/16"	12 EA.
*TR-E	49 COMPARTMENT EXTENDER	19 3/4" X 19 3/4" X 1 9/16"	2 1/2" SQ.	1 9/16"	12 EA.
*TR-F	9 COMPARTMENT EXTENDER	19 3/4" X 19 3/4" X 1 9/16"	6" SQ.	1 9/16"	12 EA.

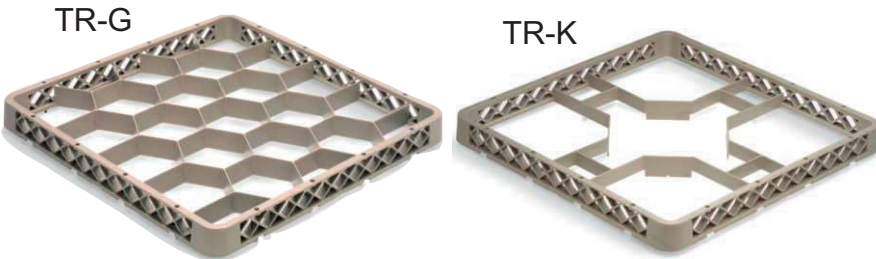

## TRAEX® RACK MAX® FULL SIZE GLASS & CUP EXTENDERS

ITEM NUMBER	DESCRIPTION	OVERALL DIMENSIONS	COMPARTMENT SIZE	INSIDE HEIGHT	CASE PACK
*TR-G	20 COMPARTMENT EXTENDER	19 3/4" X 19 3/4" X 1 9/16"	3 15/16" HEXAGON	1 9/16"	12 EA.
*TR-H	30 COMPARTMENT EXTENDER	19 3/4" X 19 3/4" X 1 9/16"	3 15/16" HEXAGON	1 9/16"	12 EA.
*TR-J	12 COMPARTMENT EXTENDER	19 3/4" X 19 3/4" X 1 9/16"	4 13/16" HEXAGON	1 9/16"	12 EA.
*TR-K	5 COMPARTMENT EXTENDER	19 3/4" X 19 3/4" X 1 9/16"	7 1/2"	1 9/16"	12 EA.
*TR-1500	42 COMPARTMENT EXTENDER	19 3/4" X 19 3/4" X 1 9/16"	2 3/4" HEXAGON	1 9/16"	12 EA.



- COMBINATION RACK FOR FLATWARE, CHINA, PITCHERS OR URNS
- CYLINDER SOLD SEPARATELY
- OUTSIDE DIMENSIONS: 19 3/4" X 19 3/4"

## TRAEX® COMBINATION RACK

ITEM NUMBER	DESCRIPTION	INSIDE COMPARTMENT	OVERALL HEIGHT	INSIDE HEIGHT	CASE PACK
*TR-15	COMBINATION RACK	18 1/16" X 18 1/16"	4"	3 1/4"	6 EA.

**\*ALL TRAEX® RACKS ARE MADE TO ORDER. CAN'T BE CHANGED, CANCELLED, OR RETURNED ONCE ORDERED.**



- IDEAL FOR SUPERSIZE GLASSWARE, PITCHERS, AND COFFEE URNS
- COMPARTMENT DIVIDERS PROVIDE COMPLETE VERTICAL PROTECTION
- OUTSIDE DIMENSIONS: 19 3/4" X 19 3/4"

## TRAEX® RACK MAX® PITCHER RACKS

ITEM NUMBER	DESCRIPTION	COMPARTMENT SIZE	OVERALL HEIGHT	INSIDE HEIGHT	CASE PACK
*TR-13Kkkkk	4 EXTENDERS	7 1/2"	7 5/8"	6 3/4"	2 EA.
*TR-13Kkkkkk	5 EXTENDERS	7 1/2"	9 3/16"	8 3/8"	2 EA.
*TR-13Kkkkkkk	6 EXTENDERS	7 1/2"	10 5/8"	10"	1 EA.

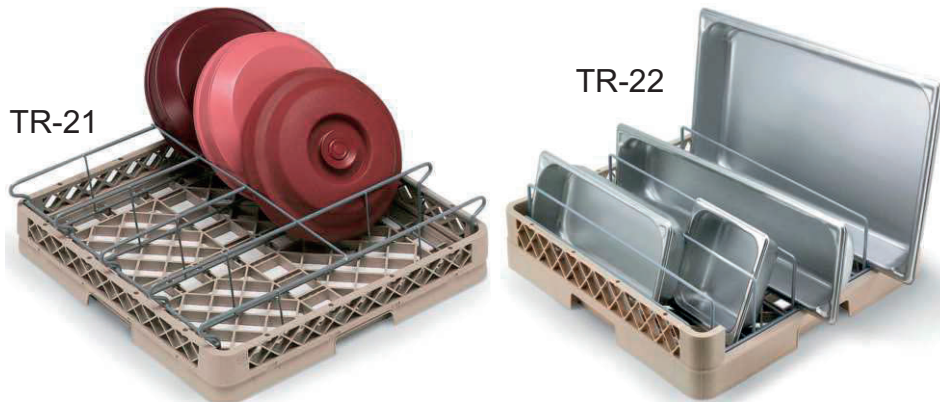

TR-21

TR-22

- TR-22 IS IDEAL FOR STEAM TABLE PANS, INSULATED TRAYS, AND PLATE COVERS
- SPACE BETWEEN DIVIDERS TR-22, 3"
- OUTSIDE DIMENSIONS: 19 3/4" X 19 3/4"

## TRAEX® INSULATED TRAY AND STEAM TABLE PAN TRAY RACKS

ITEM NUMBER	DESCRIPTION	OVERALL HEIGHT	INSIDE HEIGHT	CASE PACK
*TR-21	UP TO 9 3/4" PLATE COVER DIAMETER	4 3/4"	3 1/4"	1 EA.
*TR-22	OPEN END FOOD PAN AND INSULATED TRAY RACK	5 1/4"	5 1/4"	1 EA.
*TR-31	OPEN END RACK	5 1/4"	5 1/4"	1 EA.



- TR-23 HOLDS THREE FULL SIZE SHEET PANS
- TR31 HOLDS 7 TRAYS
- OUTSIDE DIMENSIONS: 19 3/4" X 19 3/4"

**\*ALL TRAEX® RACKS ARE MADE TO ORDER. CAN'T BE CHANGED, CANCELLED, OR RETURNED ONCE ORDERED.**

## TRAEX® FULL SIZE OPEN-END SHEET PAN RACKS

ITEM NUMBER	DESCRIPTION	OVERALL HEIGHT	INSIDE HEIGHT	CASE PACK
*TR-23	OPEN-END SHEET PAN RACK W/ VINYL COATED INSERT	4 3/4"	3 1/4"	1 EA.
*TR-31	OPEN END RACK	5 1/4"	5 1/4"	1 EA.



- FULL "BEAM WALL" PREVENTS RACK FROM FLEXING UNDER HEAVY LOADS
- IDEAL FOR WASHING TRAYS AND PANS
- COMPARTMENT SIZE: 18 1/16" SQ.
- OUTSIDE DIMENSIONS: 19 3/4" X 19 3/4"

## TRAEX® TRAY & PAN RACK

ITEM NUMBER	DESCRIPTION	OVERALL HEIGHT	INSIDE HEIGHT	CASE PACK
*TR-30	OPEN-ENDED PLATE AND TRAY RACK	4"	3 1/4"	6 EA.



# WAREWASHING RACKS



TR-3

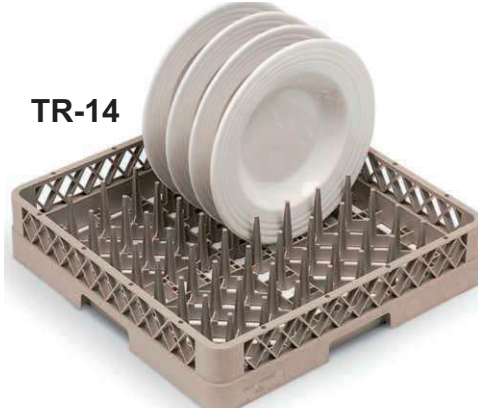

TR-14

- TR-3 HAS 9 ROWS X 9 ROWS AND 1 7/8" PEG SPACING
- TR-14 HAS 9 ROWS X 8 ROWS, 1 3/4" PEG SPACING
- EXTENDED PEG RACKS PREVENT LARGE PLATE BREAKAGE - ADDS 3" TO A STANDARD PEG RACK
- OUTSIDE DIMENSIONS: 19 3/4" X 19 3/4"

## TRAEX® FULL SIZE PLATE RACKS

ITEM NUMBER	DESCRIPTION	INSIDE COMPARTMENT	OVERALL HEIGHT	INSIDE HEIGHT	CASE PACK
*TR-3	PEG RACK	18 1/16" X 18 1/16"	4"	3 1/4"	6 EA.
*TR-14	HIGH EFFICIENCY PEG RACK	18 1/16" X 18 1/16"	4"	3 1/4"	6 EA.



TR-1



TR-13A

- TR-1 IS IDEAL FOR LARGE AND IRREGULARLY SHAPED ITEMS
- TR-13A LOW PROFILE RACK ALLOWS COMPACT AND EFFICIENT WASHINGS - PERFECT FOR STORING ITEMS LIKE RAMEKINS AND ASHTRAYS
- OUTSIDE DIMENSIONS: 19 3/4" X 19 3/4"

## TRAEX® FULL SIZE OPEN RACKS & EXTENDERS

ITEM NUMBER	DESCRIPTION	INSIDE COMPARTMENT	OVERALL HEIGHT	INSIDE HEIGHT	CASE PACK
*TR-1	OPEN RACK	18 1/16" X 18 1/16"	4"	3 1/4"	6 EA.
*TR-1A	OPEN RACK, 1 EXTENDER	18 1/16" X 18 1/16"	5 9/16"	4 13/16"	2 EA.
*TR-1AA	OPEN RACK, 2 EXTENDERS	18 1/16" X 18 1/16"	7 1/8"	6 3/8"	2 EA.
*TR-1AAAA	OPEN RACK, 4 EXTENDER	18 1/16" X 18 1/16"	6 1/4"	"	2 EA.
*TR-1AAAAA	OPEN RACK, 5 EXTENDER	18 1/16" X 18 1/16"	7 13/16"	"	2 EA.
*TR-1AAAAAA	OPEN RACK, 6 EXTENDER	18 1/16" X 18 1/16"	10 15/16"	"	2 EA.
*TR-13A	LOW PROFILE OPEN RACK/EXTENDER	18 1/16" X 18 1/16"	3"	2 1/4"	2 EA.

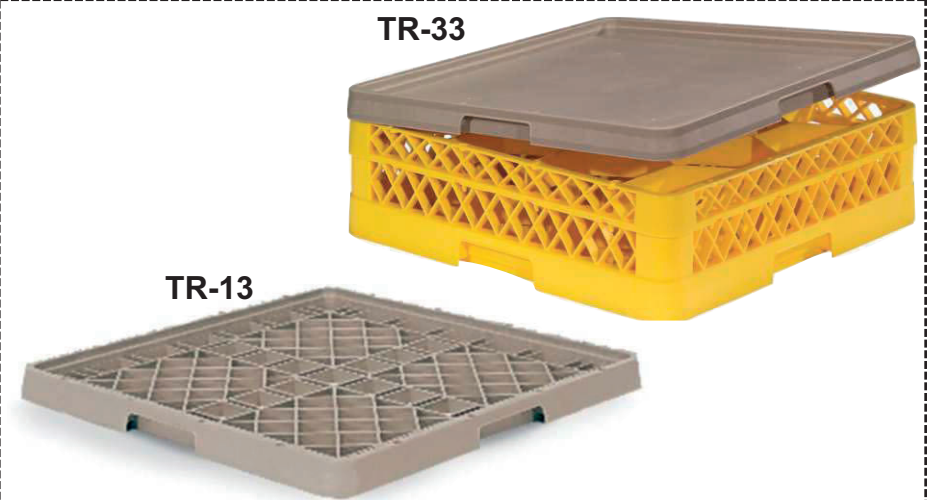

TR-33

TR-13

- OPEN DESIGN TOP PROMOTES BETTER WASHING AND LESS WATER POOLING
- SOLID COVER IDEAL FOR STORAGE
- COVERS FIT ALL VOLLRATH RACKS AND MOST MAJOR RACKS
- OUTSIDE DIMENSIONS: 19 3/4" X 19 3/4"

## TRAEX® RACK COVERS

ITEM NUMBER	DESCRIPTION	OUTSIDE DIMENSION	OVERALL HEIGHT	INSIDE HEIGHT	CASE PACK
*TR-13	COVER (LOW PROFILE RACK)	19 3/4" X 19 3/4"	1 7/16"	1/2"	6 EA.
*TR-33	SOLID RACK COVER	19 3/4" X 19 3/4"	1 7/16"	1/2"	6 EA.



**\*ALL TRAEX® RACKS ARE MADE TO ORDER. CAN'T BE CHANGED, CANCELLED, OR RETURNED ONCE ORDERED.**

•TRAEX® GRIDS HAVE VINYL COATING

## TRAEX® RACK WITH HOLD DOWN GRIDS

ITEM NUMBER	DESCRIPTION	SIZE	CASE PACK
*TR-2W	*TR-2 RACK WITH HOLD DOWN GRID (ASSEMBLED)	19 3/4" X 19 3/4"	1 EA.
*TR-13AW	TR13A RACK W/HOLD DOWN GRID (ASSEMBLED)	19 3/4" X 19 3/4"	1 EA.



- INTERIOR RIBS PREVENT KNIVES FROM PROTRUDING THROUGH THE SIDE WALLS
- MESH SURFACE KEEPS FLATWARE IN THE RACK
- OUTSIDE DIMENSIONS: 19 3/4" X 19 3/4"

## TRAEX® FULL SIZE FLATWARE RACK

ITEM NUMBER	DESCRIPTION	INSIDE COMPARTMENT	OVERALL HEIGHT	INSIDE HEIGHT	EACH PRICE	CASE PACK
*TR-2	FLATWARE RACK	18 1/16" X 18 1/16"	4"	3 1/4"	\$27.00 EA.	6 EA.



•GRAVITY-FED SYSTEM FILLS THE GLASSWARE IN SECONDS



## TRAEX® RACK MASTER® ICE FILLER

ITEM NUMBER	DESCRIPTION	DEEP	CASE PACK
*TR-3561	16 COMPARTMENT, FITS 19 3/4" X 19 3/4" WAREWASHING RACKS	1 7/16"	3 EA.
*TR-3560	25 COMPARTMENT, FITS 19 3/4" X 19 3/4" WAREWASHING RACKS	1 7/16"	3 EA.
*TR-3562	36 COMPARTMENT, FITS 19 3/4" X 19 3/4" WAREWASHING RACKS	1 7/16"	3 EA.

## TRAEX® RACK FULL SIZE COLORS AVAILABLE

BEIGE (32) (STANDARD)	RED (02)	BLACK (06)	YELLOW (08)
GREEN (19)	BURGUNDY (21)	ROYAL BLUE (44)	

CUSTOM COLORS ARE QUOTED TO ORDER. PLEASE CALL US FOR PRICING  
508-892-9618

# WAREWASHING RACKS

## TRAEX® PLATE CRATE WASHING SYSTEM

COMPLETE WASHING, TRANSPORTING, AND STORING SYSTEM

**\*ALL TRAEX® RACKS ARE  
MADE TO ORDER. CAN'T BE  
CHANGED, CANCELLED, OR  
RETURNED ONCE ORDERED.**

- HIGH-QUALITY CO-POLYMER PLASTIC
- 22 DIFFERENT PLATE CRATES GIVE OPERATORS THE PERFECT CRATE FOR WASHING, STORING, AND TRANSPORTING CHINA
- PLATE CRATES CONSIST OF TR-1 BASE RACK AND WIRE GRIDS THAT SNAP INTO TR-A OPEN EXTENDERS
- LESS BREAKAGE, CLEANER CHINA, FASTER DRYING, STACKABILITY, DURABILITY, CONVENIENT HANDLING, AND SHORTER LEAD TIME
- HANDLES ON ALL FOUR SIDES OF SALT AND PEPPER SHAKERS, BUD VASES, SHOT GLASSES, AND CANDLE HOLDERS, EASY TO TRANSPORT
- POWDER-PAINTED WIRE GRIDS CUSHION PLATES AND PREVENT CORROSION
- PLATE-CRATE RACKS ARE AVAILABLE IN 5 VIBRANT COLORS PLUS BLACK AND BEIGE

- LESS BREAKAGE
- CLEANER CHINA
- FASTER DRYING

- STACKABILITY
- DURABILITY
- CONVENIENT HANDLING

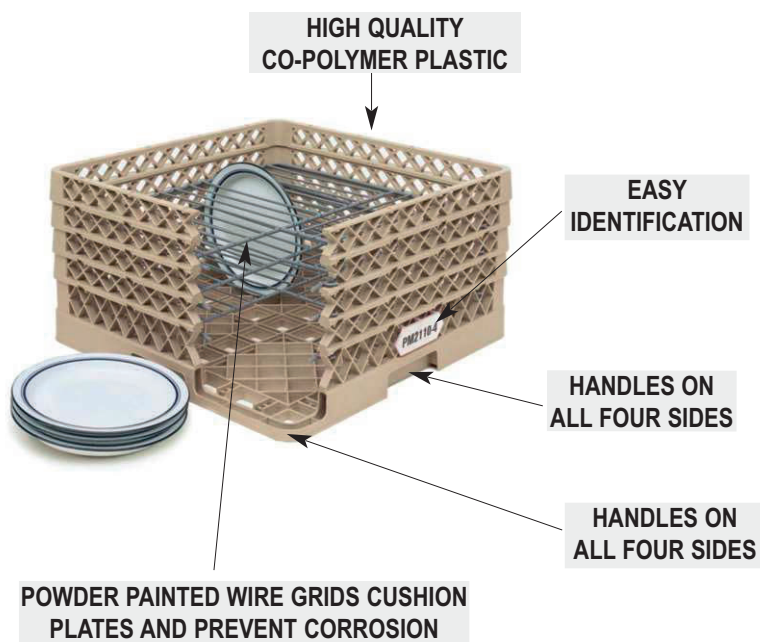

### TRAEX® PLATE CRATE WASHING SYSTEM

ITEM NUMBER	DESCRIPTION	PLATE SIZE RANGE	MAX PLATE DEPTH	PLATE PER RACK	CASE PACK
*PM1412-6	PLATE RACK W/ SIX EXTENDERS	10 3/4" TO 12 5/16"	UP TO 1 3/8"	14	1 EA.
*PM1912-6	PLATE RACK W/ SIX EXTENDERS	11" TO 12"	UP TO 1"	19	1 EA.
*PM0912-6	PLATE RACK W/ SIX EXTENDERS	11 1/4" TO 12 1/2"	UP TO 2 3/8"	9	1 EA.
*PM1211-6	PLATE RACK W/ SIX EXTENDERS	10 3/4" TO 11 3/16"	UP TO 1 3/4"	12	1 EA.
*PM2011-6	PLATE RACK W/ SIX EXTENDERS	10 3/4" TO 11"	UP TO 1"	20	1 EA.
*PM1510-5	PLATE RACK W/ FIVE EXTENDERS	9" TO 10 3/4"	UP TO 1 3/8"	15	2 EA.
*PM1211-5	PLATE RACK W/ FIVE EXTENDERS	9 3/16" TO 10 3/4"	UP TO 1 3/4"	12	2 EA.
*PM2011-5	PLATE RACK W/ FIVE EXTENDERS	10" TO 10 3/4"	UP TO 1"	20	2 EA.
*PM2110-5	PLATE RACK W/ FIVE EXTENDERS	9 3/16" TO 10"	UP TO 1"	21	2 EA.
*PM1211-4	PLATE RACK W/ FOUR EXTENDERS	8 3/4" TO 9 3/16"	UP TO 1 3/4"	12	2 EA.
*PM2110-4	PLATE RACK W/ FOUR EXTENDERS	8 3/4" TO 9 3/16"	UP TO 1"	21	2 EA.
*PM2209-4	PLATE RACK W/ FOUR EXTENDERS	7" TO 7 7/8"	UP TO 1 3/8"	22	2 EA.
*PM3008-4	PLATE RACK W/ FOUR EXTENDERS	8" TO 8 3/4"	UP TO 1"	30	2 EA.
*PM3208-4	PLATE RACK W/ FOUR EXTENDERS	7 5/8" TO 8"	UP TO 1"	32	2 EA.
*PM3208-3	PLATE RACK W/ THREE EXTENDERS	4 3/4" TO 7 5/8"	UP TO 1"	32	2 EA.
*PM4407-3	PLATE RACK W/ THREE EXTENDERS	6" TO 7"	UP TO 3/4"	44	2 EA.
*PM2006-3	PLATE RACK W/ THREE EXTENDERS	4 3/4" TO 6 1/2"	UP TO 2"	20	2 EA.
*PM2209-3	PLATE RACK W/ THREE EXTENDERS	7" TO 8 3/4"	UP TO 1 3/8"	22	2 EA.
*PM4806-2	PLATE RACK W/ TWO EXTENDERS	5" TO 6"	3/4"	48	2 EA.
*PM3807-2	PLATE RACK W/ TWO EXTENDERS	5" TO 6 1/8"	UP TO 1"	38	2 EA.

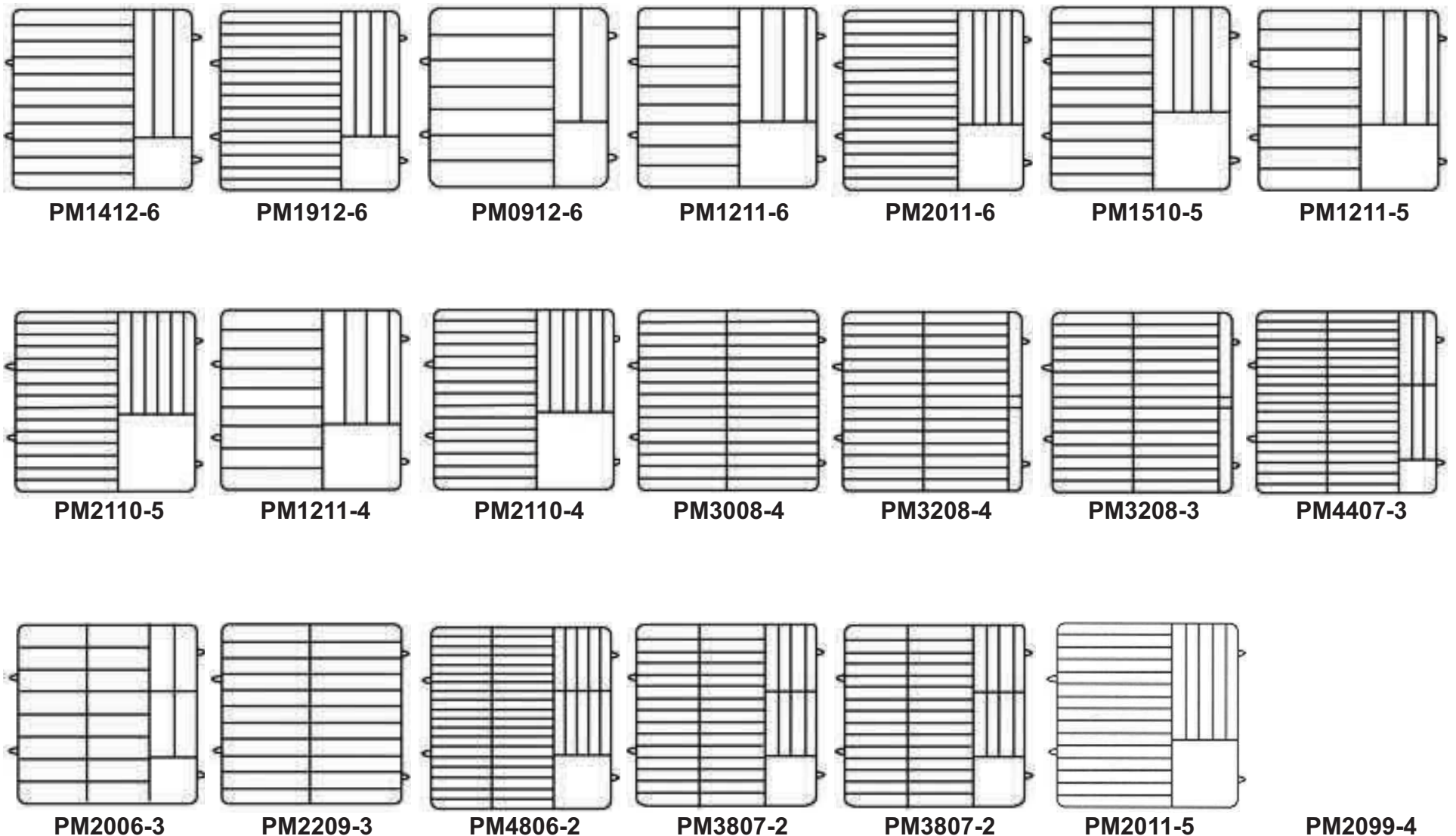

# WAREWASHING RACKS

## TRAEX® HALF SIZE GLASS RACKS

- OPEN PROFILE ALLOWS TOP-TO-BOTTOM AND SIDE-TO-SIDE THOROUGH WASHING AND AIR CIRCULATION
- SNAP FIT EXTENDERS WILL NOT LOOSEN AND WILL NOT COME APART
- EASY GRIP HANDLES ARE MOLDED INTO ALL FOUR SIDES FOR EASY ACCESS
- DOUBLE WALL CONSTRUCTION ADDS STRENGTH AND DURABILITY
- OVERALL OUTSIDE DIMENSIONS: 10" X 19 3/4"
- IDEAL FOR STORAGE AND WASHING OF SALT AND PEPPER SHAKERS, BUD VASES, SHOT GLASSES, AND CANDLE HOLDERS, EASY TO TRANSPORT
- ALL HALF BASES AND EXTENDERS ARE ONLY AVAILABLE IN STANDARD BEIGE

**\*ALL TRAEX® RACKS ARE MADE TO ORDER. CAN'T BE CHANGED, CANCELLED, OR RETURNED ONCE ORDERED.**

TR-HR1B1



## TRAEX® HALF SIZE 8 COMPARTMENT SQUARE RACKS

ITEM NUMBER	DESCRIPTION	OVERALL DIMENSIONS	COMPARTMENT SIZE	COMPARTMENT HEIGHT	CASE PACK
*TR-HR1B1	HALF RACK W/ ONE EXTENDER	10" X 19 3/4" X 3 13/16"	4 1/8" SQ.	3"	6 EA.

TR-HR1C

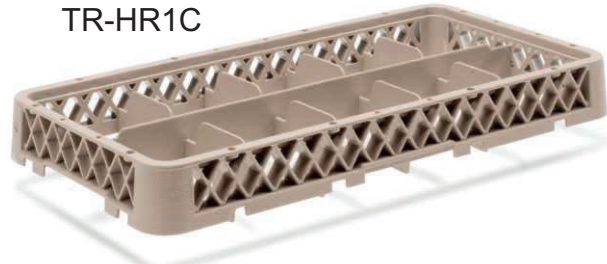

## TRAEX® HALF SIZE 10 COMPARTMENT SQUARE RACKS

ITEM NUMBER	DESCRIPTION	OVERALL DIMENSIONS	COMPARTMENT SIZE	COMPARTMENT HEIGHT	CASE PACK
*TR-HR1C1	HALF RACK W/ ONE EXTENDER	10" X 19 3/4" X 3 13/16"	4 1/8" SQ.	3"	6 EA.

TR-HR1D1

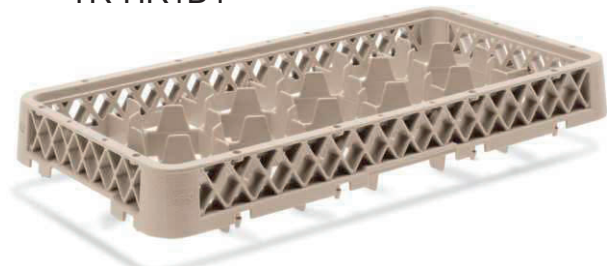

## TRAEX® HALF SIZE 17 COMPARTMENT HEXAGON RACKS

ITEM NUMBER	DESCRIPTION	OVERALL DIMENSIONS	COMPARTMENT SIZE	COMPARTMENT HEIGHT	CASE PACK
*TR-HR1D1	HALF RACK W/ ONE EXTENDER	10" X 19 3/4" X 3 13/16"	2 15/16" HEXAGON	3"	6 EA.

THIS HEXAGON DESIGN REDUCES GLASS BREAKAGE THROUGH BUILT IN BASE RACK DIVIDERS THAT PROVIDE 100% VERTICAL GLASSWARE PROTECTION. THE DOUBLE-WALL DESIGN ABSORBS THE IMPACT OF THE MOVING RACK ELIMINATING BROKEN GLASSES, AND REINFORCED INDEX STRIPS WITHSTAND THE ABUSE OF CONVEYOR DISHWASHING MACHINES.

TR-HR1F



## TRAEX® HALF SIZE 17 COMPARTMENT HEXAGON RACKS

ITEM NUMBER	DESCRIPTION	OVERALL DIMENSIONS	COMPARTMENT SIZE	COMPARTMENT HEIGHT	CASE PACK
*TR-HR1F	HALF RACK W/ ONE EXTENDER	10" X 19 3/4" X 3 13/16"	3" HEXAGON	3"	6 EA.
*TR-HR1FF	HALF RACK W/ TWO EXTENDERS	10" X 19 3/4" X 5 9/16"	3" HEXAGON	4 3/4"	6 EA.
*TR-HR1FA	HALF RACK W/ ONE EXTENDER AND ONE EXTENDER	10" X 19 3/4" X 5 9/16"	3" HEXAGON	4 3/4"	6 EA.

TR-HR2

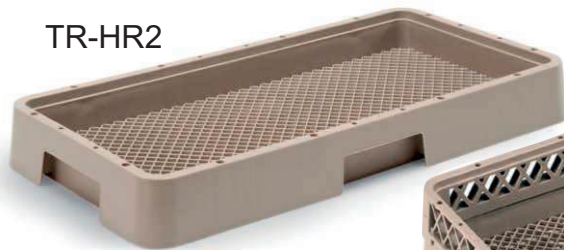

TR-HR2A



- MESH SURFACE KEEPS FLATWARE AND SMALLER ITEMS IN THE RACK
- OUTSIDE DIMENSIONS: 10" X 19 3/4"

## TRAEX® HALF SIZE FLATWARE RACKS

ITEM NUMBER	DESCRIPTION	OVERALL HEIGHT	INSIDE HEIGHT	CASE PACK
*TR-HR2	FLATWARE RACK	2 1/16"	1 1/4"	12 EA.
*TR-HR2A	FLATWARE RACK W/ OPEN EXTENDER	3 13/16"	1 1/4"	6 EA.

TR-HR1



TR-HR1A



- IDEAL FOR LARGE AND UNIQUE SHAPED ITEM
- OUTSIDE DIMENSIONS: 10" X 19 3/4"

## TRAEX® HALF SIZE OPEN RACKS

ITEM NUMBER	DESCRIPTION	OVERALL HEIGHT	INSIDE HEIGHT	CASE PACK
*TR-HR1	OPEN HALF RACK	2 1/16"	1 1/4"	12 EA.
*TR-HR1A	OPEN HALF RACK WITH 1 EXTENDER	3 13/16"	3"	6 EA.
*TR-HR1AA	OPEN HALF RACK WITH 2 EXTENDERS	5 9/16"	4 3/4"	4 EA.

# WAREWASHING RACKS, DOLLIES, & DISH CADDIES

TR-HRBD1



TR-HRA



TR-HRB



TR-HRC1

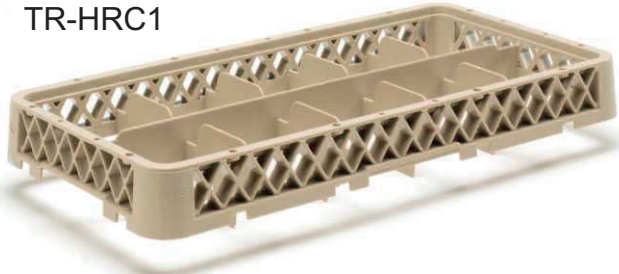

## TRAEX® HALF SIZE GLASS & CUP EXTENDERS

ITEM NUMBER	DESCRIPTION	DIMENSIONS H. X W. X L.	COMPARTMENT SIZE	MAX HEIGHT	CASE PACK
*TR-HRA	OPEN EXTENDER	2" X 10" X 19 3/4"	8 3/8" X 18 1/4"	1 3/4"	12 EA.
*TR-HRB	8 COMPARTMENT EXTENDER	2" X 10" X 19 3/4"	4 1/8" X 4 7/16"	1 3/4"	12 EA.
*TR-HRB1	8 COMPARTMENT DROPPED EXTENDER	3 1/8" X 10" X 19 3/4"	4 1/8" X 4 7/16"	1 3/4"	12 EA.
*TR-HRC	10 COMPARTMENT EXTENDER	2" X 10" X 19 3/4"	3 5/8" X 4 1/4"	1 3/4"	12 EA.
*TR-HRC1	10 COMPARTMENT DROPPED EXTENDER	3 1/8" X 10" X 19 3/4"	3 5/8" X 4 1/4"	1 3/4"	12 EA.
*TR-HRD	17 COMPARTMENT EXTENDER	19 3/4" X 19 3/4" X 1 3/4"	2 15/16" HEXAGON	1 3/4"	12 EA.
*TR-HRD1	17 COMPARTMENT DROPPED EXTENDER	3 1/8" X 10" X 19 3/4"	2 15/16" HEXAGON	1 3/4"	12 EA.
*TR-HRF	17 COMPARTMENT EXTENDER	19 3/4" X 19 3/4" X 1 3/4"	3" HEXAGON	1 3/4"	12 EA.

HR-1370

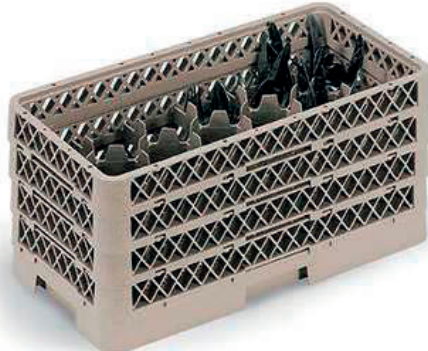

- HEAVY-DUTY, LONG WEARING
- CYLINDERS FIT IN TO CYLINDER WASHING RACK, TRANSPORT RACK
- VERTICAL WASHING AND DRYING IS PREFERRED FOR FLATWARE
- CYLINDERS SOLD SEPARATELY
- NSF CERTIFIED

- TWO BASKETS FIT FULL-SIZE OPEN RACK
- BASKETS NEST WITHIN THEIR FAMILIES FOR COMPACT STORAGE
- INSIDE COMPARTMENT: 3 9/16" X 3 9/16" X 4 1/4"

**\*ALL TRAEX® RACKS ARE MADE TO ORDER. CAN'T BE CHANGED, CANCELLED, OR RETURNED ONCE ORDERED.**



## TRAEX® FLATWARE WASHING SYSTEMS, CYLINDERS & STORAGE

ITEM NUMBER	DESCRIPTION	SIZES	CASE PACK
*TR-HR1370	HALF RACK WITH 8 FLATWARE CYLINDER	19 3/4" X 10" X 9 1/16"	3 EA.
*HR-2D1DDA	17 COMPARTMENT	19 3/4" X 10" X 9 1/16"	2 EA.
AC-1370	FLATWARE CYLINDER -BEIGE PLASTIC	4 1/2" DIA. X 5 5/8"	36 EA.

## TRAEX® FLATWARE BASKETS

ITEM NUMBER	DESCRIPTION	INSIDE COMPARTMENT	OVERALL HEIGHT	INSIDE HEIGHT	CASE PACK
*TR-1371	FLATWARE BASKET WITHOUT HANDLES	3 1/2" SQ.	5 7/8"	4 1/4"	6 EA.
*TR-1372	FLATWARE BASKET WITH HANDLES	3 1/2" SQ.	5 7/8"	4 1/4"	6 EA.

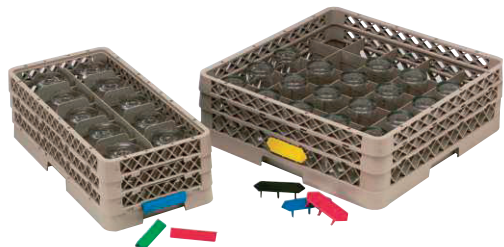

**FITS TRAEX RACKS ONLY!**

### TRAEX® CODE-A-CLIP™ OR IMPRINTS

AVAILABLE IN A VARIETY OF COLORS AND DESCRIPTIONS. MAKE GLASSWARE IDENTIFICATION EASY BY FEATURING CODE-A-CLIPS FROM TRAEX. CODE-A-CLIPS GRIP SECURELY ON TO RACKS WITH A 6-LEG DESIGN. SNAPS IN AND STAYS INTACT THROUGH HEAVY USE! COLOR CODE OR IDENTIFY EACH RACK FOR QUICK PRODUCT IDENTIFICATION. CUSTOM DESIGN CLIPS ARE AVAILABLE FOR USE WITH FULL SIZE GLASS RACKS. AVAILABLE IN BROWN (01), RED (02), ORANGE (03), BLUE (04), WHITE (05), BLACK (06), YELLOW (08), GREEN (19). SEE ABOVE. SOLD IN CASE PACKS ONLY. PLEASE SPECIFY COLORS WHEN ORDERING.

ITEM NUMBER	DESCRIPTION	SIZES	CASE PACK
TR-1006	HALF SIZE CODE-A-CLIP™	2 3/4" L. x 3/4" W.	3 DOZEN
TR-1007	EXTENDER CODE-A-CLIP™	4 3/8" L. x 1 5/8" W.	3 DOZEN
TR-1009	FULL SIZE CODE-A-CLIP™		1 DOZEN

### CYLINDER RACK

EACH CYLINDER HAS ITS OWN COMPARTMENT (4 3/8x4 3/8x4 1/2 INCH), SO THAT YOU CAN WASH A SINGLE CYLINDER, OR UP TO AS MANY AS EIGHT AT A TIME. THIS HALF SIZE 8-COMPARTMENT RACK IS AVAILABLE IN LIGHT GREEN OR COCOA. PLEASE SPECIFY COLOR WHEN ORDERING.

TR-412 10" x 19 3/4" x 5 11/16"

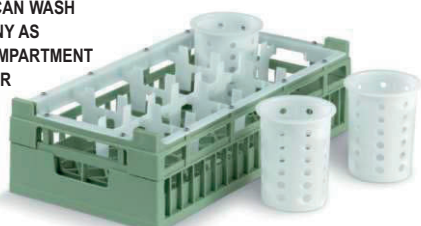

### RACK DOLLY BASE AND HANDLE

- CONSTRUCTED OF IMPACT-RESISTANT COPOLYMER WITH REINFORCED CASTER MOUNTS AND A RIB-REINFORCED BASE
- 5" CASTERS AND OPTIONAL HANDLES FOR SUPERIOR PERFORMANCE •HOLDS UP TO 450 LBS
- HANDLE SOLD SEPARATELY

TX-1697	RACK DOLLY BASE
TX-1698	RACK DOLLY HANDLE
TR-19	36" x 21.5" x 21" VINYL RACK COVER, MUST BUY IN SET OF 3
TR-20	48" x 21.5" x 21" VINYL RACK COVER, MUST BUY IN SET OF 3



### RACK DOLLY BASE AND HANDLE

- CONSTRUCTED FROM HEAVY GAUGE STEEL
- HOLDS FULL SIZE RACKS
- ZINC-PLATED CARBON STEEL DOLLY ABSORBS SHOCK
- USE AS A CAN DOLLY OR STACK CHAIR DOLLY
- 4" NON-MARKING CASTERS
- OVERALL HEIGHT: W/HANDLE 33"; DOLLY ONLY: 5 7/8"
- WEIGHT CAPACITY: 200 LBS.
- HANDLE SOLD SEPARATELY

TX-1930	20 1/2"x20 1/2" RACK DOLLY ONLY, W/O HANDLE
TX-1931	CHROMEPLATE RACK DOLLY HANDLE ONLY



### RACK DOLLY WITH HANDLE

THIS DOLLY RACK WITH HANDLE IS CONSTRUCTED OF POLYETHYLENE WITH CASTER MOUNTS AND BASE. THE CASTERS OFFER STABILITY OVER ROUGH OR UNEVEN SURFACES.

TX-1700 21 1/4" X 21 1/4" X 6 3/8"



### ADJUSTABLE DISH CADDIES

ACCOMMODATES PLATES AND BOWL: SQUARE, 4" - 10 5/8" AND ROUND, 4" - 12 1/2", ALL FOUR CASTERS HAVE BRAKES AND SWIVELS, UNITS STACK EMPTY FOR SPACE SAVING STORAGE, VINYL COVER PROVIDED WITH EVERY DOLLY FOR SANITARY STORAGE, REDUCED FOOTPRINT-OVER ALL DIMENSIONS: 32 3/4" L. x 27 1/2" W. x 30 1/2" H. COLOR: BLACK.



DC-1000	1 POTS, 4 STACK	9 5/8" - 10 5/8" SQUARE PLATES/BOWLS
DC-1001	4 POTS, 4 STACK	8" - 9 1/2" SQUARE PLATES/BOWLS
DC-1002	5 POTS, 4 STACK	8" - 9 1/2" SQUARE PLATES/BOWLS
DC-1003	2 POTS, 4 STACK	10 3/8" - 11 1/4" SQUARE PLATES/BOWLS
DC-1004	4 POTS, 4 STACK	8 1/8" - 9 1/2" SQUARE PLATES/BOWLS
DC-1005	4 POTS, 4 STACK	9 5/8" - 10 1/4" ROUND PLATES/BOWLS
DC-1006	4 POTS, 4 STACK	11 1/2" - 12 1/2" ROUND PLATES/BOWLS
DC-1007	6 POTS, 6 STACK	4" - 8" ROUND PLATES/BOWLS

# WAREWASHING WIRE RACKS

## MICROWIRE PRODUCTS (PLASTIC COATED WIRE RACKS)

THESE WIRE DISH BASKETS ARE GREAT FOR WASHING, STORAGE, AND TRANSPORTATION OF DISHES.

USE 24 COMPARTMENT RACKS FOR HOMER LAUGHLIN PRODUCT AND DOMESTIC PRODUCT.



DB-90124

### 24 COMPARTMENT DISH BASKETS FOR HOMER LAUGHLIN PRODUCT AND DOMESTIC PRODUCT

ITEM NUMBER	DESCRIPTION	OVERALL DIMENSIONS	PLATE SIZE	CASE PACK
DB-90124	HOLDS ROUND OR SQUARE 11" DINNER PLATE	19 3/4" X 12" X 1 2"	UP TO 11"	1 EA.
DB-90224	HOLDS ROUND OR SQUARE 10" PLATE 10" PLATE, 10" SNACK PLATE, 9" LUNCH PLATE	19 3/4" X 11" X 1 1"	UP TO 10"	1 EA.
DB-90324	HOLDS ROUND OR SQUARE 7" SALAD PLATE, 8" RIM SOUP, 8" GLASS PLATE	19 3/4" X 8 1/2" X 8 1/2"	UP TO 7 1/2"	1 EA.
DB-90424	HOLDS ROUND OR SQUARE 6" BREAD & BUTTER PLATE, 6" FRUIT DISH, 6" GLASS PLATE	19 3/4" X 7 1/2" X 7 1/2"	UP TO 6 1/2"	1 EA.
DB-90524	HOLDS ROUND OR SQUARE 5 1/2" SAUCER	19 3/4" X 6 1/2" X 6 1/2"	UP TO 5 1/2"	1 EA.



DB-90120

### 20 COMPARTMENT DISH BASKETS FOR IMPORT PRODUCT

ITEM NUMBER	DESCRIPTION	OVERALL DIMENSIONS	PLATE SIZE	CASE PACK
DB-90120	HOLDS ROUND OR SQUARE 11" DINNER PLATE	19 3/4" X 12" X 1 2"	UP TO 11"	1 EA.
DB-90220	HOLDS ROUND OR SQUARE 10" PLATE 10" PLATE	19 3/4" X 11" X 1 1"	UP TO 10"	1 EA.
DB-90320	HOLDS ROUND OR SQUARE 7 1/2" SALAD PLATE	19 3/4" X 8 1/2" X 8 1/2"	UP TO 7 1/2"	1 EA.
DB-90420	HOLDS ROUND OR SQUARE 6 1/2" BREAD & BUTTER PLATE	19 3/4" X 7 1/2" X 7 1/2"	UP TO 6 1/2"	1 EA.
DB-90520	HOLDS ROUND OR SQUARE 5 1/2" SAUCER	19 3/4" X 6 1/2" X 6 1/2"	UP TO 5 1/2"	1 EA.



DB-205

### 5 COMPARTMENT DISH BASKETS

ITEM NUMBER	DESCRIPTION	OVERALL DIMENSIONS	PLATE SIZE	CASE PACK
DB-205	HOLDS 6" BREAD & BUTTER, 6" GLASS PLATE	12" X 7" X 7 1/8"	2 1/8" X 6 1/2" X 6 1/2"	1 EA.
DB-215	HOLDS 10" SNACK PLATE	14 3/8" X 11 3/8" X 1 1"	21/2" X 10 3/4" X 10 3/8"	1 EA.
DB-225	HOLDS 6" FRUIT DISH	16 1/4" X 7 1/4" X 6 3/4"	3" X 6 7/8" X 6 3/8"	1 EA.
DB-235	HOLDS 7" SALAD PLATE	12 1/2" X 8 1/2" X 8"	2 1/4" X 8 1/8" X 7 5/8"	1 EA.
DB-245	HOLDS 9" ROUND VAGE DISH	21 3/4" X 10" X 10 1/4"	4" X 9 7/8" X 9 1/2"	1 EA.
DB-255	HOLDS 9" LUNCH PLATE	13 3/4" X 10 3/4" X 10 1/2"	2 3/8" X 10 1/8" X 9 1/2"	1 EA.
DB-265	HOLDS 10" DINNER PLATE	14 3/4" X 11 3/4" X 1 1/2"	2 3/8" X 11 3/8" X 1 1/8"	1 EA.
DB-275	HOLDS 8" RIM SOUP DISH, 8" GLASS PLATE, GRAVY BOAT, SOUP/CEREAL	18 1/8" X 9 1/2" X 8 1/2"	3 3/8" X 9" X 8 1/2"	1 EA.
DB-285	HOLDS SAUCER	12 3/4" X 7 1/4" X 6 3/4"	2 3/8" X 6 5/8" X 6 1/4"	1 EA.
DB-325	HOLDS MEAT & VAGE. PLATE	16" X 10 1/8" X 8 3/8"	3" X 9 1/2" X 7 1/2"	1 EA.

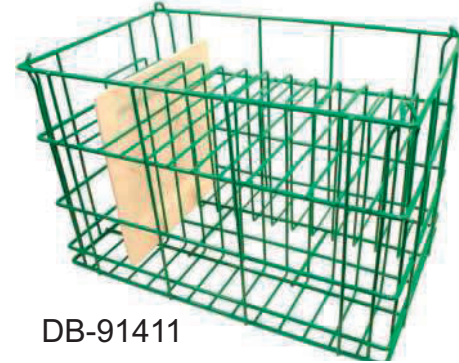

DB-91411

### 14 COMPARTMENT DISH BASKET FOR SQUARE & DEEP PLATES

ITEM NUMBER	DESCRIPTION	OVERALL DIMENSIONS	PLATE SIZE	CASE PACK
DB-91411	HOLDS SQUARE DINNER PLATE	20" X 12 1/2" X 12 1/2"	UP TO 11"	1 EA.
DB-91409	HOLDS SQUARE SALAD PLATE	20" X 9 3/4" X 9 3/4"	UP TO 9"	1 EA.
DB-91407	HOLDS SQUARE BREAD & BUTTER PLATE	20" X 8 1/4" X 8 1/4"	UP TO 8"	1 EA.

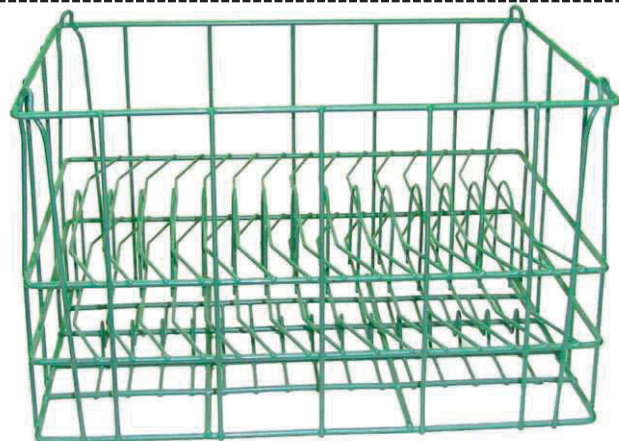

### 16 COMPARTMENT OVAL SERVING PLATTER RACK

ITEM NUMBER	OVERALL DIMENSIONS	COMPARTMENT SIZE	CASE PACK
DB-91116	18 3/4" X 13 1/2" X 11 1/4"	13"W X 10 3/4" T X 7/8" D	1 EA.

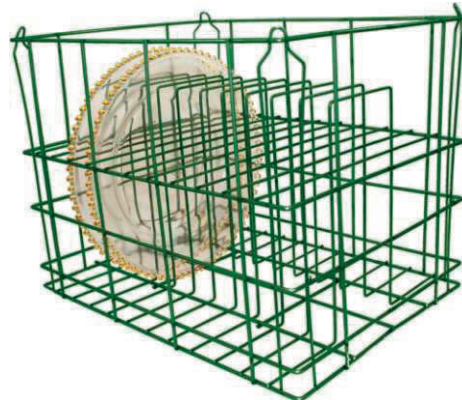

### 12 COMPARTMENT CHARGER PLATES RACK

ITEM NUMBER	OVERALL DIMENSIONS	PLATE SIZE	CASE PACK
DB-91312	15 1/2" X 14 1/2" X 14"	UP TO 13"	1 EA.
DB-91214	19.75" X 15" X 15.5"	UP TO 14"	1 EA.



### 15 COMPARTMENT SOUP BOWL RACK

ITEM NUMBER	OVERALL DIMENSIONS	COMPARTMENT SIZE	CASE PACK
DR-91215	19.75" X 9.5" X 10"	?	1 EA.

# WAREWASHING WIRE RACKS

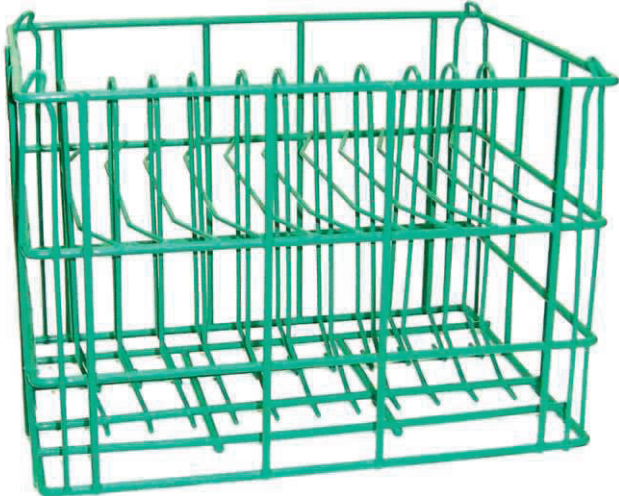

**12 COMPARTMENT PASTA BOWL RACK/ 12" ROUND PLATTER RACK**

ITEM NUMBER	OVERALL DIMENSIONS	COMPARTMENT SIZE	CASE PACK
DR-90712	18 3/4" X 13 1/2" X 11 1/4"	?	1 EA.



**8 COMPARTMENT FLATWARE RACK WITH CYLINDERS**

ITEM NUMBER	OVERALL DIMENSIONS	COMPARTMENT SIZE	CASE PACK
SB-5569	19 3/4" L X 10 1/2" W X 9 5/8" H	4 1/2" SQ.	1 EA.

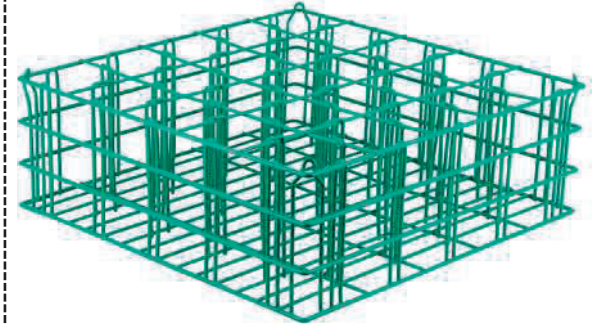

**IRISH COFFEE MUG RACK HOLDS UP TO 25 MUGS**

ITEM NUMBER	OVERALL DIMENSIONS	COMPARTMENT SIZE	CASE PACK
GR-9025	18.75" X 18.75" X 6"	3 7/8" X 6 1/4"	1 EA.

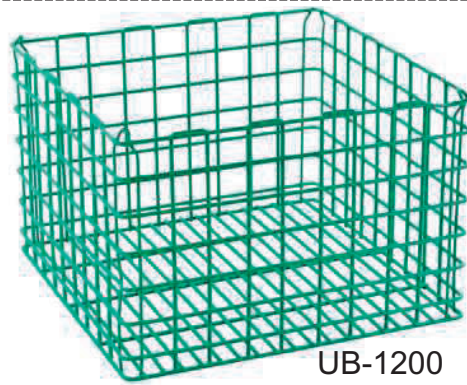

UB-1200

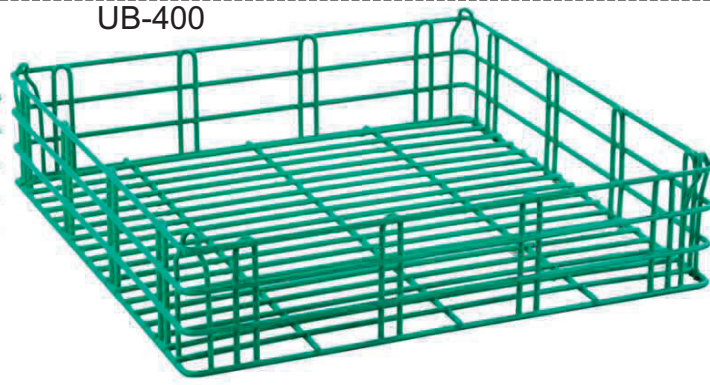

UB-400

**ALL PURPOSE BASKETS**

ITEM NUMBER	OVERALL DIMENSIONS	CASE PACK
UB-400	18 3/4" X 18 1/2" X 4 1/4"	1 EA.
UB-1200	18 3/4" X 18 1/2" X 12 1/4"	1 EA.



GB-99

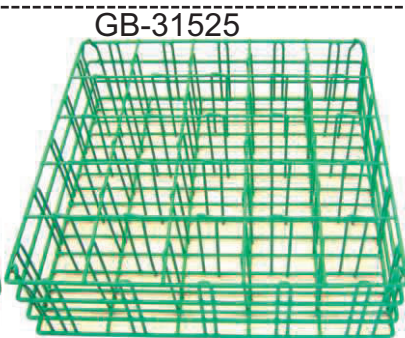

GB-31525



GB-66516

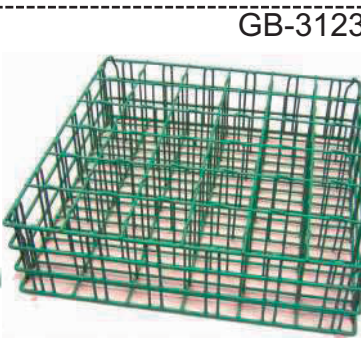

GB-31236



GR-9759

**WIRE BASKETS**

ITEM NUMBER	DESCRIPTION	OVERALL DIMENSIONS	COMPARTMENT SIZE	CASE PACK
GB-99	9 COMPARTMENT DISH BASKET FOR ASH TRAY, SUGAR BOWL	18 3/4" L. X 18 3/4" W.	6" X 6" X 3"H.	1 EA.
GB-616	16 COMPARTMENT DISH BASKET	18 3/4" L. X 18 3/4" W.	4 1/2" X 4 1/2" X 5" H.	1 EA.
GB-716	16 COMPARTMENT DISH BASKET FOR TEA CUP	18 3/4" L. X 18 3/4" W.	4 1/2" X 4 1/2" X 3" H.	1 EA.
GB-66516	16 COMPARTMENT DISH BASKET FOR WATER GOBLET GLASS	18 3/4" L. X 18 3/4" W.	4 1/2" X 4 1/2" X 5" H.	1 EA.
GB-325	25 COMPARTMENT DISH BASKET FOR 7 OZ. ROCKS, 8.5 OZ. WINE, 12 OZ. GOBLET, 4.5 OZ - 5.5 OZ. CHAMPAGNE, & 12 OZ. PILSNER GLASS	18 3/4" L. X 18 3/4" W.	3 1/2" X 3 1/2" X 6" H.	1 EA.
GB-425	25 COMPARTMENT	18 3/4" L. X 18 3/4" W.	3 1/2" X 3 1/2" X 8" H.	1 EA.
GB-525	25 COMPARTMENT DISH BASKET FOR 10 OZ. OLD FASHION, 6 OZ PUNCH CUP	18 3/4" L. X 18 3/4" W.	3 1/2" X 3 1/2" X 3 3/8"H.	1 EA.
GB-5025	25 COMPARTMENT DISH BASKET FOR MUGS & IMPORT CUPS	18 3/4" L. X 18 3/4" W.	3 1/2" X 3 1/2" X 4" H.	1 EA.
GB-136	36 COMPARTMENT DISH BASKET FOR 4.5 OZ. COCKTAIL, 4 OZ. WHISKEY, 8 OZ. HIGH BALL, 10 OZ. COLLINS, & 6 1/2 OZ. WINE GLASS	18 3/4" L. X 18 3/4" W.	2 3/4" X 2 3/4" X 5 3/4" H.	1 EA.
GB-7736	36 COMPARTMENT DISH BASKET FOR TULIP CHAMPAGNEGLASS	18 3/4" L. X 18 3/4" W.	2 3/4" X 2 3/4" X 8 5/8" H.	1 EA.
GB-30216	16 COMPARTMENT DISH BASKET FOR TEA CUP	19 1/4" L. X 19 1/4" W.	4 3/8" X 4 3/8" X 2 3/4" H.	1 EA.
GB-31325	25 COMPARTMENT DISH BASKET FOR 7 OZ. ROCKS, 8.5 OZ. WINE, 12 OZ. GOBLET, 4.5 OZ - 5.5 OZ. CHAMPAGNE, & 12 OZ. PILSNER GLASS	19 1/4" L. X 19 1/4" W.	3 1/2" X 3 1/2" X 6 1/2" H.	1 EA.
GB-31525	25 COMPARTMENT DISH BASKET	19 1/4" L. X 19 1/4" W.	3 1/2" X 3 1/2" X 5 1/4" H.	1 EA.
GB-31625	25 COMPARTMENT DISH BASKET	19 1/4" L. X 19 1/4" W.	3 1/2" X 3 1/2" X 8" H.	1 EA.
GB-32625	25 COMPARTMENT DISH BASKET	19 1/4" L. X 19 1/4" W.	3 1/2" X 3 1/2" X 9" H.	1 EA.
GB-31236	36 COMPARTMENT DISH BASKET FOR 4.5 OZ. COCKTAIL, 4 OZ. WHISKEY, 8 OZ. HIGH BALL, 10 OZ. COLLINS, & 6 1/2 OZ. WINE GLASS	19 1/4" L. X 19 1/4" W.	2 7/8" X 2 7/8" X 5 1/4" H.	1 EA.
GB-31436	36 COMPARTMENT DISH BASKET	19 1/4" L. X 19 1/4" W.	2 7/8" X 2 7/8" X 6 1/2" H.	1 EA.
GB-314036	36 COMPARTMENT DISH BASKET FOR TULIP CHAMPAGNEGLASS	19 1/4" L. X 19 1/4" W.	2 7/8" X 2 7/8" X 9" H.	1 EA.
GR-9759	9 COMPARTMENT FOR LIBBY MARGARITA, MARTINI GLASS	15 5/8" X 15 5/8" X 7"	4 3/4" X 4 3/4"	1 EA.
GR-168416	16 COMPARTMENT FOR LARGE BALLOON GLASSES	19" X 19" X 8"	4 3/8" X 4 3/8"	1 EA.

# DISPOSABLE PRODUCTS



**WHITE WITH SILVER BAND DISPOSABLE PLATES, BOWLS & MUGS (PLASTIC)**

ALL SALES FINAL

EACH ITEM IS SOLD AS A CASE PACK ONLY.

DP-8820	DESSERT PLATE	6" DIA.	CASE PACK
DP-8821	SALAD PLATE	7" DIA.	150 EACH
DP-8822	LUNCHEON PLATE	9" DIA.	150 EACH
DP-8823	DINNER PLATE	10" DIA.	120 EACH
DP-8824	BOWL	12 OZ.	120 EACH
DP-8825	COFFEE MUG	8 OZ.	150 EACH

SILVER BANDED



**IVORY WITH GOLD BAND DISPOSABLE PLATES, BOWLS & MUGS (PLASTIC)**

ALL SALES FINAL

EACH ITEM IS SOLD AS A CASE PACK ONLY.

DP-8830	DESSERT PLATE	6" DIA.	CASE PACK
DP-8831	SALAD PLATE	7" DIA.	150 EACH
DP-8832	LUNCHEON PLATE	9" DIA.	150 EACH
DP-8833	DINNER PLATED	10" DIA.	120 EACH
DP-8834	BOWL	12 OZ.	120 EACH
DP-8835	COFFEE MUG	8 OZ.	150 EACH

GOLD BANDED



**WHITE WITH SILVER BAND DISPOSABLE PLATES (PLASTIC)**  
EACH ITEM IS SOLD AS A CASE PACK OF 120 ONLY.

SILVER BANDED

DP-8800	PLATE	10" SQ.	CASE PACK
DP-8801	PLATE	7.25" SQ.	120 EACH
DP-8802	PLATE	4.5" SQ.	120 EACH



**BLACK WITH SILVER BAND DISPOSABLE PLATES AND BOWLS (PLASTIC)**

ALL SALES FINAL

EACH ITEM IS SOLD AS A CASE PACK ONLY.

DP-8840S	DESSERT PLATE	6" DIA.	CASE PACK
DP-8841S	SALAD PLATE	7" DIA.	150 EACH
DP-8842S	LUNCHEON PLATE	9" DIA.	150 EACH
DP-8843S	DINNER PLATE	10" DIA.	120 EACH
DP-8844S	BOWL	12 OZ.	120 EACH

SILVER BANDED



**BLACK WITH GOLD BAND DISPOSABLE PLATES AND BOWLS (PLASTIC)**

ALL SALES FINAL

EACH ITEM IS SOLD AS A CASE PACK ONLY.

DP-8840G	DESSERT PLATE	6" DIA.	CASE PACK
DP-8841G	SALAD PLATE	7" DIA.	150 EACH
DP-8842G	LUNCHEON PLATE	9" DIA.	150 EACH
DP-8843G	DINNER PLATE	10" DIA.	120 EACH
DP-8844G	BOWL	12 OZ.	120 EACH

GOLD BANDED



**IVORY WITH GOLD BAND DISPOSABLE PLATES (PLASTIC)**  
EACH ITEM IS SOLD AS A CASE PACK OF 120 EACH ONLY.

GOLD BANDED

DP-8810	PLATE	10" SQ.	CASE PACK
DP-8811	PLATE	7.25" SQ.	120 EACH
DP-8812	PLATE	4.5" SQ.	120 EACH



**IVORY HERITAGE DISPOSABLE DINNERWARE, BONE WITH GOLD DESIGN (PLASTIC)**  
SOLD IN THE CASE PACKS OF 120 EACH ONLY.

ALL SALES FINAL

DP-8930	PLATE	10" DIA.	CASE PACK
DP-8931	PLATE	7.25" DIA.	120 EACH
DP-8932	BOWL	10 OZ.	120 EACH



**SIGNATURE BLUE WITH GOLD PATTERN DISPOSABLE DINNERWARE (PLASTIC)**  
SOLD IN THE CASE PACKS OF 120 EACH ONLY.

ALL SALES FINAL

DP-2240	PLATE	10.25" DIA.	CASE PACK
DP-2241	PLATE	7.5" DIA.	120 EACH
DP-2242	BOWL	12 OZ.	120 EACH



**WHITE WITH COBALT & GOLD TRIM SQUARE DISPOSABLE PLATES (PLASTIC)**  
SOLD IN THE CASE PACKS OF 120 EACH ONLY.

ALL SALES FINAL

DP-8920	PLATE	10" SQ.	CASE PACK
DP-8921	PLATE	7.25" SQ.	120 EACH
DP-8922	PLATE	4.5" SQ.	120 EACH



**BLACK SCALLOPED EDGE DISPOSABLE PLATES & BOWLS (PLASTIC)**  
SOLD IN THE CASE PACKS OF 180 EACH ONLY.

ALL SALES FINAL

DP-2250B	DINNER PLATE	10.25" DIA.	BLACK	CASE PACK
DP-2251B	LUNCH PLATE	9" DIA.	BLACK	180 EACH
DP-2252B	SALAD PLATE	7.5" DIA.	BLACK	180 EACH
DP-2253B	DESSERT PLATE	6" DIA.	BLACK	180 EACH
DP-2254B	DESSERT BOWL	5 OZ.	BLACK	180 EACH
DP-2255B	BOWL	12 OZ.	BLACK	180 EACH
DP-2256B	COFFEE MUG	8 OZ.	BLACK	180 EACH



**BONE SCALLOPED EDGE DISPOSABLE PLATES & BOWLS (PLASTIC)**  
SOLD IN THE CASE PACKS OF 180 EACH ONLY.

ALL SALES FINAL

DP-2250BN	DINNER PLATE	10.25" DIA.	BONE	CASE PACK
DP-2251BN	LUNCH PLATE	9" DIA.	BONE	180 EACH
DP-2252BN	SALAD PLATE	7.5" DIA.	BONE	180 EACH
DP-2253BN	DESSERT PLATE	6" DIA.	BONE	180 EACH
DP-2254BN	DESSERT BOWL	5 OZ.	BONE	180 EACH
DP-2255BN	BOWL	12 OZ.	BONE	180 EACH
DP-2256BN	COFFEE MUG	8 OZ.	BONE	180 EACH

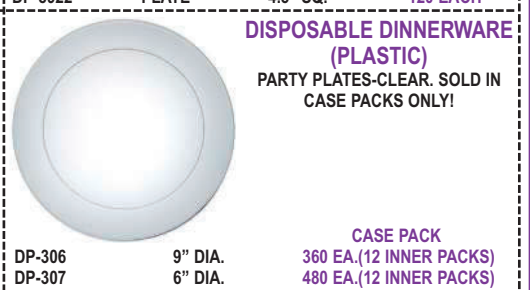

**DISPOSABLE DINNERWARE (PLASTIC)**  
PARTY PLATES-CLEAR. SOLD IN CASE PACKS ONLY!

DP-306	9" DIA.	360 EA.(12 INNER PACKS)
DP-307	6" DIA.	480 EA.(12 INNER PACKS)



**CLEAR SCALLOPED EDGE DISPOSABLE PLATES & BOWLS (PLASTIC)**  
SOLD IN THE CASE PACKS OF 180 EACH ONLY.

ALL SALES FINAL

DP-2250CL	DINNER PLATE	10.25" DIA.	CLEAR	CASE PACK
DP-2251CL	LUNCH PLATE	9" DIA.	CLEAR	180 EACH
DP-2252CL	SALAD PLATE	7.5" DIA.	CLEAR	180 EACH
DP-2253CL	DESSERT PLATE	6" DIA.	CLEAR	180 EACH
DP-2254CL	DESSERT BOWL	5 OZ.	CLEAR	180 EACH
DP-2255CL	BOWL	12 OZ.	CLEAR	180 EACH
DP-2256CL	COFFEE MUG	8 OZ.	CLEAR	180 EACH



**WHITE SCALLOPED EDGE DISPOSABLE PLATES & BOWLS (PLASTIC)**  
SOLD IN THE CASE PACKS OF 180 EACH ONLY.

ALL SALES FINAL

DP-2250W	DINNER PLATE	10.25" DIA.	CLEAR	CASE PACK
DP-2251W	LUNCH PLATE	9" DIA.	CLEAR	180 EACH
DP-2252W	SALAD PLATE	7.5" DIA.	CLEAR	180 EACH
DP-2253W	DESSERT PLATE	6" DIA.	CLEAR	180 EACH
DP-2254W	DESSERT BOWL	5 OZ.	CLEAR	180 EACH
DP-2255W	BOWL	12 OZ.	CLEAR	180 EACH
DP-2256W	COFFEE MUG	8 OZ.	CLEAR	180 EACH



**DISPOSABLE 2 PC. PEDESTAL CAKE STAND (PLASTIC)**  
SOLD IN CASE PACKS OF ONE DOZEN ONLY.

DP-3600	13.75" DIA.	CLEAR	CASE PACK
DP-3601	11.75" DIA.	CLEAR	1 DOZ.
DP-3602	9.75" DIA.	CLEAR	1 DOZ.
DP-3600W	13.75" DIA.	WHITE	1 DOZ.
DP-3601W	11.75" DIA.	WHITE	1 DOZ.
DP-3602W	9.75" DIA.	WHITE	1 DOZ.



**CLEAR DISPOSABLE PLATES & BOWLS WITH SCROLL DESIGN (PLASTIC)**  
SOLD IN THE CASE PACKS OF 240 EACH ONLY.

ALL SALES FINAL

DP-3300	DINNER PLATE	10" DIA.	CLEAR	CASE PACK
DP-3301	LUNCH PLATE	9" DIA.	CLEAR	240 EACH
DP-3302	SALAD PLATE	7" DIA.	CLEAR	240 EACH
DP-3303	B & B PLATE	6.25" DIA.	CLEAR	240 EACH
DP-3304	BOWL	10 OZ.	CLEAR	240 EACH
DP-3305	BOWL	6 OZ.	CLEAR	240 EACH

DP-3300 PLATE

DP-3304 BOWL

DP-3305 BOWL

# DISPOSABLE PRODUCTS

THESE PRODUCTS ARE MADE FROM PLASTIC.



DP-100 DP-101 DP-102 DP-103 DP-104 DP-105



DP-106 DP-107 DP-108 DP-109 DP-110 DP-111

## CLEAR DISPOSABLE DRINKWARE (PLASTIC)

SOLD IN CASE PACKS ONLY!



DP-112 DP-112

ITEM	DESCRIPTION	SIZE	CASE PACK
DP-100	CHAMPAGNE FLUTE, 1 PC.	5 OZ.	60 EA. (6 INNER PACKS)
DP-101	WINE GLASSES, 1 PC.	8 OZ.	48 EA. (6 INNER PACKS)
DP-102	WINE GLASSES, 2 PC.	5.5 OZ.	400 EA. (20 INNER PACKS)
DP-103	CHAMPAGNE GLASSES, 2 PC.	4 OZ.	400 EA. (20 INNER PACKS)
DP-104	MARTINI GLASSES, 2 PC.	8 OZ.	120 EA. (12 INNER PACKS)
DP-105	MARGARITA GLASSES, 2 PC.	12 OZ.	120 EA. (12 INNER PACKS)
DP-106	SHOT GLASSES	1 OZ.	2,500 EA. (10 INNER PACKS)
DP-107	SHOT GLASSES	2 OZ.	1,000 EA. (20 INNER PACKS)
DP-108	OLD FASHIONED TUMBLERS	9 OZ.	500 EA. (20 INNER PACKS)
DP-109	TALL TUMBLERS	10 OZ.	500 EA. (20 INNER PACKS)
DP-110	SHOT GLASSES & LIDS	1.25 OZ.	750 EA. (30 INNER PACKS)
DP-112	CHAMPAGNE GLASSES, 2 PC.		96 EA. (24 INNER PACKS)



DP-201B BLUE DP-2010 ORANGE DP-202B BLUE DP-202P PINK



DP-203P PINK DP-203B BLUE DP-204G GREEN DP-204O ORANGE DP-205A ASSORTED COLORS

## DISPOSABLE NEON DRINKWARE (PLASTIC)

SOLD IN CASE PACKS ONLY!

ITEM	DESCRIPTION	SIZE	COLOR	CASE PACK
DP-201B	MARTINI GLASSES, 2 PC.	8 OZ.	BLUE	120 EA. (12 INNER PACKS)
DP-201G	MARTINI GLASSES, 2 PC.	8 OZ.	GREEN	120 EA. (12 INNER PACKS)
DP-201O	MARTINI GLASSES, 2 PC.	8 OZ.	ORANGE	120 EA. (12 INNER PACKS)
DP-201P	MARTINI GLASSES, 2 PC.	8 OZ.	PINK	120 EA. (12 INNER PACKS)
DP-202B	MARGARITA GLASSES, 2 PC.	12 OZ.	BLUE	120 EA. (12 INNER PACKS)
DP-202G	MARGARITA GLASSES, 2 PC.	12 OZ.	GREEN	120 EA. (12 INNER PACKS)
DP-202O	MARGARITA GLASSES, 2 PC.	12 OZ.	ORANGE	120 EA. (12 INNER PACKS)
DP-202P	MARGARITA GLASSES, 2 PC.	12 OZ.	PINK	120 EA. (12 INNER PACKS)
DP-203A	OLD FASHIONED TUMBLERS	9 OZ.	ASSORTED COLORS	600 EA. (6 INNER PACKS)
DP-203B	OLD FASHIONED TUMBLERS	9 OZ.	BLUE	500 EA. (20 INNER PACKS)
DP-203G	OLD FASHIONED TUMBLERS	9 OZ.	GREEN	500 EA. (20 INNER PACKS)
DP-203O	OLD FASHIONED TUMBLERS	9 OZ.	ORANGE	500 EA. (20 INNER PACKS)
DP-203P	OLD FASHIONED TUMBLERS	9 OZ.	PINK	500 EA. (20 INNER PACKS)
DP-203KG	OLD FASHIONED TUMBLERS KELLY	9 OZ.	GREEN	500 EA. (20 INNER PACKS)
DP-204A	TALL TUMBLERS	10 OZ.	ASSORTED COLORS	600 EA. (6 INNER PACKS)
DP-204B	TALL TUMBLERS	10 OZ.	BLUE	500 EA. (20 INNER PACKS)
DP-204G	TALL TUMBLERS	10 OZ.	GREEN	500 EA. (20 INNER PACKS)
DP-204O	TALL TUMBLERS	10 OZ.	ORANGE	500 EA. (20 INNER PACKS)
DP-204P	TALL TUMBLERS	10 OZ.	PINK	500 EA. (20 INNER PACKS)
DP-205A	SHOT GLASSES	2 OZ.	ASSORTED COLORS	600 EA. (10 INNER PACKS)
DP-205B	SHOT GLASSES	2 OZ.	BLUE	1,000 EA. (20 INNER PACKS)
DP-205G	SHOT GLASSES	2 OZ.	GREEN	1,000 EA. (20 INNER PACKS)
DP-205O	SHOT GLASSES	2 OZ.	ORANGE	1,000 EA. (20 INNER PACKS)
DP-205P	SHOT GLASSES	2 OZ.	PINK	1,000 EA. (20 INNER PACKS)



## DISPOSABLE STEMWARE (PLASTIC)

SOLD IN CASE PACKS ONLY!



DP-8849 DP-8850 DP-8851 DP-8852 DP-8853 DP-8854 DP-8855 DP-8856 DP-8857 DP-8858 DP-8859 DP-8860

ITEM	DESCRIPTION	SIZE	CASE PACK
DP-8849	RIBBED CHAMPAGNE FLUTE, 2 PC.	5 OZ.	120 EACH
DP-8850	RIBBED CHAMPAGNE FLUTE, 1 PC.	5 OZ.	96 EACH
DP-8851	TULIP GLASS, 2 PC.	4 OZ.	360 EACH
DP-8852	RIBBED WINE GLASS, 1 PC.	2 OZ.	240 EACH
DP-8853	RIBBED WINE GLASS, 1 PC.	5.5 OZ.	240 EACH
DP-8854	RIBBED WINE GLASS, 1 PC.	8 OZ.	240 EACH
DP-8855	RIBBED WINE GOBLET, 2 PC.	5 OZ.	360 EACH
DP-8856	RIBBED WINE GOBLET, 2 PC.	6 OZ.	120 EACH
DP-8857	RIBBED WINE GOBLET, 1 PC.	8 OZ.	96 EACH
DP-8858	RIBBED MARTINI GLASS	6 OZ.	144 EACH
DP-8859	RIBBED MARTINI GLASS	12 OZ.	144 EACH
DP-8860	RIBBED DESSERT CUP, 1 PC.	8 OZ.	240 EACH



## DISPOSABLE STEMLESS GLASSES (PLASTIC)

SOLD IN CASE PACKS ONLY!

ITEM	DESCRIPTION	SIZE	CASE PACK
DP-2600	MINI GOBLET	4 OZ.	64 EACH
DP-2601	FLUTE	10 OZ.	64 EACH
DP-2602	GOBLET	12 OZ.	64 EACH

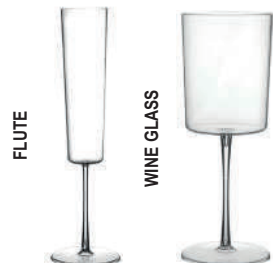

## DISPOSABLE GLASSES (PLASTIC)

SOLD IN CASE PACKS ONLY!

ITEM	DESCRIPTION	SIZE	CASE PACK
DP-4100	CHAMPAGNE FLUTE	7 OZ.	72 EACH
DP-4101	WINE GLASS	11 OZ.	72 EACH

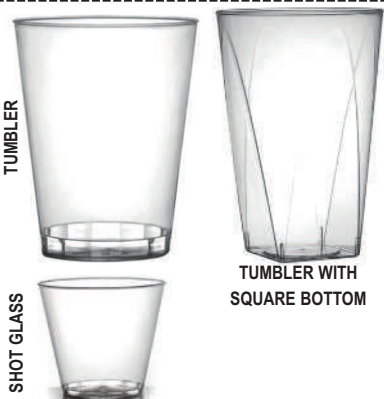

## DISPOSABLE HEAVY WEIGHT GLASSES (PLASTIC)

SOLD IN CASE PACKS ONLY!

ITEM	DESCRIPTION	SIZE	CASE PACK
DP-4000	SHOT GLASS	1 OZ.	2500 EACH
DP-4001	SHOT GLASS	1.5 OZ.	1000 EACH
DP-4002	SHOT GLASS	2 OZ.	2500 EACH
DP-4003	TUMBLER	5 OZ.	500 EACH
DP-4004	TUMBLER	7 OZ.	500 EACH
DP-4005	TUMBLER	8 OZ.	500 EACH
DP-4006	TUMBLER	9 OZ.	500 EACH
DP-4007	TUMBLER	10 OZ.	500 EACH
DP-4008	TUMBLER WITH SQUARE BOTTOM	10 OZ.	500 EACH
DP-4009	TUMBLER	12 OZ.	500 EACH
DP-4010	TUMBLER	14 OZ.	500 EACH
DP-4011	TUMBLER	16 OZ.	500 EACH

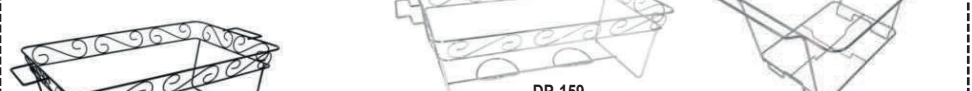

## DISPOSABLE FOIL PAN AND FOIL LID

SOLD IN CASE PACKS ONLY!

ITEM	DESCRIPTION	SIZE	CASE PACK
DP-150	FULL SIZE FOIL LID	20 13/16" X 12 7/8" X 5/8"	50 EA.
DP-151	HALF SIZE FOIL LID	12 13/16" X 10 7/16" X 5/8"	100 EA.
DP-152	FULL SIZE DEEP 126G FOIL PAN	19 9/16" X 11 5/8" X 3 3/16"	50 EA.
DP-153	HALF SIZE DEEP 40G FOIL PAN HEAVY DUTY	11 3/4" X 9 3/8" X 2 9/16"	100 EA.
DP-154	FULL SIZE DEEP-110G FOIL PAN HEAVY DUTY	19 9/16" X 11 5/8" X 3 3/16"	50 EA.
DP-155	HALF SIZE DEEP-33G FOIL PAN HEAVY DUTY	11 3/4" X 9 3/8" X 2 9/16"	100 EA.
DP-157	FULL SIZE WIRE STAND FOR FOIL TRAYS	22.5" L. X 12" W. X 9" H.	1 EA.
DP-158	FULL SIZE WIRE STAND, BLACK		1 DOZ.
DP-159	FULL SIZE WIRE STAND, CHROME		1 DOZ.
DP-160	HALF SIZE WIRE STAND, CHROME		2 DOZ.
CH-7862	CHROMEPLATED FULL SIZE WIRE STAND FOR STAINLESS TRAYS ONLY		1 EA.

## 11 PC DISPOSABLE CHAFER KIT

IDEAL FOR CATERING, OUTDOOR PARTIES AND BANQUET USE. GREAT FOR COOKING, TRANSPORTING, FREEZING, OR REHEATING FOOD. DURABLE AND DISPOSABLE FOR EASY CLEAN-UP. SOLD AS SETS. EACH SET CONTAINS 1 FULL SIZE RACK, 1 FULL SIZE WATER PAN, 2 HALF SIZE FOOD PANS, 2 GEL HEATING FUELS, 2 SERVING FORKS, 2 SERVING SPOONS, AND 1 SERVING TONG.



ITEM	DESCRIPTION	CASE PACK
DP-171	6 SETS/KITS	
DP-172	3 SETS/KITS	
DP-173	36 SETS/KITS	



## STEMLESS WINE GLASSES (DISPOSABLE)

THESE DISPOSABLE GLASSES ARE DURABLE COMMERCIAL PLASTIC DRINKWARE. SOLD IN CASE PACKS ONLY. ALL SALES ARE FINAL.

ITEM	SIZE	COLOR	CASE PACK
DP-5400B	12 OZ.	BLACK	48 EACH
DP-5400W	12 OZ.	WHITE	48 EACH



# DISPOSABLE PRODUCTS

THESE PRODUCTS ARE MADE FROM PLASTIC.

**HEAVY WEIGHT!**



**SILVER DISPOSABLE CUTLERY (PLASTIC)**  
EACH ITEM IS SOLD IN A BULK BOX ONLY.

DP-8880	SPOON	6.25" L.	600 EACH
DP-8881	FORK	7.25" L.	600 EACH
DP-8882	KNIFE	8" L.	600 EACH
DP-8883	BOUILLON SPOON	6" L.	600 EACH
DP-8884	MINI FORK	4" L.	960 EACH
DP-8885	SILVER MINI SPOON	4" L.	960 EACH
DP-8886	COCKTAIL FORK LONG	6" L.	400 EACH
DP-8887	COCKTAIL SPOON LONG	6" L.	400 EACH
DP-8888	NAPKIN ROLLED FORK, SPOON, & KNIFE		100 EACH



**GOLD DISPOSABLE CUTLERY (PLASTIC)**  
EACH ITEM IS SOLD IN A BULK BOX ONLY.

DP-8870	SPOON	6.25" L.	400 EACH
DP-8871	FORK	7.25" L.	400 EACH
DP-8872	KNIFE	8" L.	400 EACH
DP-8873	MINI FORK	4" L.	576 EACH
DP-8874	MINI SPOON	4" L.	576 EACH
DP-8878	NAPKIN ROLLED FORK, SPOON, & KNIFE		70 EACH



**SERVING UTENSILS (PLASTIC)**  
SOLD IN CASE PACKS ONLY.

DP-8890	SERVING SPOON	10" L.	60 EACH
DP-8891	SERVING FORK	10" L.	60 EACH
DP-8892	CAKE CUTTER		40 EACH
DP-8893	TONG	6.5" L.	72 EACH
DP-8894	TONG	8.5" L.	40 EACH



**SERVING UTENSILS (PLASTIC)**  
SOLD IN CASE PACKS ONLY.

DP-8910	CAKE CUTTER	9.5" L.	40 EACH
DP-8911	SERVING SPOON	9" L.	60 EACH
DP-8912	SERVING FORK	9" L.	60 EACH
DP-8913	SERVING TONG	6.5" L.	50 EACH
DP-8914	SERVING TONG	8.5" L.	30 EACH



**DISPOSABLE CUTLERY (PLASTIC)**  
SOLD IN CASE PACKS OF 1,224 ONLY (24 INNER PACKS)

DP-363C	ASSORTED CUTLERY-CLEAR
DP-363W	ASSORTED CUTLERY-WHITE
DP-360C	SPOONS-CLEAR
DP-360W	SPOONS-WHITE
DP-361C	FORKS-CLEAR
DP-361W	FORKS-WHITE
DP-362C	KNIVES-CLEAR
DP-362W	KNIVES-WHITE



**DISPOSABLE PETE BOWLS WITH LIDS**  
THE BOWLS ARE MADE FROM BLACK PETE, WHILE THE LIDS ARE CLEAR PETE. THE LID FEATURES A SECURE LOCKING SEAL AND ANTI-FOG TECHNOLOGY THAT WILL KEEP YOUR FOOD FRESH AND LOOKING BEAUTIFUL. BOWLS AND LIDS ARE SOLD SEPARATE AND IN THE CASE PACK ONLY.

DP-1550	7.5" SQUARE, 32 OZ BOWL	BLACK	300 EA.
DP-1551	9" SQUARE, 48 OZ BOWL	BLACK	150 EA.
DP-1552	10.75" SQUARE, 80 OZ BOWL	BLACK	50 EA.
DP-1550L	LID ONLY FOR 7.5" BOWL,	CLEAR	300 EA.
DP-1551L	LID ONLY FOR 9" BOWL	CLEAR	150 EA.
DP-1552L	LID ONLY FOR 10.75" BOW	CLEAR	50 EA.

**(PLASTIC)**  
SOLD INCASE PACKS OF 3,000 PIECE (10 PACKS OF 300- 100 PIECE FORKS, 100 PIECE SPOONS, 100 PIECE KNIVES).  
DP-350C CLEAR  
DP-350W WHITE



**DISPOSABLE SERVING PIECES (PLASTIC)**  
SOLD IN CASE PACKS ONLY!

DP-600	LADLE	5 OZ.	CLEAR	12 EA.
DP-601	TONG	6.5" L.	BLACK	144 EA.
DP-602	TONG	12" L.	CLEAR	48 EA.
DP-603BK	LADLE	2 OZ.	BLACK	48 EA.
DP-603C	LADLE	2 OZ.	CLEAR	12 EA.
DP-604	SALAD TONG	11.5" L.	CLEAR	6 EA.
DP-606BK	FORK AND SPOON SET	9.5" L.	BLACK	144 SET
DP-606C	FORK AND SPOON SET	9.5" L.	CLEAR	144 SET
DP-606W	FORK AND SPOON SET	9.5" L.	WHITE	144 SET

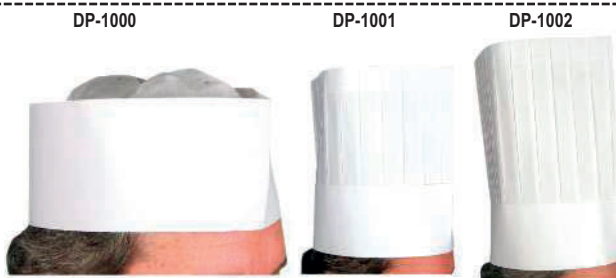

**DISPOSABLE CHEF HATS**

SINCE THEY'RE MADE OF PAPER, THEY ARE PERFECT FOR ANY FUNDRAISER OR SPECIAL EVENT AND AN EXCELLENT WAY TO GET KIDS MORE INVOLVED IN THE KITCHEN.

DP-1000	3" HIGH	PACK/100
DP-1001	9" HIGH	PACK/10
DP-1002	12" HIGH	PACK/10

## PROFESSIONAL APPAREL

POLY-COTTON BLEND

MADE FROM A BLEND OF 65/35 COTTON-POLY BLEND.



**BISTRO APRON, HALF LENGTH, 2 POCKETS**  
SOLD IN CASE PACK OF 12.

AP-435BL	BLACK	28" L. X 19" W.
AP-435W	WHITE	28" L. X 19" W.

**CHEF JACKET, UNIVERSAL FIT, BRIGHT WHITE**  
THEY ARE DOUBLE BREASTED WITH A THERMOMETER/PEN POCKET AND A CHEST POCKET. SOLD IN CASE PACK OF 12.

CHJ-300W	SMALL
CHJ-301W	MEDIUM
CHJ-302W	LARGE
CHJ-303W	X-LARGE
CHJ-304W	2XL
CHJ-305W	3XL

**CHEF PANTS, UNIVERSAL FIT, HOUNDSTOOTH**  
THEY ARE RELAXED FIT WITH DRAWSTRING ELASTIC WAISTBAND AND TWO SIDE-SEAM POCKETS. SOLD IN CASE PACK OF 12.

CHP-410	SMALL
CHP-411	MEDIUM
CHP-412	LARGE
CHP-413	X-LARGE
CHP-414	2XL

**PILLBOX HAT, VENTILATED**

FEATURE A COOL MESH TOP PANEL ALONG WITH AN ELASTIC BAND ON THE BACK TO ALLOW FOR A SECURE FIT. SOLD IN CASE PACK OF 48.

CHH-300BL	REGULAR, BLACK
CHH-301BL	X-LARGE, BLACK
CHH-300W	REGULAR, WHITE
CHH-301W	X-LARGE, WHITE

**CHEF SHIRT, LIGHTWEIGHT, UNIVERSAL FIT (POLY-COTTON BLEND)**  
THE SHIRTS ARE SHORT SLEEVED AND HAVE A CHEST POCKET WITH SNAP-BUTTON FASTENERS. SOLD IN CASE PACK OF 12.

CHS-400BL	SMALL, BLACK
CHS-401BL	MEDIUM, BLACK
CHS-402BL	LARGE, BLACK
CHS-403BL	X-LARGE, BLACK
CHS-404BL	2XL, BLACK
CHS-405BL	3XL, BLACK
CHS-406BL	4XL, BLACK
CHS-400W	SMALL, WHITE
CHS-401W	MEDIUM, WHITE
CHS-402W	LARGE, WHITE
CHS-403W	X-LARGE, WHITE
CHS-404W	2XL, WHITE
CHS-405W	3XL, WHITE
CHS-406W	4XL, WHITE

# TABLE LINENS



**DISPOSABLE TABLE SKIRTING (PLASTIC)**  
 AVAILABLE IN THE FOLLOWING COLORS: BLACK(BK), BURGUNDY(BU), HARVEST YELLOW(HY), HUNTER GREEN(HG), HOT PINK(HP), IVORY(IV), KELLY GREEN(KG), LAVENDER(LV), LIGHT BLUE(LB), MINT GREEN(MG), METALLIC SILVER(SI), METALLIC GOLD(MGO), NAVY BLUE(NB), PEACH(PE), PINK(PK), RED(RD), ROYAL BLUE(BL), ROYAL PURPLE(RP), TANGERINE(TG), TEAL(TE), WHITE(WH), YELLOW(YE). SPECIFY BOTH THE COLOR AND COLOR CODE WHEN ORDERING. SOLD IN CASE PACKS ONLY!

DP-730 29" x 14' RECTANGULAR TABLE SKIRTING

CASE PACK 6 EACH



**DISPOSABLE BANQUET ROLLS (PLASTIC)**  
 AVAILABLE IN THE FOLLOWING COLORS: AQUA(AQ), BLACK(BK), BURGUNDY(BU), CLEAR(CL), HUNTER GREEN(HG), HOT PINK(HP), HARVEST YELLOW(HY), IVORY(IV), KELLY GREEN(KG), LIGHT BLUE(LB), LAVENDER(LV), MELON(ME), METALLIC GOLD(MGO), NAVY BLUE(NB), PINK(PK), TEAL(TE), RED(RD), TANGERINE(TG), WHITE(WH), YELLOW(YE), ROYAL BLUE(BL), ROYAL PURPLE(RP), METALLIC SILVER(SI). SPECIFY BOTH THE COLOR AND COLOR CODE WHEN ORDERING. SOLD IN CASE PACKS ONLY!

DP-700 40" x 100' BANQUET ROLLS

CASE PACK 4 ROLLS

**FINISHED PREPACKAGED TABLECLOTHS, SOLID LINEN COLORS**

THESE VINYL TABLECLOTHS ARE PRE-PACKED BY THE CASE OF 24. THEY ARE FINISHED ON THE EDGES AND HAVE A FLANNEL BACK.

52" x 52": 2 WHITE, 1 MAROON, 1 NAVY, 2 GREEN  
 52" x 70": 2 WHITE, 2 MAROON, 2 NAVY, 4 GREEN

60" ROUND: 2 WHITE, 1 MAROON, 1 NAVY, 2 GREEN  
 TCV-4704



**DISPOSABLE WHITE AISLE RUNNER (PLASTIC)**

PLASTIC RESISTS TEARING AND PUNCTURING FROM HEELS. SOLD IN CASE PACKS ONLY!

DP-950 36" x 50' 12 EACH  
 DP-951 36" x 75' 8 EACH  
 DP-952 36" x 100' 6 EACH  
 DP-953 36" x 125' 6 EACH  
 DP-954 36" x 150' 5 EACH  
 DP-955 36" x 300' 2 EACH



**DISPOSABLE WHITE FLORAL AISLE RUNNER (PLASTIC)**

THIS RUNNER IS MADE FROM A TEXTURED FABRIC THAT LOOKS AND FEELS LIKE CLOTH. RESISTS TEARING AND PUNCTURING FROM HEELS. SOLD IN CASE PACKS ONLY!

DP-900 36" x 50' 6 EACH  
 DP-901 36" x 75' 5 EACH  
 DP-902 36" x 100' 4 EACH  
 DP-903 36" x 125' 2 EACH  
 DP-904 36" x 150' 2 EACH

**DISPOSABLE TABLE COVERS (PLASTIC)**

RECTANGULAR AVAILABLE IN THE FOLLOWING COLORS: BLACK(BK), BURGUNDY(BU), CLEAR(CL), HARVEST YELLOW(HY), HUNTER GREEN(HG), IVORY(IV), KELLY GREEN(KG), LAVENDER(LV), LIGHT BLUE(LB), MELON(ME), METALLIC SILVER(SI), METALLIC GOLD(MGO), NAVY BLUE(NB), NEON BLUE(NBL), NEON GREEN(NGR), NEON ORANGE(TG), NEON PINK(PHP), PEACH(PE), PINK(PK), RED(RD), ROYAL BLUE(BL), ROYAL PURPLE(RP), TEAL(TE), WHITE(WH), YELLOW(YE).  
 ROUND AVAILABLE IN THE FOLLOWING COLORS: BLACK(BK), BURGUNDY(BU), HARVEST YELLOW(HY), HUNTER GREEN(HG), HOT PINK(HP), IVORY(IV), KELLY GREEN(KG), LAVENDER(LV), LIGHT BLUE(LB), METALLIC SILVER(SI), NAVY BLUE(NB), PINK(PK), RED(RD), ROYAL BLUE(BL), ROYAL PURPLE(RP), TANGERINE(TG), TEAL(TE), WHITE(WH), YELLOW(YE). SPECIFY BOTH THE COLOR AND COLOR CODE WHEN ORDERING.

DP-710 RECTANGULAR 54" x 108" 48 EACH  
 DP-720 ROUND 84" DIA. 48 EACH  
 DP-722 CLIPS, WHITE 144 EACH  
 DP-723 CLIPS, CLEAR 144 EACH  
 DP-724 CLIPS, CLEAR 100 EACH



**UPHOLSTERY TEXTURED GRAIN EXPANDED VINYL**

THIS UPHOLSTERY TEXTURED GRAIN EXPANDED VINYL IS SOLD IN A ROLL OF 54" X 15 YARDS. IT IS DESIGNED FOR USE AS A TABLECLOTH IN HOMES OR TO REPLACE ANY SEAT PADS WHERE NEEDED. IT FEELS LIKE SOFT LEATHER AND CAN BE ROLLED OUT FLAT.

UV-110 BRIGHT RED  
 UV-111 MAROON  
 UV-121 DARK BLUE  
 UV-151 SADDLE  
 UV-160 BLACK  
 UV-170 PURE WHITE  
 UV-250 BUCKSKIN TAN  
 UV-271 OFF WHITE  
 UV-330 DARK GREEN  
 UV-381 SLATE GREY  
 UV-563 BLACK OXEN



**FINISHED PREPACKAGED TABLECLOTHS, CHECK RED**

THESE VINYL TABLECLOTHS ARE PRE-PACKED BY THE CASE OF 24. THEY ARE FINISHED ON THE EDGES AND HAVE A FLANNEL BACK. IT'S DURABLE CONSTRUCTION IS DESIGNED FOR USE WITH SMOOTH EASY CLEAN SURFACE.

TCV-4720 52" X 52" 24 PACK  
 TCV-4721 52" X 70" 24 PACK  
 TCV-4722 52" X 90" 24 PACK  
 TCV-4723 60" RD 24 PACK  
 TCV-4701 ALL SIZE 24 PACK  
 (8)-52" x 52, (8)- 52" x 70", (8)-60" RD



**11 ROLL METAL DISPLAY RACK**  
 THIS METAL MERCHANDISING RACK IS A GREAT TOOL TO DISPLAY VINYL TABLECLOTH ROLLS AT STORE LOCATIONS. THIS DISPLAY RACK CAN HOLD UP TO 11 ROLLS. RACK FEATURES 62" WIDE CUTTING GUIDE AND BUILT IN 40" H MEASURING TOOL TO MAKE CUTTING ROLLS EASY FOR CUSTOM SIZE ORDERS. RACK IS EASY TO ASSEMBLE AND SOLD COMPLETE. RACK FEATURES SIGN SLOT AND 11 REMOVEABLE METAL RODS. SHIPS UNASSEMBLED. 67 LBS.  
 RCK-0911 62" W. x 15" D. x 71" H.

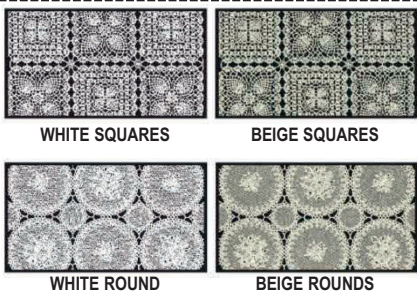

**LACE VINYL ROLLS**  
 THIS VINYL LACE HAS THE REAL LOOK OF LACE, BUT IS MADE OF DURABLE VINYL. THE ELEGANT LOOK OF LACE AT A VALUE PRICE. PLEASE NOTE THE BLACK BACKGROUND FOR THE PICTURE IS TO SHOW THE PATTERN MORE CLEARLY.

VL-0100 WHITE SQUARES 54" x 22 YDS  
 VL-0110 WHITE SQUARES 20" x 22 YDS  
 VL-0111 BEIGE SQUARES 54" x 22 YDS  
 VL-0114 BEIGE SQUARES 20" x 22 YDS  
 VL-0112 WHITE ROUND 54" x 22 YDS  
 VL-0116 WHITE ROUND 20" x 22 YDS  
 VL-0113 BEIGE ROUND 54" x 22 YDS  
 VL-0115 BEIGE ROUND 20" x 22 YDS



**CLEAR VINYL ROLLS**  
 THESE CLEAR VINYL HEAVY GAUGE ROLLS, COME IN A VARIETY OF THICKNESSES. THEY ARE PERFECT FOR TABLE COVERINGS. WEATHER RESISTANT, AND FOR OUTDOOR USE.

VWC-1299 12 GAUGE CLEAR 54" W. X 25 YD ROLL  
 VWC-1699 16 GAUGE CLEAR 54" W. x 15 YD ROLL  
 VWC-2099 20 GAUGE CLEAR 54" W. x 15 YD ROLL  
 VWC-0669 6 GAUGE CLEAR 72" W. x 25 YD ROLL  
 VWC-0118 5 GAUGE FLORAL PRINT 54" W. x 50 YD ROLL

**FINISHED PREPACKAGED TABLECLOTHS, CHECK PATTERN**

THESE VINYL TABLECLOTHS ARE PRE-PACKED BY THE CASE OF 36. THEY ARE FINISHED ON THE EDGES AND HAVE A FLANNEL BACK.  
 TCV-4562  
 52" x 52": 3 RED, 1 NAVY, 1 GREEN, 1 YELLOW  
 52" x 70": 6 RED, 2 NAVY, 2 GREEN, 2 YELLOW  
 52" x 90": 6 RED, 2 NAVY, 1 GREEN, 1 YELLOW  
 60" ROUND: 4 RED, 2 NAVY, 1 GREEN, 1 YELLOW



**UNSUPPORTED "OIL CLOTH" BULK ROLL VINYL**  
 THIS "OIL CLOTH" IS A TABLECLOTH WITH NO BACKING. IT IS SOLD IN A ROLL OF 54" X 20 YARDS.

UBV-0123 GINGHAM RED  
 UBV-0124 GINGHAM NAVY  
 UBV-0133 STARNITE BLACK  
 UBV-0143 TAVERN CHECK RED  
 UBV-0144 TAVERN CHECK GREEN  
 UBV-0145 TAVERN CHECK YELLOW  
 UBV-0158 CHESS CHECK RED  
 UBV-0188 CAMOUFLAGE  
 UBV-0196 LINEN MAROON  
 UBV-0197 LINEN TAN  
 UBV-0195 LINEN WHITE  
 UBV-0198 LINEN FOREST GREEN  
 UBV-0301 GLOSS RED  
 UBV-0302 GLOSS GREEN  
 UBV-0303 GLOSS BLUE



**COMMERCIAL GRADE TABLECLOTH WITH NON-WOVEN PP BACKING**  
 THIS NON-WOVEN PP BACKING TABLECLOTH IS A COMMERCIAL GRADE AND SOLD IN A ROLL OF 54" X 15 YARDS. THE BACKING IS NON FRAY AND IS WATERPROOF, OIL-PROOF AND DESIGNED FOR EXTENDED USE INDOORS OR OUTDOORS.

TCV-0301 COFFEE CAFE  
 TCV-0302 FARM COUNTRY  
 TCV-0303 BEIGE DECOR  
 TCV-0304 TEA TIME  
 TCV-0305 APPLE QUILT  
 TCV-0358 CHESS CHECK RED

# TABLE LINENS

## DELUXE X-HEAVY FLANNEL BACK TABLECLOTH BULK ROLL VINYL

THIS FLANNEL BACKING TABLECLOTH IS SOLD IN A ROLL OF 54" X 15 YARDS. IT CAN BE USED IN HOMES, RESTAURANTS, HOTELS, BANQUET FACILITIES, CAMP GROUNDS, OR EVEN SPORTS ARENAS. IT'S DURABLE CONSTRUCTION IS WATERPROOF, OIL-PROOF AND DESIGNED FOR EXTENDED USE INDOORS OR OUTDOORS.

TCV-0201 GREEN LEAVES	TCV-0221 YELLOW FLORAL	TCV-0241 TAVERN CHECK HUNTER	TCV-0259 CHECK CHESS ORCHID	TCV-0281 ROSE LEAF
TCV-0202 FLOWER QUILT	TCV-0223 CHILDREN'S ANIMALS	TCV-0242 TAVERN CHECK NAVY	TCV-0260 MOIRE ROSE	TCV-0288 PARTY TIME
TCV-0208 WHITE LEMONS	TCV-0224 LINEN FOREST GREEN	TCV-0243 TAVERN CHECK RED	TCV-0261 MOIRE BLUE	TCV-0290 WHITE LACE
TCV-0209 BLUE LEMONS	TCV-0226 TROPICAL FLORAL	TCV-0244 TAVERN CHECK BLUE	TCV-0262 MOIRE GREEN	TCV-0291 BLUE LACE
TCV-0210 MAROON LEMONS	TCV-0229 SUNFLOWER BLUE	TCV-0245 TAVERN CHECK YELLOW	TCV-0264 MOIRE WHITE	TCV-0292 GREEN LACE
TCV-0211 DESIGNER FLORAL ROSE	TCV-0230 SUNFLOWER WHITE	TCV-0246 FRUIT	TCV-0266 AZTEC SUN	TCV-0293 BEIGE LACE
TCV-0212 DESIGNER FLORAL ORCHID	TCV-0231 DAWN MEADOW	TCV-0247 TAVERN CHECK BROWN	TCV-0267 AZTEC MIST	TCV-0294 LINEN NAVY
TCV-0213 DESIGNER FLORAL GREEN	TCV-0232 STRAWBERRY WHITE	TCV-0248 CHESS CHECK BLACK	TCV-0268 BANDANA RED	TCV-0295 LINEN WHITE
TCV-0214 DESIGNER FLORAL YELLOW	TCV-0233 PASTEL BOUQUET	TCV-0250 GINGHAM RED	TCV-0269 CHESS CHECK YELLOW	TCV-0296 LINEN BLUE
TCV-0215 DESIGNER SHAPE ORANGE	TCV-0234 APPLES	TCV-0251 GINGHAM BLUE	TCV-0270 WOODGRAIN	TCV-0297 LINEN BEIGE
TCV-0216 DESIGNER SHAPE GREEN	TCV-0235 GREEN IVY	TCV-0253 GINGHAM HUNTER	TCV-0271 FLOWERS & FRUIT	TCV-0298 LINEN MAROON
TCV-0217 FALLING LEAVES	TCV-0236 WHITE FLORAL EMBOSS	TCV-0256 CHESS CHECK NAVY	TCV-0275 SEA SHELLS	TCV-0299 ROSE LACE
TCV-0218 HALLOWEEN	TCV-0238 DAMASK WHITE	TCV-0257 CHESS CHECK GREEN	TCV-0277 USA FLAGS BLUE	TCV-0300 LINEN LIGHT GREEN
TCV-0220 ROSE FLORAL	TCV-0239 WILDFLOWERS	TCV-0258 CHESS CHECK RED	TCV-0278 USA FLAGS BEIGE	

# TABLECLOTHS

## 100% SPUN FORTREL POLYESTER COLOR CHART FABRIC WIDTH - 72"



**TABLECLOTHS (100% SPUN FORTREL POLYESTER)**

100% SPUN FORTREL POLYESTER FEATURES THE FEEL AND TEXTURE OF COTTON WITH THE EASE AND DURABILITY OF POLYESTER. AN INDUSTRY FAVORITE FOR DURABILITY AND EVERYDAY USE, THIS FABRIC IS AVAILABLE IN 72" FABRIC WIDTH. PLEASE NOTE THAT CUSTOM PANEL REQUESTS FOR 90" PANELS ARE AVAILABLE UPON REQUEST IN WHITE, IVORY, AND BLACK. PLEASE CALL FOR CUSTOM QUOTE. ANY FABRIC SELECTIONS LARGER THAN 72" WILL FEATURE A SEAM. PLEASE NOTE THAT ALL TABLECLOTHS MUST BE ORDERED IN CASE PACK INCREMENTS OF 12 EACH. ASSORTED COLORS AVAILABLE AS SEEN ON COLOR CHART. PLEASE SPECIFY COLOR WHEN ORDERING. MATCHING NAPKINS AVAILABLE.

TCNPC-4830	70" ROUND	SELECT COLOR/#
TCNPC-4830W	70" ROUND	COLOR: WHITE ONLY
TCNPC-4831	84" ROUND	SELECT COLOR/#
TCNPC-4831W	84" ROUND	COLOR: WHITE ONLY
TCPC-4851	90" ROUND	SELECT COLOR/#
TCPC-4851W	90" ROUND	COLOR: WHITE ONLY
TCPC-4852	96" ROUND	SELECT COLOR/#
TCPC-4852W	96" ROUND	COLOR: WHITE ONLY
TCNPC-4832	102" ROUND	SELECT COLOR/#
TCNPC-4832W	102" ROUND	COLOR: WHITE ONLY
TCNPC-4847	108" ROUND	SELECT COLOR/#
TCNPC-4847W	108" ROUND	COLOR: WHITE ONLY
TCNPC-4848	120" ROUND	SELECT COLOR/#
TCNPC-4848W	120" ROUND	COLOR: WHITE ONLY
TCNPC-4849	132" ROUND	SELECT COLOR/#
TCNPC-4849W	132" ROUND	COLOR: WHITE ONLY
TCPC-4857	54" SQUARE	SELECT COLOR/#
TCPC-4857W	54" SQUARE	COLOR: WHITE ONLY
TCNPC-4872	72" SQUARE	SELECT COLOR/#
TCNPC-4872W	72" SQUARE	COLOR: WHITE ONLY
TCNPC-4873	84" SQUARE	SELECT COLOR/#
TCNPC-4873W	84" SQUARE	COLOR: WHITE ONLY
TCNPC-4860	90" SQUARE	SELECT COLOR/#
TCNPC-4860W	90" SQUARE	COLOR: WHITE ONLY
TCNPC-4875	120" SQUARE	SELECT COLOR/#
TCNPC-4875W	120" SQUARE	COLOR: WHITE ONLY
TCNPC-4876	132" SQUARE	SELECT COLOR/#
TCNPC-4876W	132" SQUARE	COLOR: WHITE ONLY
TCNPC-4866	60" x 120" RECTANGULAR	SELECT COLOR/#
TCNPC-4866W	60" x 120" RECTANGULAR	COLOR: WHITE ONLY
TCNPC-4877	60" x 144" RECTANGULAR	SELECT COLOR/#
TCNPC-4877W	60" x 144" RECTANGULAR	COLOR: WHITE ONLY
TCPC-4867	72" x 120" RECTANGULAR	SELECT COLOR/#
TCPC-4867W	72" x 120" RECTANGULAR	COLOR: WHITE ONLY
TCNPC-4869	90" x 132" RECTANGULAR	SELECT COLOR/#
TCNPC-4869W	90" x 132" RECTANGULAR	COLOR: WHITE ONLY
TCNPC-4870	90" x 156" RECTANGULAR	SELECT COLOR/#
TCNPC-4870W	90" x 156" RECTANGULAR	COLOR: WHITE ONLY
TCNPC-4879	108" x 132" RECTANGULAR	SELECT COLOR/#
TCNPC-4879W	108" x 132" RECTANGULAR	COLOR: WHITE ONLY
TCNPC-4880	108" x 156" RECTANGULAR	SELECT COLOR/#
TCNPC-4880W	108" x 156" RECTANGULAR	COLOR: WHITE ONLY



DYE LOT COLOR OF FABRIC MAY VARY FROM ORDER TO ORDER.



### SHIRRED PLEAT TABLE SKIRTING (100% SPUN FORTREL POLYESTER)

100% SPUN FORTREL POLYESTER FEATURES THE FEEL AND TEXTURE OF COTTON WITH THE EASE AND DURABILITY OF POLYESTER. AN INDUSTRY FAVORITE FOR DURABILITY AND EVERYDAY USE, VELCRO CLIPS ARE INCLUDED WITH SKIRTING PANELS PLEASE NOTE THAT ALL SHIRRED SKIRTING IS 29" IN HEIGHT AND MUST BE ORDERED IN CASE PACK INCREMENTS OF 12 EACH, BY THE SAME SIZE, COLOR, FABRIC SELECTIONS. PLEASE SPECIFY COLOR WHEN ORDERING. MATCHING TABLECLOTHS AND NAPKINS AVAILABLE.



### BOX PLEAT TABLE SKIRTING (100% SPUN FORTREL POLYESTER)

100% SPUN FORTREL POLYESTER FEATURES THE FEEL AND TEXTURE OF COTTON WITH THE EASE AND DURABILITY OF POLYESTER. AN INDUSTRY FAVORITE FOR DURABILITY AND EVERYDAY USE, THIS THICK BOX DESIGN GIVES THE TABLE A PLEATED AND FINISHED LOOK. VELCRO CLIPS ARE INCLUDED WITH SKIRTING PANELS. PLEASE NOTE THAT ALL BOX PLEAT IS 29" IN HEIGHT AND MUST BE ORDERED IN CASE PACK INCREMENTS OF 12 EACH, BY THE SAME SIZE, COLOR, FABRIC SELECTIONS. PLEASE SPECIFY COLOR WHEN ORDERING. MATCHING TABLECLOTHS AND NAPKINS AVAILABLE.



### LUNCHEON NAPKINS (100% SPUN FORTREL POLYESTER)

ASSORTED COLORS LISTED ABOVE. PLEASE SPECIFY COLOR WHEN ORDERING. SOLD IN CASE PACKS OF 12 DOZENS ONLY! NAPKINS SHOWN ARE FOR PHOTOGRAPHY ONLY. COLORS MAY VARY.

	SIZE	COLOR	CASE PACK
TCNPC-5017	17" SQUARE	SELECT COLOR/#	PKG 1 DOZ.
TCNPC-5017W	17" SQUARE	COLOR: WHITE ONLY	PKG 1 DOZ.
TCNPC-5020	20" SQUARE	SELECT COLOR/#	PKG 1 DOZ.
TCNPC-5020W	20" SQUARE	COLOR: WHITE ONLY	PKG 1 DOZ.

TSP-2000-3	9 FT x 29" H.	FOR 3 SIDES OF 4 FT TABLE	SELECT COLOR/#
TSP-2000-4	13 FT x 29" H.	FOR 4 SIDES OF 4 FT TABLE	SELECT COLOR/#
TSP-2001-3	11 FT x 29" H.	FOR 3 SIDES OF 6 FT TABLE	SELECT COLOR/#
TSP-2001-4	17 FT x 29" H.	FOR 4 SIDES OF 6 FT TABLE	SELECT COLOR/#
TSP-2002-3	13 FT x 29" H.	FOR 3 SIDES OF 8 FT TABLE	SELECT COLOR/#
TSP-2002-4	21 FT x 29" H.	FOR 4 SIDES OF 8 FT TABLE	SELECT COLOR/#
TSP-2003	8 FT x 29" H.	FOR A 30" ROUND TABLE	SELECT COLOR/#
TSP-2004	9.5 FT x 29" H.	FOR A 36" ROUND TABLE	SELECT COLOR/#
TSP-2005	13 FT x 29" H.	FOR A 48" ROUND TABLE	SELECT COLOR/#
TSP-2006	16 FT x 29" H.	FOR A 60" ROUND TABLE	SELECT COLOR/#
TSP-2007	19 FT x 29" H.	FOR A 72" ROUND TABLE	SELECT COLOR/#
TSP-2008	16 FT x 29" H.	FOR A 48" SQUARE TABLE	SELECT COLOR/#
TSP-2009	20 FT x 29" H.	FOR A 60" SQUARE TABLE	SELECT COLOR/#
TSP-2010	24 FT x 29" H.	FOR A 72" SQUARE TABLE	SELECT COLOR/#

TSP-2100-3	9 FT x 29" H.	FOR 3 SIDES OF 4 FT TABLE	SELECT COLOR/#
TSP-2100-4	13 FT x 29" H.	FOR 4 SIDES OF 4 FT TABLE	SELECT COLOR/#
TSP-2101-3	11 FT x 29" H.	FOR 3 SIDES OF 6 FT TABLE	SELECT COLOR/#
TSP-2101-4	17 FT x 29" H.	FOR 4 SIDES OF 6 FT TABLE	SELECT COLOR/#
TSP-2102-3	13 FT x 29" H.	FOR 3 SIDES OF 8 FT TABLE	SELECT COLOR/#
TSP-2102-4	21 FT x 29" H.	FOR 4 SIDES OF 8 FT TABLE	SELECT COLOR/#
TSP-2103	8 FT x 29" H.	FOR A 30" ROUND TABLE	SELECT COLOR/#
TSP-2104	9.5 FT x 29" H.	FOR A 36" ROUND TABLE	SELECT COLOR/#
TSP-2105	13 FT x 29" H.	FOR A 48" ROUND TABLE	SELECT COLOR/#
TSP-2106	16 FT x 29" H.	FOR A 60" ROUND TABLE	SELECT COLOR/#
TSP-2107	19 FT x 29" H.	FOR A 72" ROUND TABLE	SELECT COLOR/#
TSP-2108	16 FT x 29" H.	FOR A 48" SQUARE TABLE	SELECT COLOR/#
TSP-2109	20 FT x 29" H.	FOR A 60" SQUARE TABLE	SELECT COLOR/#
TSP-2110	24 FT x 29" H.	FOR A 72" SQUARE TABLE	SELECT COLOR/#



### STANDARD TABLE SKIRTING CLIPS (CLEAR PLASTIC)

STANDARD TABLE SKIRTING CLIPS, FITS 3/4" TABLE LIP. THESE STANDARD TABLE SKIRTING CLIPS HAVE A VELCRO FASTENER AND ARE PERFECT FOR SECURING TABLE SKIRTING FOR TABLES WITH A 3/4" TABLE LIP. SOLD AS A PACKAGE OF 100. TRS-4801 FITS 3/4" TABLE LIP

# TABLECLOTHS, HIGH CHAIRS, & GARMENT RACKS

## VALUE-TEX 100% POLYESTER TABLECLOTHS & TABLE SKIRTING & TABLE BOX COVER & NAPKINS

THESE ARE MADE OF FASHIONABLE, VERSATILE, AND DURABLE 100% POLYESTER THAT IS CERTIFIED FLAME RETARDANT! THE FABRIC IS AVAILABLE IN 132" FABRIC WIDTH PANEL WHICH ALLOWS NO SEAMS FOR BEAUTIFUL TABLETOP PRESENTATIONS. THE COMPLETE SWATCH KIT IS AVAILABLE ONLINE AT WWW.CATERERSWAREHOUSE.COM. IT FEATURES A LARGE SELECTION OF COLORS TO CHOOSE FROM. THIS PRODUCT IS GREAT FOR EVERYDAY APPLICATIONS AND WITHSTANDS DAILY LAUNDERING. SOLD BY THE DOZEN OF THE SAME COLOR ONLY!

### Value-Tex Polyester

100% Polyester  
Fabric Width - 132"  
Certified Flame Retardant



### TABLECLOTHS

Item	Size	Case Pack
TCP-7502	90" ROUND	1 DOZ.
TCP-7503	96" ROUND	1 DOZ.
TCP-7504	102" ROUND	1 DOZ.
TCP-7505	108" ROUND	1 DOZ.
TCP-7506	114" ROUND	1 DOZ.
TCP-7508	132" ROUND	1 DOZ.
TCP-7510	54" SQUARE	1 DOZ.
TCP-7512	72" SQUARE	1 DOZ.
TCP-7513	84" SQUARE	1 DOZ.
TCP-7514	90" SQUARE	1 DOZ.
TCP-7516	120" SQUARE	1 DOZ.
TCP-7517	132" SQUARE	1 DOZ.
TCP-7518	60" x 120" RECT.	1 DOZ.
TCP-7519	70" x 120" RECT.	1 DOZ.
TCP-7521	90" x 132" RECT.	1 DOZ.
TCP-7522*	90" x 156" RECT.	1 DOZ.
TCP-7523*	108" x 132" RECT.	1 DOZ.
TCP-7524*	108" x 156" RECT.	1 DOZ.

### SHIRRED PLEAT SKIRTING

Item	Size	Use	Case Pack
TSP-6000-3	9 FT X 29" H.	FOR 3 SIDES OF 4 FT TABLE	12 EACH
TSP-6000-4	13 FT X 29" H.	FOR 4 SIDES OF 4 FT TABLE	12 EACH
TSP-6001-3	11 FT X 29" H.	FOR 3 SIDES OF 6 FT TABLE	12 EACH
TSP-6001-4	17 FT X 29" H.	FOR 4 SIDES OF 6 FT TABLE	12 EACH
TSP-6002-3	13 FT X 29" H.	FOR 3 SIDES OF 8 FT TABLE	12 EACH
TSP-6002-4	21 FT X 29" H.	FOR 4 SIDES OF 8 FT TABLE	12 EACH
TSP-6003	8 FT X 29" H.	FOR 30" ROUND TABLE	12 EACH
TSP-6004	9.5 FT X 29" H.	FOR 36" ROUND TABLE	12 EACH
TSP-6005	13 FT X 29" H.	FOR 48" ROUND TABLE	12 EACH
TSP-6006	16 FT X 29" H.	FOR 60" ROUND TABLE	12 EACH
TSP-6007	19 FT X 29" H.	FOR 72" ROUND TABLE	12 EACH
TSP-6008	16 FT X 29" H.	FOR 48" SQUARE TABLE	12 EACH
TSP-6009	20 FT X 29" H.	FOR 60" SQUARE TABLE	12 EACH
TSP-6010	24 FT X 29" H.	FOR 72" SQUARE TABLE	12 EACH

### NAPKINS

Item	Size	Case Pack
TCNP-7600	10" SQUARE	12 DOZ.
TCNP-7601	17" SQUARE	12 DOZ.
TCNP-7602	20" SQUARE	12 DOZ.



### DOUBLE SIDED BOOSTER SEAT WITH STRAP (PLASTIC)

FEATURES INCLUDED CONTOURED SEAT, HIGH SIDES, WIDE SQUARE BASE AND NON-SKID SURFACE, DESIGNED TO KEEP CHILD SAFE AND COMFORTABLE WHILE SEATED AT A TABLE. DURABLE POLYETHYLENE WILL NEVER DENT, CHIP, RUST OR BREAK. DISHWASHER SAFE. AVAILABLE BLACK OR BROWN..  
BS-850 12" W. x 11 7/8" D x 9 1/4" H.

### COAT CHECK TAGS

COAT CHECK TAGS, 3 PART CHECK WITH PERFORATIONS FOR EASY SEPARATION. SPECIFY COLOR: BLUE(BL), PINK(PK), WHITE(WT), OR YELLOW(YL).



AC-1663  
500 PER BOX

### CHROMEPLATE HANGERS

HEAVY DUTY.

SOLD IN CASE PACKS OF 24.  
GRH-16



### HIGH CHAIRS (RUBBERWOOD)

MADE FROM A HIGH QUALITY, SMOOTH FINISH SOLID RUBBERWOOD, HEAVY DUTY EASY TO ASSEMBLE. STRAPS ARE PRE-ATTACHED. STACKABLE.  
20 1/8" W. X 19 3/8" D. X 29 1/4" H., SEAT IS AT 20" H.

CHR-2785 NATURAL  
CHR-2787 MAHOGANY  
CHR-2788 WALNUT



### HEAVY HIGH CHAIR (PLASTIC)

AVAILABLE WITH WHEELS AND A CONVENIENT HANDLE FOR EASY MANEUVERABILITY. EASY TO USE TRAY THAT CAN BE REMOVED WITH ONE HAND. HIGH CHAIR SOLD COMPLETE WITH TRAY. ADDITIONAL TRAYS SOLD SEPARATELY!

CHR-2800 HIGH CHAIR  
TRY-2800 TRAY ONLY

### MAPLE HARDWOOD HANGERS (MAPLE HARDWOOD)



HEAVY DUTY CHROME HANGERS. CASE PACK OF 1 DOZEN.  
AC-WCH-1



### GARMENT RACKS (CHROMEPLATE)

UNITS ARE FULLY COLLAPSIBLE AND GREAT FOR EASY STORAGE AND TRANSPORT. SOLD COMPLETE WITH NO NUTS OR BOLTS TO LOSE DURING SET UP OR BREAKDOWN.



GR-13287 UNIVERSAL "Z" STACKING ROLLING RACK

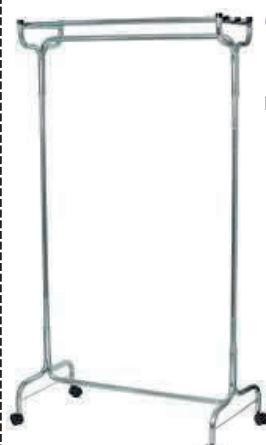

### GARMENT RACKS WITH CASTERS (CHROME)

THESE GARMENT RACKS FEATURE 1" CHROME TUBING. THE GARMENT RACKS INCLUDE CASTERS FOR EASY PORTABILITY.

GR-6036 36" WIDE  
GR-6048 48" WIDE

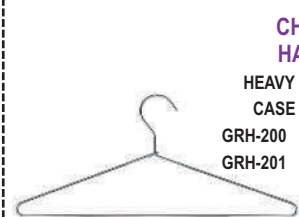

### CHROMED HANGERS

HEAVY DUTY. SOLD IN CASE PACKS ONLY.  
GRH-200 OPEN HOOK  
GRH-201 CLOSED HOOK

### COAT CHECK TAGS

THIS SET INCLUDES 2 EACH OF THE NUMBER SEQUENCE.

AC-1660 NO. 1 TO 100 SET  
AC-1661 NO. 101 TO 200 SET  
AC-1662 NO. 201 TO 300 SET



# CHAIRS



CHR-8700

CHR-8701

CHR-8702

CHR-8703

CHR-8704



### KD CHIAVARI RESIN CHAIRS

- SOLD IN CASE PACK OF 16 ONLY!
- \* CHAIRS ARE FURNISHED KD - ASSEMBLY REQUIRED
- \* CUSHIONS SOLD SEPARATELY
- \* STACK UP TO 7 CHAIRS HIGH
- \* 3 YEAR LIMITED MANUFACTURER WARRANTY

CHR-8710	WHITE C	36" H. x 15" W. x 19" DEPTH
CHR-8711	BLACK	36" H. x 15" W. x 19" DEPTH
CHR-8712	CLEAR	36" H. x 15" W. x 19" DEPTH

### CHIAVARI CUSHIONS

- SOLD IN CASE PACK OF 5 ONLY!
- \* 2" FOAM CUSHIONS ARE DESIGNED FOR EXTRA COMFORT
- \* CUSHION ATTACHES WITH 2 VELCRO TIE STRAPS

CHR-5010	WHITE
CHR-5011	BLACK
CHR-5012	IVORY



CHR-8705

CHR-8706

### CHIAVARI STACK CHAIRS WITH CUSHION

- SOLD IN CASE PACK OF 16 EACH.
- FEATURES:
- \* LONG GRAIN HARD WOOD SEAT
- \* HIGH DENSITY, FLAME RETARDANT 2" FOAM CUSHION INCLUDED
- \* DURABLE STEEL FLAT SOCKET CAP SCREW AND LOCKNUT
- \* PRE-ASSEMBLED
- \* STEEL FLAT SOCKET CAP SCREW AND LOCKNUT
- \* STURDY WOOD SEAT IS WIDER FOR BETTER COMFORT
- \* STACKABLE FOR EASY STORAGE
- \* 36.25" H. x 16.25" W. x 18" DEPTH
- \* 1 YEAR LIMITED MANUFACTURER WARRANTY

CHR-8700	WHITE CHAIR WITH WHITE CUSHION
CHR-8701	DARK FRUITWOOD CHAIR WITH IVORY CUSHION
CHR-8702	GOLD CHAIR WITH IVORY CUSHION
CHR-8703	NATURAL CHAIR WITH IVORY CUSHION
CHR-8704	BLACK CHAIR WITH BLACK CUSHION
CHR-8705	MAHOGANY CHAIR WITH IVORY CUSHION
CHR-8706	SILVER CHAIR WITH WHITE CUSHION



### LUCCA X-BACK WOOD CHAIRS

- SOLD IN CASE PACK OF 12 EACH.
- FEATURES:
- \* STRONG, WOODEN FRAME WITH RUSTIC
- \* AVAILABLE IN NATURAL, RUSTIC, OR ANTIQUE
- \* STACKABLE
- \* USE WITH, OR WITHOUT A CUSHION
- \* ALSO KNOWN AS A "PILGRIM" CHAIR
- \* 35" H. X 19.75" W. X 10.25" DEPTH
- \* 1 YEAR LIMITED MANUFACTURER WARRANTY

CHR-8720	ANTIQUE X BACK ELM WOOD CHAIR
CHR-8721	NATURAL X BACK ELM WOOD CHAIR
CHR-8722	RUSTIC X BACK ELM WOOD CHAIR
CHR-8723	IVORY X BACK CHAIR CUSHION WITH TIES



### FOLDING CHAIRS

- SOLD IN CASE PACKS OF 20 ONLY!
- FEATURES:
- \* INJECTION-MOLDED PLASTIC SEAT AND BACK
- \* 18-GAUGE, 3/4-IN. TUBULAR STEEL FRAME
- \* BAKED ON POWDER ENAMEL
- \* ULTRAVIOLET ADDITIVES FOR SUPER PROTECTION
- \* TRIPLE RIVET BRACKETS AT THE SEAT FOR BETTER STRENGTH
- \* HIGH-DENSITY POLYETHYLENE COLOR BLENDED LEGS
- \* NON-MARRING REPLACEABLE FEET
- \* 3 YEAR LIMITED MANUFACTURER WARRANTY

CHR-8611	WHITE/WHITE, 31.5" H. x 17.75" W. x 19.5" DEPTH
CHR-8612	BLACK/BLACK, 31.5" H. x 17.75" W. x 19.5" DEPTH
CHR-8613	TAN/BROWN, 31.5" H. x 17.75" W. x 19.5" DEPTH



### FAN BACK CHAIRS

- SOLD IN CASE PACKS OF 24 ONLY!
- FEATURES:
- \* INJECTION-MOLDED PLASTIC SEAT AND BACK
- \* 18-GAUGE, 3/4-IN. TUBULAR STEEL FRAME
- \* BAKED ON POWDER ENAMEL
- \* ULTRAVIOLET ADDITIVES FOR SUPER PROTECTION
- \* HIGH-DENSITY POLYETHYLENE COLOR BLENDED LEGS
- \* NON-MARRING REPLACEABLE FEET

CHR-8620	WHITE/WHITE	34.25" H. X 17.5" W. X 21.25" DEPTH
CHR-8621	BLACK/BLACK	34.25" H. X 17.5" W. X 21.25" DEPTH



### WOODEN FOLDING CHAIRS WITH SOFT REMOVABLE VINYL SEAT CUSHIONS

- SOLD IN CASE PACKS OF 12 ONLY!
- FEATURES:
- \* MADE FROM HIGH-QUALITY, SOLID HARDWOOD
- \* PROTECTED WITH POLYURETHANE COATING
- \* SOFT, REMOVABLE AND REPLACEABLE VINYL SEAT CUSHIONS
- \* FOLD AND STACK THEM UP TO 35 CHAIRS HIGH
- \* THEY ARE INTERCHANGEABLE, INTERSTACKABLE
- \* 31" H. x 17.5" W. x 18.5" DEPTH
- \* 1 YEAR LIMITED MANUFACTURER WARRANTY

CHR-8600	WHITE WOOD FOLDING CHAIR WITH WHITE VINYL REMOVABLE CUSHION
CHR-8601	BLACK WOOD FOLDING CHAIR WITH BLACK VINYL REMOVABLE CUSHION
CHR-8602	MAHOGANY WOOD FOLDING CHAIR WITH IVORY VINYL REMOVABLE CUSHION
CHR-8603	FRUITWOOD WOOD FOLDING CHAIR WITH IVORY VINYL REMOVABLE CUSHION
CHR-8604	NATURAL WOOD FOLDING CHAIR WITH WHITE VINYL REMOVABLE CUSHION



## RESIN

### RESIN FOLDING CHAIRS

- SOLD IN CASE PACK OF 20 ONLY!
- FEATURES:
- \* MADE FROM 100-PERCENT POLYPROPYLENE RESIN
- \* ZINC COATED, NEVER-RUST SCREWS AND HARDWARE
- \* LOAD RESTS ON TWO SEAT BARS, NOT ON SCREWS
- \* SCREWS GO ALL THE WAY THROUGH LEGS
- \* HEAVY DUTY— SUPPORTS UP TO 1,000 LBS.
- \* COMFORTABLE, FLEXIBLE, PADDED FOAM SEAT
- \* SEAT SNAPS IN AND OUT FOR EASY CLEANING
- \* SIMPLE INTERLOCKING FEATURES FOR STACKING
- \* STAIN RESISTANT SURFACE; JUST WIPE CLEAN
- \* WEATHERPROOF AND UV PROTECTED TO PREVENT FADING
- \* STACK UP TO 30 CHAIRS ON A DOLLY
- \* 3 YEAR LIMITED MANUFACTURER WARRANTY

CHR-8640	WHITE, 30.75" H. x 17.5" W. x 18.5" DEPTH
CHR-8641	BLACK, 30.75" H. x 17.5" W. x 18.5" DEPTH
CHR-8642	MAHOGANY, 30.75" H. x 17.5" W. x 18.5" DEPTH



### STACK CHAIRS

- THESE STACKABLE CHAIRS CONTAIN 1" VINYL PADDED PLYWOOD SEATS AND A WELDED STEEL FRAME WITH SUPPORT BAR. POWDER COATED BLACK FINISH. SOLD IN MULTIPLES OF 2. 35" H. x 16" W. x 21" DEEP

CHR-4035	BLACK/BLACK PADDING
CHR-4036	BLACK/RED PADDING

# TABLES & DOLLIES

## WOOD FOLDING TABLES

**FEATURES:**

- \* TABLE TOPS BUILT WITH 3/4" THICK RUSSIAN BIRCHWOOD PLY
- \* "BLOND" COLOR TOPS WITH POLYURETHANE FINISH FOR PROTECTION
- \* TABLES 30 INCHES HIGH ("DINING HEIGHT") WHEN SET UP

- \* LOW MOISTURE TOPS FOR LONGER LIFE AND BETTER SERVICE
- \* FOLDING "WISHBONE" STYLE LEGS
- \* 16 GAUGE STEEL LEG TUBING WITH PLASTIC GLIDE INSERTS
- \* LEGS LOCK INTO PLACE WITH BOSS AND MATE MECHANISM

- \* BOLT THRU BUILD SECURELY ATTACHES RUNNERS & LEGS TO TOPS
- \* BLACK RUBBER BULL NOSE EDGING - EXCEPT ON METAL EDGING
- \* 3 YEAR LIMITED MANUFACTURER WARRANTY



ROUND TABLE



BANQUET TABLE



SQUARE TABLE



SERPENTINE TABLE

Model	Description	Case Pack
TAB-3500	36" ROUND FOLDING TABLE WITH BLACK VINYL EDGING	8 EACH
TAB-3501	48" ROUND FOLDING TABLE WITH BLACK VINYL EDGING	8 EACH
TAB-3502	60" ROUND FOLDING TABLE WITH BLACK VINYL EDGING	6 EACH
TAB-3503	60" ROUND FOLDING TABLE WITH METAL EDGING	6 EACH
TAB-3504	66" ROUND FOLDING TABLE WITH BLACK VINYL EDGING	6 EACH
TAB-3505	72" ROUND FOLDING TABLE WITH BLACK VINYL EDGING	6 EACH
TAB-3506	72" ROUND FOLDING TABLE WITH METAL EDGING	6 EACH

Model	Description	Case Pack
TAB-3510	48" X 30" BANQUET FOLDING TABLE WITH BLACK VINYL EDGING	8 EACH
TAB-3511	48" X 30" BANQUET FOLDING TABLE WITH METAL EDGING	8 EACH
TAB-3512	60" X 30" BANQUET FOLDING TABLE WITH METAL EDGING	8 EACH
TAB-3513	72" X 24" BANQUET FOLDING TABLE WITH METAL EDGING	8 EACH
TAB-3514	72" X 30" BANQUET FOLDING TABLE WITH BLACK VINYL EDGING	8 EACH
TAB-3515	72" X 30" BANQUET FOLDING TABLE WITH METAL EDGING	8 EACH
TAB-3516	72" X 36" BANQUET FOLDING TABLE WITH METAL EDGING	8 EACH
TAB-3517	96" X 24" BANQUET FOLDING TABLE WITH METAL EDGING	6 EACH
TAB-3518	96" X 30" BANQUET FOLDING TABLE WITH BLACK VINYL EDGING	6 EACH
TAB-3519	96" X 30" BANQUET FOLDING TABLE WITH METAL EDGING	6 EACH
TAB-3520	96" X 36" BANQUET FOLDING TABLE WITH METAL EDGING	6 EACH

Model	Description	Case Pack
TAB-3540	48" SQUARE WOOD FOLDING TABLE WITH BLACK VINYL EDGING	8 EACH
TAB-3541	60" SQUARE WOOD FOLDING TABLE WITH BLACK VINYL EDGING	8 EACH
TAB-3550	60" SERPENTINE WOOD FOLDING TABLE WITH BLACK VINYL EDGING	8 EACH



ROUND BLOW MOLD RESIN FOLDING TABLES

SOLD IN CASE PACKS ONLY!

**FEATURES:**

- \* LIGHTWEIGHT, AND EASY TO SET UP
- \* MADE WITH DURABLE RESIN TOPS
- \* STURDY DOUBLE-BRACED STEEL LEGS
- \* 400 LB. LOAD CAPACITY
- \* EASY TO WIPE CLEAN
- \* EASY STORAGE WITH FOLDING LEGS
- \* WEATHER RESISTANT
- \* 1 YEAR LIMITED MANUFACTURER WARRANTY



Model	Description	Case Pack
TAB-4530	48" ROUND FOLDING TABLE, 30" HEIGHT	8 EACH
TAB-4531	60" ROUND FOLDING TABLE, 30" HEIGHT	8 EACH
TAB-4532	72" ROUND FOLDING TABLE, 30" HEIGHT	6 EACH
TAB-4534	72" X 30" RECTANGULAR FOLDING TABLE, 30" HEIGHT	6 EACH
TAB-4535	96" X 30" RECTANGULAR FOLDING TABLE, 30" HEIGHT	6 EACH
TAB-4536	72" X 30" RECTANGULAR HALF FOLDING TABLE, 30" HEIGHT	6 EACH
TAB-4537	96" X 30" RECTANGULAR HALF FOLDING TABLE, 30" HEIGHT	6 EACH



WOOD COCKTAIL TABLES, 2 HEIGHTS IN ONE

SOLD IN CASE PACKS OF 8 ONLY!

**FEATURES:**

- \* BLACK, NYLON BASE MEASURES A 28" SPREAD
  - \* PEDESTAL STYLE TABLES, WITH BASE, POST, AND TOP
  - \* NO TOOLS NEEDED TO ASSEMBLE - JUST SET THE POST IN THE BASE AND TOP
  - \* WOOD TOPS HAVE POLYURETHANE FINISH AND VINYL EDGING
  - \* BASE IS MADE OF NYLON, FOR DURABILITY AND LONG LIFE
  - \* 3 YEAR LIMITED MANUFACTURER WARRANTY
- EACH TABLE KIT INCLUDES:  
(2) ONE PIECE POSTS FOR 30" HEIGHT AND 42" HEIGHT

TAB-4500	24" ROUND, ADJUSTS TO 30" OR 42" HEIGHT
TAB-4501	30" ROUND, ADJUSTS TO 30" OR 42" HEIGHT
TAB-4502	36" ROUND, ADJUSTS TO 30" OR 42" HEIGHT
TAB-4510	30" SQUARE, ADJUSTS TO 30" OR 42" HEIGHT
TAB-4511	36" SQUARE, ADJUSTS TO 30" OR 42" HEIGHT



CONFERENCE LAMINATE WOOD FOLDING TABLES

SOLD IN CASE PACKS OF 8 ONLY!

**FEATURES:**

- \* LAMINATE WOODEN PLY TOPS OFFER STRENGTH AND DURABILITY
- \* WISHBONE STYLE 16 GAUGE STEEL LEGS
- \* LEGS FOLD AND LOCK WITH BOSS AND MATE MECHANISM
- \* INSERTS IN LEGS PROTECT FLOOR SURFACE
- \* WHEN SET UP THE TABLES ARE 30 INCHES HIGH
- \* 3 YEAR LIMITED MANUFACTURER WARRANTY

TAB-3530	72" X 18" BLACK LAMINATE TOP WITH BLACK VINYL EDGING
TAB-3531	72" X 18" WOOD TOP WITH BLACK VINYL EDGING
TAB-3532	72" X 18" WOOD TOP WITH METAL EDGING
TAB-3533	96" X 18" BLACK LAMINATE TOP WITH BLACK VINYL EDGING
TAB-3534	96" X 18" WOOD TOP WITH BLACK VINYL EDGING
TAB-3535	96" X 18" WOOD TOP WITH METAL EDGING



CARPETED WOOD FRAME CHAIR DOLLY, 39" L. X 19" W.

SOLD IN CASE PACKS OF 12 ONLY!

**FEATURES:**

- \* STRONG WOOD FRAME WITH CARPET COVERING
- \* PROTECTS CHAIRS FROM SCRATCHES
- \* LARGE CASTERS FOR EASY TRANSPORT
- \* HOLDS 30 WOOD/RESIN FOLDING OR 70 PLASTIC FOLDING CHAIRS.
- \* STRAP OR SHRINK WRAP NEEDED AROUND CHAIRS BEFORE ROLLING
- \* LARGER THAN MOST SIZED PLATFORM FOR BETTER CHAIR PROTECTION
- \* 1 YEAR LIMITED MANUFACTURER WARRANTY



CHIAVARI CHAIR DOLLY

SOLD IN CASE PACKS OF 6 ONLY!

**FEATURES:**

- \* THE PERFECT CART FOR MOVING CHIAVARI CHAIRS
- \* MAXIMUM 10 CHAIR CAPACITY
- \* ALSO GOOD FOR MANY STYLES OF BANQUET CHAIRS
- \* BIG WHEELS MAKE FOR EASY TRANSPORT
- \* STURDY STEEL CONSTRUCTION FOR LONG SERVICE LIFE
- \* 1 YEAR LIMITED MANUFACTURER WARRANTY

CHRC-4200 55" H. X 30" D. X 18" W.

CHRC-4000 39" L. x 19" W.

BANQUET TABLE DOLLY

SOLD CASE PACKS OF 6 ONLY!

**FEATURES:**

- \* DURABLE HEAVY DUTY STEEL FRAME FOR LONG SERVICE LIFE
- \* TWO SIZES: FOR 6 FOOT TABLES OR 8 FOOT TABLES
- \* CAPACITY OF 12 TABLES - STRAP THEM IN BEFORE MOVING
- \* 2 SWIVEL AND 2 FIXED CASTERS FOR EASY MANEUVERING
- \* WORKS WELL WITH WOOD OR PLASTIC TABLES
- \* GOOD FOR STORAGE ALSO
- \* SHIPPED KD - ASSEMBLY REQUIRED
- \* 1 YEAR LIMITED MANUFACTURER WARRANTY

TABC-4200	TABLE DOLLY FOR 72" BANQUET TABLE
TABC-4201	TABLE DOLLY FOR 96" BANQUET TABLE



LARGE ROUND TABLE DOLLY

SOLD CASE PACKS OF 6 ONLY!

**FEATURES:**

- \* DOLLY FOR THE LARGER ROUND TABLES
- \* STURDY STEEL CONSTRUCTION FOR LONG SERVICE LIFE
- \* SIDE RAILS CONTAIN THE TABLES
- \* SIDE RAILS GIVE STRUCTURE TO PUSH/PULL
- \* SHIPPED KD - ASSEMBLY REQUIRED
- \* DOLLY HOLDS 8 TO 10 TABLES - JUST ROLL THEM UP FOR EASY MANEUVERABILITY
- \* LARGE CASTERS (2 SWIVEL, 2 FIXED)
- \* 1 YEAR LIMITED MANUFACTURER WARRANTY

TABC-4000 40.5" H. X 53" (W/O HANDLE) X 33" W.



# Supplying America's Finest Locations With Over 18,000 Products Nationwide!

Page 59



Page 125



Page 118



Page 101



Page 38



Page 128



Page 126



Page 82



Page 129



Page 3



Page 128



Page 59



Volume 2023



## Progressive Pro./Caterer's Warehouse

P.O. Box 400, Rochdale, MA 01542

Tel: 508-892-9618 FAX: 508-892-9745



# WWW.CATERERSWAREHOUSE.COM